

FEATURES

SNR = 78.3 dBFS at 70 MHz and 125 MSPS
 SFDR = 93 dBc at 70 MHz and 125 MSPS
 Low power: 371 mW at 125 MSPS
 1.8 V analog supply operation
 1.8 V CMOS or LVDS output supply
 Integer 1-to-8 input clock divider
 IF sampling frequencies to 300 MHz
 -153.4 dBm/Hz small signal input noise with 200 Ω input impedance at 70 MHz and 125 MSPS
 Optional on-chip dither
 Programmable internal ADC voltage reference
 Integrated ADC sample-and-hold inputs
 Flexible analog input range: 1 V p-p to 2 V p-p
 Differential analog inputs with 650 MHz bandwidth
 ADC clock duty cycle stabilizer
 Serial port control
 User-configurable, built-in self-test (BIST) capability
 Energy-saving power-down modes

APPLICATIONS

Communications
 Multimode digital receivers (3G)
 GSM, EDGE, W-CDMA, LTE, CDMA2000, WiMAX, and TD-SCDMA
Smart antenna systems
General-purpose software radios
Broadband data applications
Ultrasound equipment

PRODUCT HIGHLIGHTS

1. On-chip dither option for improved SFDR performance with low power analog input.
2. Proprietary differential input that maintains excellent SNR performance for input frequencies up to 300 MHz.
3. Operation from a single 1.8 V supply and a separate digital output driver supply accommodating 1.8 V CMOS or LVDS outputs.
4. Standard serial port interface (SPI) that supports various product features and functions, such as data formatting (offset binary, twos complement, or gray coding), enabling the clock DCS, power-down, test modes, and voltage reference mode.
5. Pin compatibility with the AD9265, allowing a simple migration up to 16 bits.

FUNCTIONAL BLOCK DIAGRAM

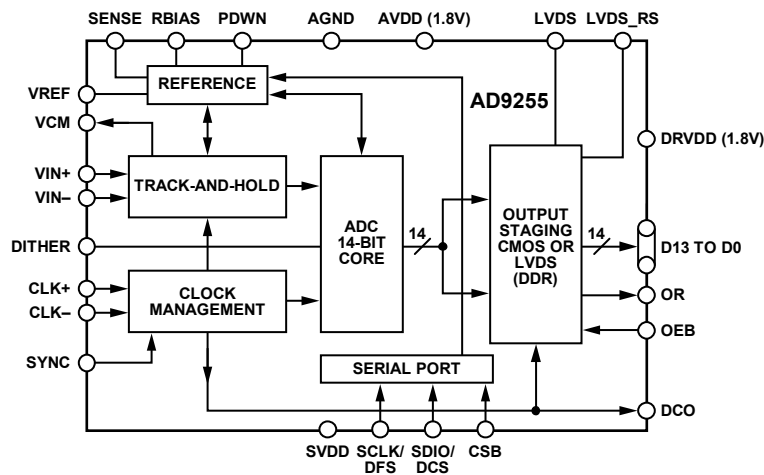

Figure 1.

Rev. D

[Document Feedback](#)

Information furnished by Analog Devices is believed to be accurate and reliable. However, no responsibility is assumed by Analog Devices for its use, nor for any infringements of patents or other rights of third parties that may result from its use. Specifications subject to change without notice. No license is granted by implication or otherwise under any patent or patent rights of Analog Devices. Trademarks and registered trademarks are the property of their respective owners.

One Technology Way, P.O. Box 9106, Norwood, MA 02062-9106, U.S.A.
 Tel: 781.329.4700 ©2009–2020 Analog Devices, Inc. All rights reserved.
[Technical Support](#) www.analog.com

TABLE OF CONTENTS

Features	1	Voltage Reference	28
Applications	1	Clock Input Considerations	29
Product Highlights	1	Power Dissipation and Standby Mode.....	31
Functional Block Diagram	1	Digital Outputs.....	32
Revision History	2	Timing	32
General Description	3	Built-In Self-Test (BIST) and Output Test	33
Specifications	4	Built-In Self-Test (BIST)	33
ADC DC Specifications	4	Output Test Modes	33
ADC AC Specifications	5	Serial Port Interface (SPI)	34
Digital Specifications	6	Configuration Using the SPI	34
Switching Specifications	8	Hardware Interface	34
Timing Specifications	9	Configuration Without the SPI.....	35
Absolute Maximum Ratings	10	SPI Accessible Features	35
Thermal Characteristics	10	Memory Map	36
ESD Caution.....	10	Reading the Memory Map Register Table	36
Pin Configurations and Function Descriptions.....	11	Memory Map Register Table	37
Typical Performance Characteristics.....	15	Memory Map Register Descriptions	39
Equivalent Circuits.....	23	Applications Information	40
Theory of Operation	25	Design Guidelines	40
ADC Architecture	25	Outline Dimensions.....	41
Analog Input Considerations	25	Ordering Guide	41

REVISION HISTORY

9/2020—Rev. C to Rev. D

Changed CP-48-8 to CP-48-9.....	Throughout
Changes to Figure 4.....	11
Updated Outline Dimensions.....	61
Changes to Ordering Guide.....	61

7/2013—Rev. B to Rev. C

Changes to Data Clock Output (DCO) Section	32
--	----

3/2013—Rev. A to Rev. B

Changes to Table 17	1
Updated Outline Dimensions.....	41

1/2010—Rev. 0 to Rev. A

Changes to Worst Other (Harmonic or Spur) Parameter, Table 2.....	6
Changes to Figure 77	29
Changes to Input Clock Divider Section	30
Changes to Table 17	37
Updated Outline Dimensions.....	41

10/2009—Revision 0: Initial Version

GENERAL DESCRIPTION

The AD9255 is a 14-bit, 125 MSPS analog-to-digital converter (ADC). The AD9255 is designed to support communications applications where high performance combined with low cost, small size, and versatility is desired.

The ADC core features a multistage, differential pipelined architecture with integrated output error correction logic to provide 14-bit accuracy at 125 MSPS data rates and guarantees no missing codes over the full operating temperature range.

The ADC features a wide bandwidth differential sample-and-hold analog input amplifier supporting a variety of user-selectable input ranges. It is suitable for multiplexed systems that switch full-scale voltage levels in successive channels and for sampling single-channel inputs at frequencies well beyond the Nyquist rate.

Combined with power and cost savings over previously available ADCs, the AD9255 is suitable for applications in communications, instrumentation, and medical imaging.

A differential clock input controls all internal conversion cycles. A duty cycle stabilizer provides the means to compensate for variations in the ADC clock duty cycle, allowing the converters to maintain excellent performance over a wide range of input clock duty cycles. An integrated voltage reference eases design considerations.

The ADC output data format is either parallel 1.8 V CMOS or LVDS (DDR). A data output clock is provided to ensure proper latch timing with receiving logic.

Programming for setup and control is accomplished using a 3-wire SPI-compatible serial interface. Flexible power-down options allow significant power savings, when desired. An optional on-chip dither function is available to improve SFDR performance with low power analog input signals.

The AD9255 is available in a Pb-free, 48-lead LFCSP and is specified over the industrial temperature range of -40°C to $+85^{\circ}\text{C}$.

SPECIFICATIONS

ADC DC SPECIFICATIONS

AVDD = 1.8 V, DRVDD = 1.8 V, SVDD = 1.8 V, maximum sample rate, VIN = -1.0 dBFS differential input, 1.0 V internal reference, DCS enabled, unless otherwise noted.

Table 1.

Parameter	Temp	AD9255BCPZ-80 ¹			AD9255BCPZ-105 ¹			AD9255BCPZ-125 ¹			Unit
		Min	Typ	Max	Min	Typ	Max	Min	Typ	Max	
RESOLUTION	Full	14			14			14			Bits
ACCURACY		Guaranteed			Guaranteed			Guaranteed			
No Missing Codes	Full	Guaranteed			Guaranteed			Guaranteed			
Offset Error	Full		±0.05	±0.25		±0.05	±0.25		±0.05	±0.25	% FSR
Gain Error	Full		±0.2	±2.5		±0.2	±2.5		±0.4	±2.5	% FSR
Differential Nonlinearity (DNL) ²	Full			±0.4			±0.4			±0.45	LSB
	25°C		±0.2			±0.2			±0.25		LSB
Integral Nonlinearity (INL) ²	Full			±0.9			±0.9			±1.2	LSB
	25°C		±0.35			±0.45			±0.7		LSB
TEMPERATURE DRIFT											
Offset Error	Full		±2			±2			±2		ppm/°C
Gain Error	Full		±15			±15			±15		ppm/°C
INTERNAL VOLTAGE REFERENCE											
Output Voltage Error (1 V Mode)	Full		+8	±12		+8	±12		+8	±12	mV
Load Regulation at 1.0 mA	Full		3			3			3		mV
INPUT REFERRED NOISE											
VREF = 1.0 V	25°C		0.62			0.63			0.61		LSB rms
ANALOG INPUT											
Input Span, VREF = 1.0 V	Full		2			2			2		V p-p
Input Capacitance ³	Full		8			8			8		pF
Input Common-Mode Voltage	Full		0.9			0.9			0.9		V
REFERENCE INPUT RESISTANCE	Full		6			6			6		kΩ
POWER SUPPLIES											
Supply Voltage											
AVDD	Full	1.7	1.8	1.9	1.7	1.8	1.9	1.7	1.8	1.9	V
DRVDD	Full	1.7	1.8	1.9	1.7	1.8	1.9	1.7	1.8	1.9	V
SVDD	Full	1.7		3.5	1.7		3.5	1.7		3.5	V
Supply Current											
IAVDD ²	Full		126	131		169	176		194	202	mA
IDRVDD ² (1.8 V CMOS)	Full		13			19			23		mA
IDRVDD ² (1.8 V LVDS)	Full		39			42			44		mA
POWER CONSUMPTION											
DC Input	Full		239	248		321	332		371	382	mW
Sine Wave Input ²											
CMOS Output Mode	Full		252			338			391		mW
LVDS Output Mode	Full		306			384			437		mW
Standby Power ⁴	Full		54			54			54		mW
Power-Down Power	Full		0.05	0.15		0.05	0.15		0.05	0.15	mW

¹ The suffix following the part number refers to the model found in the Ordering Guide section.

² Measured with a low input frequency, full-scale sine wave, with approximately 5 pF loading on each output bit.

³ Input capacitance refers to the effective capacitance between one differential input pin and AGND.

⁴ Standby power is measured with a dc input, the CLK pins (CLK+, CLK-) inactive (set to AVDD or AGND).

ADC AC SPECIFICATIONS

AVDD = 1.8 V, DRVDD = 1.8 V, SVDD = 1.8 V, maximum sample rate, VIN = -1.0 dBFS differential input, 1.0 V internal reference, DCS enabled, unless otherwise noted.

Table 2.

Parameter ¹	Temp	AD9255BCPZ-80 ²			AD9255BCPZ-105 ²			AD9255BCPZ-125 ²			Unit
		Min	Typ	Max	Min	Typ	Max	Min	Typ	Max	
SIGNAL-TO-NOISE-RATIO (SNR)											
$f_{IN} = 2.4$ MHz	25°C		79.2			78.9			78.3		dBFS
$f_{IN} = 70$ MHz	25°C		78.9			78.5			78.3		dBFS
	Full	78.1			77.6			76.9			dBFS
$f_{IN} = 140$ MHz	25°C		78.0			77.7			77.1		dBFS
$f_{IN} = 200$ MHz	25°C		76.9			76.4			75.5		dBFS
SIGNAL-TO-NOISE-AND DISTORTION (SINAD)											
$f_{IN} = 2.4$ MHz	25°C		78.7			78.6			78.0		dBFS
$f_{IN} = 70$ MHz	25°C		78.7			78.0			78.0		dBFS
	Full	77.9			77.3			76.7			dBFS
$f_{IN} = 140$ MHz	25°C		76.8			77.0			76.7		dBFS
$f_{IN} = 200$ MHz	25°C		75.8			75.3			74.3		dBFS
EFFECTIVE NUMBER OF BITS (ENOB)											
$f_{IN} = 2.4$ MHz	25°C		12.8			12.8			12.7		Bits
$f_{IN} = 70$ MHz	25°C		12.8			12.7			12.7		Bits
$f_{IN} = 140$ MHz	25°C		12.5			12.5			12.4		Bits
$f_{IN} = 200$ MHz	25°C		12.3			12.2			12.0		Bits
WORST SECOND OR THIRD HARMONIC											
$f_{IN} = 2.4$ MHz	25°C		-88			-90			-88		dBc
$f_{IN} = 70$ MHz	25°C		-94			-89			-93		dBc
	Full			-91			-88			-85	dBc
$f_{IN} = 140$ MHz	25°C		-82			-86			-89		dBc
$f_{IN} = 200$ MHz	25°C		-81			-81			-80		dBc
SPURIOUS-FREE DYNAMIC RANGE (SFDR)											
$f_{IN} = 2.4$ MHz	25°C		88			90			88		dBc
$f_{IN} = 70$ MHz	25°C		94			89			93		dBc
	Full	91			88			85			dBc
$f_{IN} = 140$ MHz	25°C		82			86			89		dBc
$f_{IN} = 200$ MHz	25°C		81			81			80		dBc
SPURIOUS-FREE DYNAMIC RANGE (SFDR)											
Without Dither (AIN at -23 dBFS)											
$f_{IN} = 2.4$ MHz	25°C		102			99			96		dBFS
$f_{IN} = 70$ MHz	25°C		103			97			99		dBFS
$f_{IN} = 140$ MHz	25°C		104			97			98		dBFS
$f_{IN} = 200$ MHz	25°C		102			101			97		dBFS
With On-Chip Dither (AIN at -23 dBFS)											
$f_{IN} = 2.4$ MHz	25°C		110			109			108		dBFS
$f_{IN} = 70$ MHz	25°C		110			108			109		dBFS
$f_{IN} = 140$ MHz	25°C		110			108			109		dBFS
$f_{IN} = 200$ MHz	25°C		110			109			109		dBFS

Parameter ¹	Temp	AD9255BCPZ-80 ²			AD9255BCPZ-105 ²			AD9255BCPZ-125 ²			Unit
		Min	Typ	Max	Min	Typ	Max	Min	Typ	Max	
WORST OTHER (HARMONIC OR SPUR)											
Without Dither											
$f_{IN} = 2.4$ MHz	25°C		-106			-105			-101		dBc
$f_{IN} = 70$ MHz	25°C		-106			-104			-104		dBc
	Full			-94			-95			-91	dBc
$f_{IN} = 140$ MHz	25°C		-104			-104			-103		dBc
$f_{IN} = 200$ MHz	25°C		-102			-103			-100		dBc
With On-Chip Dither											
$f_{IN} = 2.4$ MHz	25°C		-105			-106			-101		dBc
$f_{IN} = 70$ MHz	25°C		-106			-105			-104		dBc
	Full			-97			-99			-98	dBc
$f_{IN} = 140$ MHz	25°C		-103			-103			-103		dBc
$f_{IN} = 200$ MHz	25°C		-100			-101			-100		dBc
TWO-TONE SFDR											
Without Dither											
$f_{IN} = 29$ MHz (-7 dBFS), 32 MHz (-7 dBFS)	25°C		93			90			95		dBc
$f_{IN} = 169$ MHz (-7 dBFS), 172 MHz (-7 dBFS)	25°C		80			78			79		dBc
ANALOG INPUT BANDWIDTH											
	25°C		650			650			650		MHz

¹ See the AN-835 Application Note, *Understanding High Speed ADC Testing and Evaluation*, for a complete set of definitions.

² The suffix following the part number refers to the model found in the Ordering Guide section.

DIGITAL SPECIFICATIONS

AVDD = 1.8 V, DRVDD = 1.8 V, SVDD = 1.8 V, maximum sample rate, VIN = -1.0 dBFS differential input, 1.0 V internal reference, and DCS enabled, unless otherwise noted.

Table 3.

Parameter	Temperature	Min	Typ	Max	Unit
DIFFERENTIAL CLOCK INPUTS (CLK+, CLK-)					
Logic Compliance			CMOS/LVDS/LVPECL		
Internal Common-Mode Bias	Full		0.9		V
Differential Input Voltage	Full	0.3		3.6	V p-p
Input Voltage Range	Full	AGND		AVDD	V
Input Common-Mode Range	Full	0.9		1.4	V
High Level Input Current	Full	-100		+100	μA
Low Level Input Current	Full	-100		+100	μA
Input Capacitance	Full		4		pF
Input Resistance	Full	8	10	12	kΩ
SYNC INPUT					
Logic Compliance			CMOS		
Internal Bias	Full		0.9		V
Input Voltage Range	Full	AGND		AVDD	V
High Level Input Voltage	Full	1.2		AVDD	V
Low Level Input Voltage	Full	AGND		0.6	V
High Level Input Current	Full	-100		+100	μA
Low Level Input Current	Full	-100		+100	μA
Input Capacitance	Full		1		pF
Input Resistance	Full	12	16	20	kΩ

Parameter	Temperature	Min	Typ	Max	Unit
LOGIC INPUT (CSB)¹					
High Level Input Voltage	Full	1.22		SVDD	V
Low Level Input Voltage	Full	0		0.6	V
High Level Input Current	Full	-10		+10	μA
Low Level Input Current	Full	40		132	μA
Input Resistance	Full		26		kΩ
Input Capacitance	Full		2		pF
LOGIC INPUT (SCLK/DFS)²					
High Level Input Voltage	Full	1.22		SVDD	V
Low Level Input Voltage	Full	0		0.6	V
High Level Input Current (VIN = 1.8 V)	Full	-92		-135	μA
Low Level Input Current	Full	-10		+10	μA
Input Resistance	Full		26		kΩ
Input Capacitance	Full		2		pF
LOGIC INPUT/OUTPUT (SDIO/DCS)¹					
High Level Input Voltage	Full	1.22		SVDD	V
Low Level Input Voltage	Full	0		0.6	V
High Level Input Current	Full	-10		+10	μA
Low Level Input Current	Full	38		128	μA
Input Resistance	Full		26		kΩ
Input Capacitance	Full		5		pF
High Level Output Voltage	Full	1.70			V
Low Level Output Voltage	Full			0.2	V
LOGIC INPUTS (OEB, PDWN, DITHER, LVDS, LVDS_RS)²					
High Level Input Voltage	Full	1.22		2.1	V
Low Level Input Voltage	Full	0		0.6	V
High Level Input Current (VIN = 1.8 V)	Full	-90		-134	μA
Low Level Input Current	Full	-10		+10	μA
Input Resistance	Full		26		kΩ
Input Capacitance	Full		5		pF
DIGITAL OUTPUTS (DRVDD = 1.8 V)					
CMOS Mode					
High Level Output Voltage					
I _{OH} = 50 μA	Full	1.79			V
I _{OH} = 0.5 mA	Full	1.75			V
Low Level Output Voltage					
I _{OL} = 1.6 mA	Full			0.2	V
I _{OL} = 50 μA	Full			0.05	V
LVDS Mode					
ANSI Mode					
Differential Output Voltage (V _{OD})	Full	290	345	400	mV
Output Offset Voltage (V _{OS})	Full	1.15	1.25	1.35	V
Reduced Swing Mode					
Differential Output Voltage (V _{OD})	Full	160	200	230	mV
Output Offset Voltage (V _{OS})	Full	1.15	1.25	1.35	V

¹ Pull-up.² Pull-down.

SWITCHING SPECIFICATIONS

AVDD = 1.8 V, DRVDD = 1.8 V, SVDD = 1.8 V, maximum sample rate, VIN = -1.0 dBFS differential input, 1.0 V internal reference, and DCS enabled, unless otherwise noted.

Table 4.

Parameter	Temp	AD9255BCPZ-80 ¹			AD9255BCPZ-105 ¹			AD9255BCPZ-125 ¹			Unit
		Min	Typ	Max	Min	Typ	Max	Min	Typ	Max	
CLOCK INPUT PARAMETERS											
Input Clock Rate	Full			625			625			625	MHz
Conversion Rate ²											
DCS Enabled	Full	20		80	20		105	20		125	MSPS
DCS Disabled	Full	10		80	10		105	10		125	MSPS
CLK Period—Divide-by-1 Mode (t _{CLK})	Full	12.5			9.5			8			ns
CLK Pulse Width High (t _{CH})											
Divide-by-1 Mode											
DCS Enabled	Full	3.75	6.25	8.75	2.85	4.75	6.65	2.4	4	5.6	ns
DCS Disabled		5.9	6.25	6.6	4.5	4.75	5.0	3.8	4	4.2	ns
Divide-by-3 Mode, Divide-by-5 Mode, and Divide-by-7 Mode, DCS Enabled ³	Full	0.8			0.8			0.8			ns
Divide-by-2 Mode, Divide-by-4 Mode, Divide-by-6 Mode, and Divide-by-8 Mode, DCS Enabled or DCS Disabled ³	Full	0.8			0.8			0.8			ns
Aperture Delay (t _A)	Full		1.0			1.0			1.0		ns
Aperture Uncertainty (Jitter, t _J)	Full		0.07			0.07			0.07		ps rms
DATA OUTPUT PARAMETERS											
CMOS Mode											
Data Propagation Delay (t _{PD})	Full	2.4	2.8	3.4	2.4	2.8	3.4	2.4	2.8	3.4	ns
DCO Propagation Delay (t _{DCO}) ⁴	Full	2.7	3.4	4.2	2.7	3.4	4.2	2.7	3.4	4.2	ns
DCO to Data Skew (t _{SKEW})	Full	0.3	0.6	0.9	0.3	0.6	0.9	0.3	0.6	0.9	ns
Pipeline Delay (Latency)	Full		12			12			12		Cycles
LVDS Mode											
Data Propagation Delay (t _{PD})	Full	2.6	3.4	4.2	2.6	3.4	4.2	2.6	3.4	4.2	ns
DCO Propagation Delay (t _{DCO}) ⁴	Full	3.3	3.8	4.3	3.3	3.8	4.3	3.3	3.8	4.3	ns
DCO to Data Skew (t _{SKEW})		-0.3	+0.4	+1.2	-0.3	+0.4	+1.2	-0.3	+0.4	+1.2	
Pipeline Delay (Latency)	Full		12.5			12.5			12.5		Cycles
Wake-Up Time ⁵	Full		500			500			500		μs
OUT-OF-RANGE RECOVERY TIME	Full		2			2			2		Cycles

¹ The suffix following the part number refers to the model found in the Ordering Guide section.

² Conversion rate is the clock rate after the divider.

³ See the Input Clock Divider section for additional information on using the DCS with the input clock divider.

⁴ Additional DCO delay can be added by writing to Bit 0 through Bit 4 in SPI Register 0x17 (see Table 17).

⁵ Wake-up time is defined as the time required to return to normal operation from power-down mode.

TIMING SPECIFICATIONS

Table 5.

Parameter	Conditions	Min	Typ	Max	Unit
SYNC TIMING REQUIREMENTS					
t_{SSYNC}	SYNC to rising edge of CLK setup time		0.30		ns
t_{HSYNC}	SYNC to rising edge of CLK hold time		0.40		ns
SPI TIMING REQUIREMENTS¹					
t_{DS}	Setup time between the data and the rising edge of SCLK	2			ns
t_{DH}	Hold time between the data and the rising edge of SCLK	2			ns
t_{CLK}	Period of the SCLK	40			ns
t_S	Setup time between CSB and SCLK	2			ns
t_H	Hold time between CSB and SCLK	2			ns
t_{HIGH}	SCLK pulse width high	10			ns
t_{LOW}	SCLK pulse width low	10			ns
t_{EN_SDIO}	Time required for the SDIO pin to switch from an input to an output relative to the SCLK falling edge	10			ns
t_{DIS_SDIO}	Time required for the SDIO pin to switch from an output to an input relative to the SCLK rising edge	10			ns

¹ Refer to Figure 84 for a detailed timing diagram.

Timing Diagrams

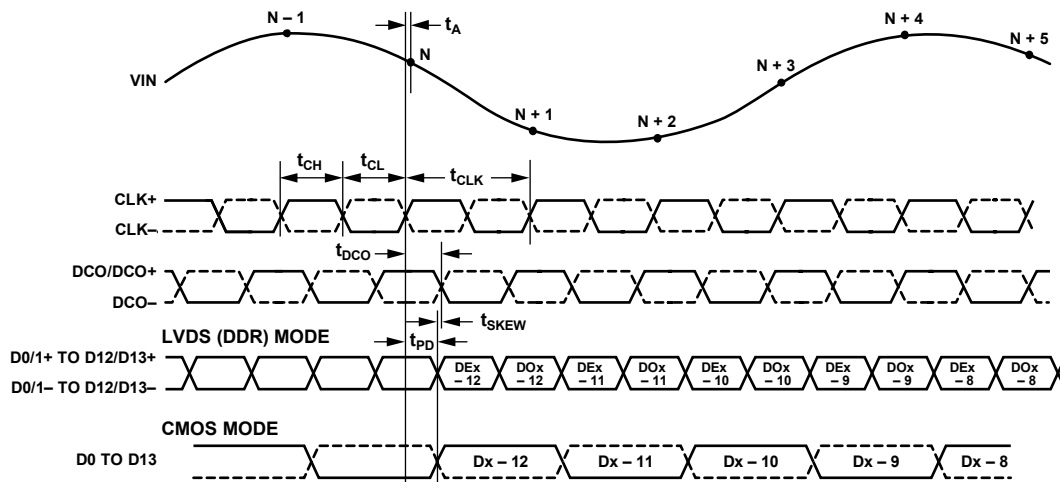

NOTES
 1. DEx DENOTES EVEN BIT.
 2. DOx DENOTES ODD BIT.

Figure 2. LVDS (DDR) and CMOS Output Mode Data Output Timing

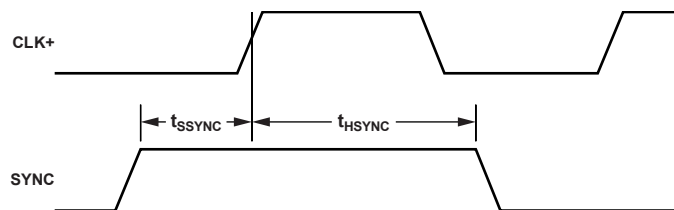

Figure 3. SYNC Input Timing Requirements

ABSOLUTE MAXIMUM RATINGS

Table 6.

Parameter	Rating
Electrical	
AVDD to AGND	−0.3 V to +2.0 V
DRVDD to AGND	−0.3 V to +2.0V
SVDD to AGND	−0.3 V to +3.6 V
VIN+, VIN− to AGND	−0.3 V to AVDD + 0.2 V
CLK+, CLK− to AGND	−0.3 V to AVDD + 0.2 V
SYNC to AGND	−0.3 V to AVDD + 0.2 V
VREF to AGND	−0.3 V to AVDD + 0.2 V
SENSE to AGND	−0.3 V to AVDD + 0.2 V
VCM to AGND	−0.3 V to AVDD + 0.2 V
RBIAS to AGND	−0.3 V to AVDD + 0.2 V
CSB to AGND	−0.3 V to SVDD +0.3 V
SCLK/DFS to AGND	−0.3 V to SVDD +0.3 V
SDIO/DCS to AGND	−0.3V to SVDD + 0.3 V
OEB to AGND	−0.3 V to DRVDD + 0.2 V
PDWN to AGND	−0.3 V to DRVDD + 0.2 V
LVDS to AGND	−0.3 V to AVDD + 0.2 V
LVDS_RS to AGND	−0.3 V to AVDD + 0.2 V
DITHER to AGND	−0.3 V to AVDD + 0.2 V
D0 through D13 to AGND	−0.3 V to DRVDD + 0.2 V
DCO to AGND	−0.3 V to DRVDD + 0.2 V
Environmental	
Operating Temperature Range (Ambient)	−40°C to +85°C
Maximum Junction Temperature Under Bias	150°C
Storage Temperature Range (Ambient)	−65°C to +150°C

Stresses above those listed under Absolute Maximum Ratings may cause permanent damage to the device. This is a stress rating only; functional operation of the device at these or any other conditions above those indicated in the operational section of this specification is not implied. Exposure to absolute maximum rating conditions for extended periods may affect device reliability.

THERMAL CHARACTERISTICS

The exposed paddle must be soldered to the ground plane for the LFCSP package. Soldering the exposed paddle to the customer board increases the reliability of the solder joints and maximizes the thermal capability of the package.

Typical θ_{JA} is specified for a 4-layer PCB with a solid ground plane. As shown, airflow improves heat dissipation, which reduces θ_{JA} . In addition, metal in direct contact with the package leads from metal traces, through holes, ground, and power planes, reduces the θ_{JA} .

Table 7. Thermal Resistance

Package Type	Airflow Velocity (m/s)	$\theta_{JA}^{1,2}$	$\theta_{JC}^{1,3}$	$\theta_{JB}^{1,4}$	Unit
48-Lead LFCSP (CP-48-8)	0	24.5	1.3	12.7	°C/W
	1.0	21.4			°C/W
	2.5	19.2			°C/W

¹ Per JEDEC 51-7, plus JEDEC 25-5 2S2P test board.

² Per JEDEC JESD51-2 (still air) or JEDEC JESD51-6 (moving air).

³ Per MIL-Std 883, Method 1012.1.

⁴ Per JEDEC JESD51-8 (still air).

ESD CAUTION



ESD (electrostatic discharge) sensitive device.

Charged devices and circuit boards can discharge without detection. Although this product features patented or proprietary protection circuitry, damage may occur on devices subjected to high energy ESD. Therefore, proper ESD precautions should be taken to avoid performance degradation or loss of functionality.

PIN CONFIGURATIONS AND FUNCTION DESCRIPTIONS

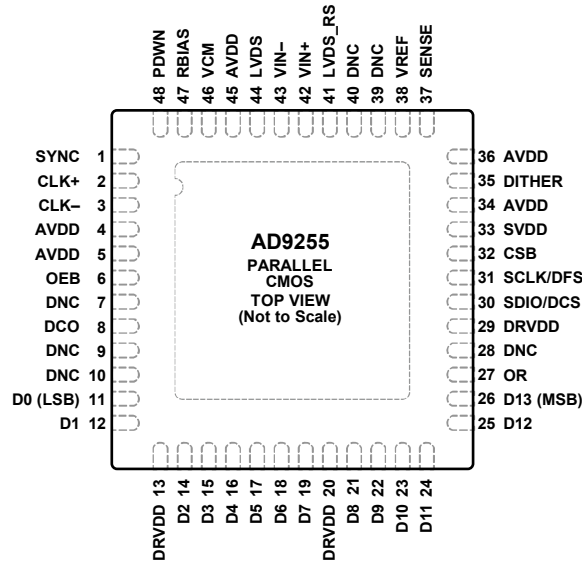

- NOTES
1. DNC = DO NOT CONNECT.
 2. THE EXPOSED THERMAL PAD ON THE BOTTOM OF THE PACKAGE PROVIDES THE ANALOG GROUND FOR THE INPUT. THIS EXPOSED PAD MUST BE CONNECTED TO GROUND FOR PROPER OPERATION.

08565-003

Figure 4. LFCSP Parallel CMOS Pin Configuration (Top View)

Table 8. Pin Function Descriptions (Parallel CMOS Mode)

Pin No.	Mnemonic	Type	Description
ADC Power Supplies			
13, 20, 29	DRVDD	Supply	Digital Output Driver Supply (1.8 V Nominal).
4, 5, 34, 36, 45	AVDD	Supply	Analog Power Supply (1.8 V Nominal).
33	SVDD	Supply	SPI Input/Output Voltage
7, 9, 10, 28, 39, 40	DNC		Do Not Connect.
0	AGND	Ground	Analog Ground. The exposed thermal pad on the bottom of the package provides the analog ground for the input. This exposed pad must be connected to ground for proper operation.
ADC Analog			
42	VIN+	Input	Differential Analog Input Pin (+).
43	VIN-	Input	Differential Analog Input Pin (-).
38	VREF	Input/output	Voltage Reference Input/Output.
37	SENSE	Input	Voltage Reference Mode Select. See Table 11 for details.
47	RBIAS	Input/output	External Reference Bias Resistor.
46	VCM	Output	Common-Mode Level Bias Output for Analog Inputs.
2	CLK+	Input	ADC Clock Input—True.
3	CLK-	Input	ADC Clock Input—Complement.
Digital Input			
1	SYNC	Input	Digital Synchronization Pin. Slave mode only.
Digital Outputs			
11	D0 (LSB)	Output	CMOS Output Data.
12	D1	Output	CMOS Output Data.
14	D2	Output	CMOS Output Data.
15	D3	Output	CMOS Output Data.
16	D4	Output	CMOS Output Data.
17	D5	Output	CMOS Output Data.
18	D6	Output	CMOS Output Data.
19	D7	Output	CMOS Output Data.
21	D8	Output	CMOS Output Data.

Pin No.	Mnemonic	Type	Description
22	D9	Output	CMOS Output Data.
23	D10	Output	CMOS Output Data.
24	D11	Output	CMOS Output Data.
25	D12	Output	CMOS Output Data.
26	D13 (MSB)	Output	CMOS Output Data.
27	OR	Output	Ovrange Output.
8	DCO	Output	Data Clock Output.
SPI Control			
31	SCLK/DFS	Input	SPI Serial Clock/Data Format Select Pin in External Pin Mode.
30	SDIO/DCS	Input/output	SPI Serial Data I/O/Duty Cycle Stabilizer Pin in External Pin Mode.
32	CSB	Input	SPI Chip Select (Active Low).
ADC Configuration			
6	OEB	Input	Output Enable Input (Active Low).
35	DITHER	Input	In external pin mode, this pin sets dither to on (active high). Pull low for control via SPI in SPI mode.
41	LVDS_RS	Input	In external pin mode, this pin sets LVDS reduced swing output mode (active high). Pull low for control via SPI in SPI mode.
44	LVDS	Input	In external pin mode, this pin sets LVDS output mode (active high). Pull low for control via SPI in SPI mode.
48	PDWN	Input	Power-down input in external pin mode. In SPI mode, this input can be configured as power-down or standby.

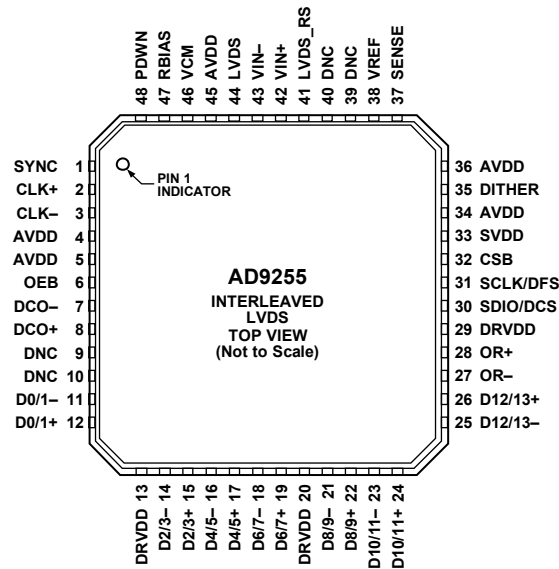

NOTES
 1. DNC = DO NOT CONNECT.
 2. THE EXPOSED THERMAL PAD ON THE BOTTOM OF THE PACKAGE PROVIDES THE ANALOG GROUND FOR THE PART. THIS EXPOSED PAD MUST BE CONNECTED TO GROUND FOR PROPER OPERATION.

Figure 5. LFCSP Interleaved Parallel LVDS Pin Configuration (Top View)

Table 9. Pin Function Descriptions (Interleaved Parallel LVDS Mode)

Pin No.	Mnemonic	Type	Description
ADC Power Supplies			
13, 20, 29	DRVDD	Supply	Digital Output Driver Supply (1.8 V Nominal).
4, 5, 34, 36, 45	AVDD	Supply	Analog Power Supply (1.8 V Nominal).
33	SVDD	Supply	SPI Input/Output Voltage.
9, 10, 39, 40	DNC		Do Not Connect.
0	AGND	Ground	Analog Ground. The exposed thermal pad on the bottom of the package provides the analog ground for the input. This exposed pad must be connected to ground for proper operation.
ADC Analog			
42	VIN+	Input	Differential Analog Input Pin (+).
43	VIN-	Input	Differential Analog Input Pin (-).
38	VREF	Input/output	Voltage Reference Input/Output.
37	SENSE	Input	Voltage Reference Mode Select. See Table 11 for details.
47	RBIAS	Input/output	External Reference Bias Resistor.
46	VCM	Output	Common-Mode Level Bias Output for Analog Inputs.
2	CLK+	Input	ADC Clock Input—True.
3	CLK-	Input	ADC Clock Input—Complement.
Digital Input			
1	SYNC	Input	Digital Synchronization Pin. Slave mode only.
Digital Outputs			
12	D0/1+	Output	LVDS Output Data Bit 0/Bit 1 (LSB)—True.
11	D0/1-	Output	LVDS Output Data Bit 0/Bit 1 (LSB)—Complement.
15	D2/3+	Output	LVDS Output Data Bit 2/Bit 3—True.
14	D2/3-	Output	LVDS Output Data Bit 2/Bit 3—Complement.
17	D4/5+	Output	LVDS Output Data Bit 4/Bit 5—True.
16	D4/5-	Output	LVDS Output Data Bit 4/Bit 5—Complement.
19	D6/7+	Output	LVDS Output Data Bit 6/Bit 7—True.
18	D6/7-	Output	LVDS Output Data Bit 6/Bit 7—Complement.
22	D8/9+	Output	LVDS Output Data Bit 8/Bit 9—True.
21	D8/9-	Output	LVDS Output Data Bit 8/Bit 9—Complement.

Pin No.	Mnemonic	Type	Description
24	D10/11+	Output	LVDS Output Data Bit 10/Bit 11—True.
23	D10/11–	Output	LVDS Output Data Bit 10/Bit 11—Complement.
26	D12/13+ (MSB)	Output	LVDS Output Data Bit 12/Bit 13—True.
25	D12/13– (MSB)	Output	LVDS Output Data Bit 12/Bit 13—Complement.
28	OR+	Output	LVDS Overage Output—True.
27	OR–	Output	LVDS Overage Output—Complement.
8	DCO+	Output	LVDS Data Clock Output—True.
7	DCO–	Output	LVDS Data Clock Output—Complement.
SPI Control			
31	SCLK/DFS	Input	SPI Serial Clock/Data Format Select Pin in External Pin Mode.
30	SDIO/DCS	Input/output	SPI Serial Data I/O/Duty Cycle Stabilizer Pin in External Pin Mode.
32	CSB	Input	SPI Chip Select (Active Low).
ADC Configuration			
6	OEB	Input	Output Enable Input (Active Low).
35	DITHER	Input	In external pin mode, this pin sets dither to on (active high). Pull low for control via SPI in the SPI mode.
41	LVDS_RS	Input	In external pin mode, this pin sets LVDS reduced swing output mode (active high). Pull low for control via SPI in the SPI mode.
44	LVDS	Input	In external pin mode, this pin sets LVDS output mode (active high). Pull low for control via SPI in the SPI mode.
48	PDWN	Input	Power-Down Input in External Pin Mode. In SPI mode, this input can be configured as power-down or standby.

TYPICAL PERFORMANCE CHARACTERISTICS

AVDD = 1.8 V, DRVDD = 1.8 V, SVDD = 1.8 V, sample rate = 125 MSPS, DCS enabled, 1.0 V internal reference, 2 V p-p differential input, VIN = -1.0 dBFS, and 32k sample, TA = 25°C, unless otherwise noted.

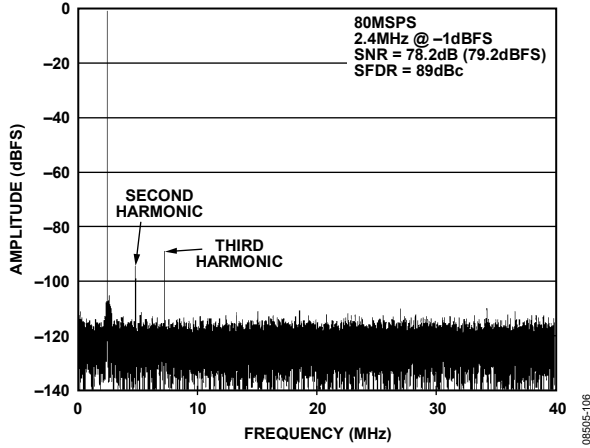

Figure 6. AD9255-80 Single-Tone FFT with $f_{IN} = 2.4$ MHz

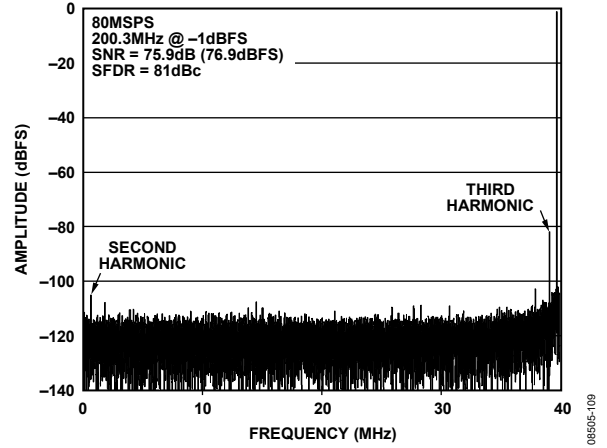

Figure 9. AD9255-80 Single-Tone FFT with $f_{IN} = 200.3$ MHz

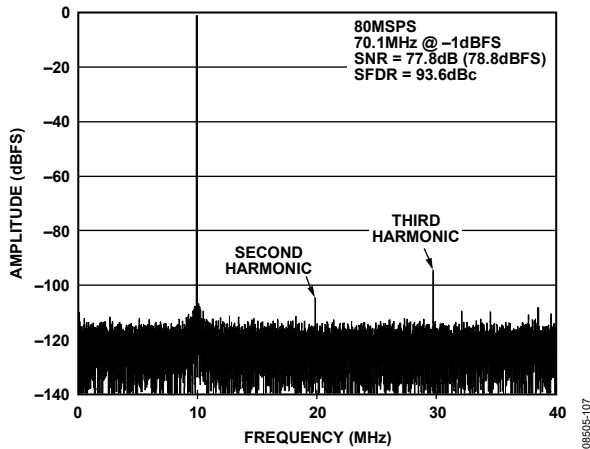

Figure 7. AD9255-80 Single-Tone FFT with $f_{IN} = 70.1$ MHz

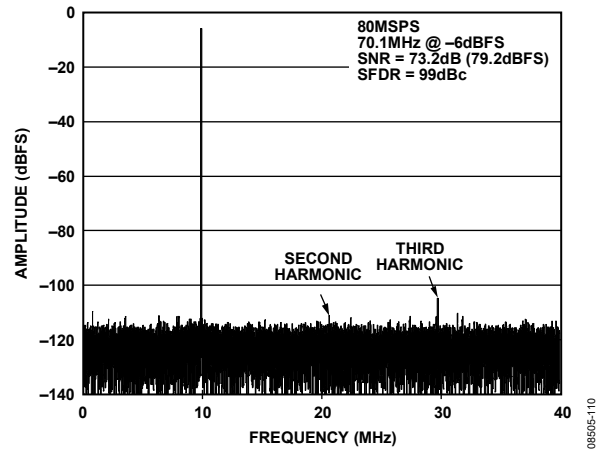

Figure 10. AD9255-80 Single-Tone FFT with $f_{IN} = 70.1$ MHz at -6 dBFS with Dither Enabled

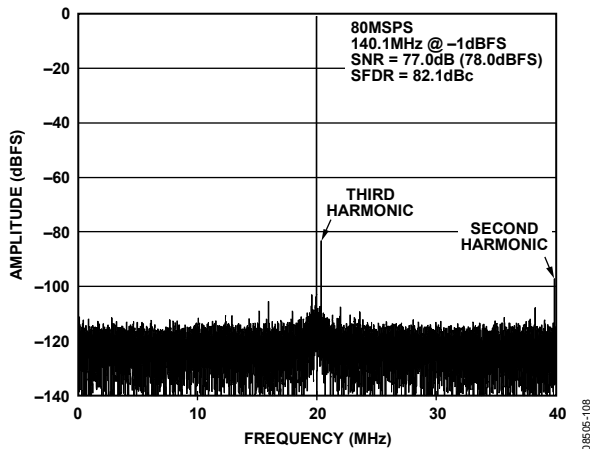

Figure 8. AD9255-80 Single-Tone FFT with $f_{IN} = 140.1$ MHz

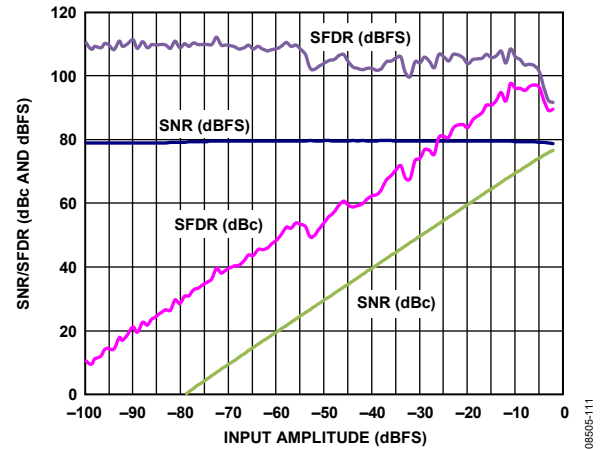

Figure 11. AD9255-80 Single-Tone SNR/SFDR vs. Input Amplitude (A_{IN}) with $f_{IN} = 98.12$ MHz

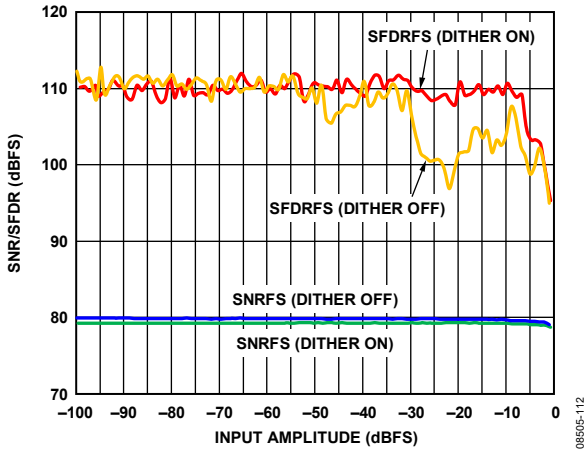

Figure 12. AD9255-80 Single-Tone SNR/SFDR vs. Input Amplitude (A_{IN}) with $f_{IN} = 30$ MHz with and without Dither Enabled

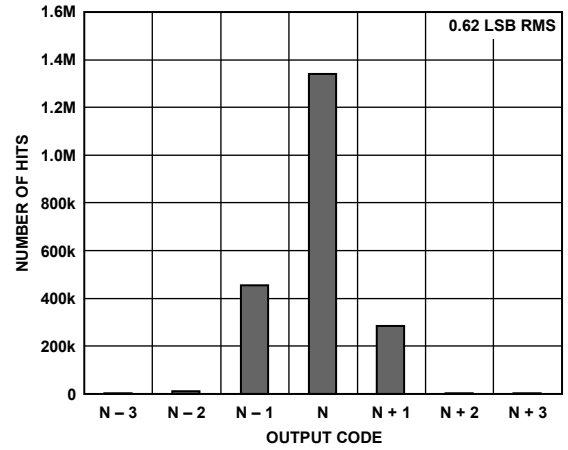

Figure 15. AD9255-80 Grounded Input Histogram

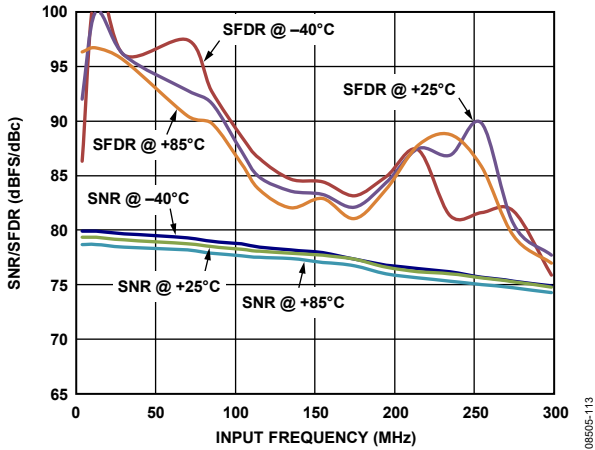

Figure 13. AD9255-80 Single-Tone SNR/SFDR vs. Input Frequency (f_{IN}) and Temperature with 2 V p-p Full Scale

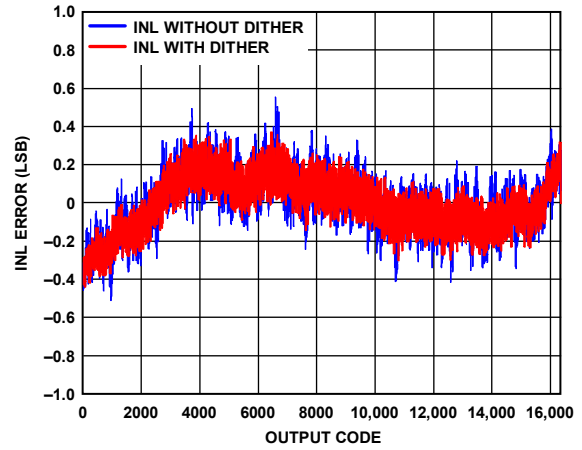

Figure 16. AD9255-80 INL with $f_{IN} = 12.5$ MHz

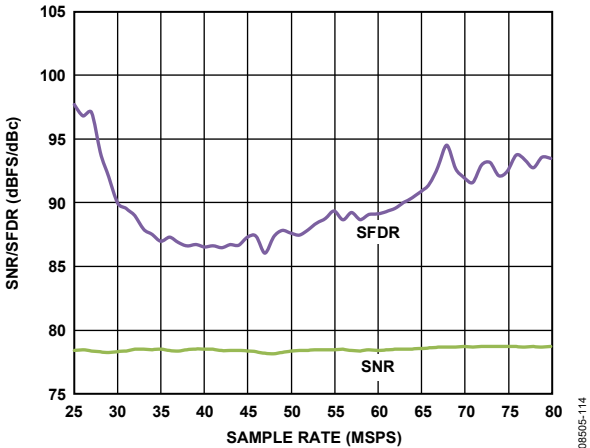

Figure 14. AD9255-80 Single-Tone SNR/SFDR vs. Sample Rate (f_s) with $f_{IN} = 70.1$ MHz

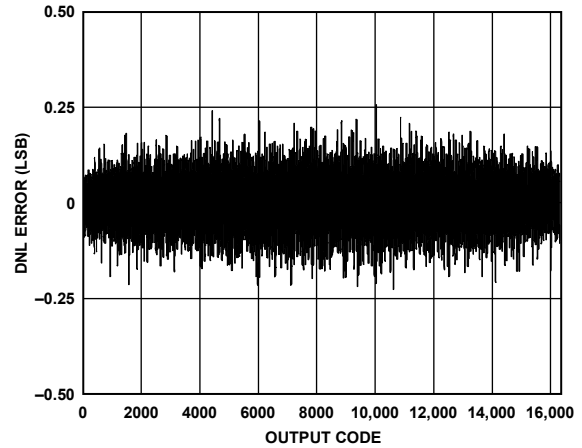

Figure 17. AD9255-80 DNL with $f_{IN} = 12.5$ MHz

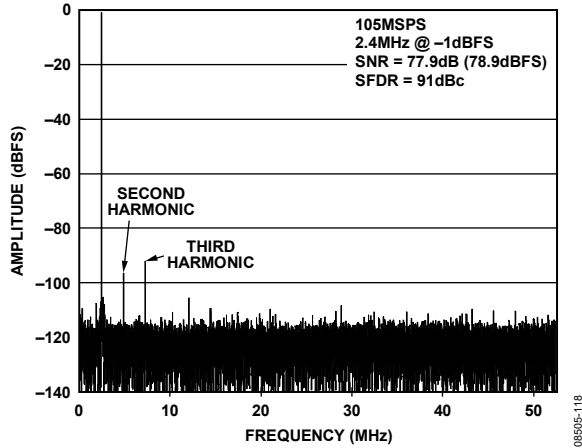

Figure 18. AD9255-105 Single-Tone FFT with $f_{IN} = 2.4$ MHz

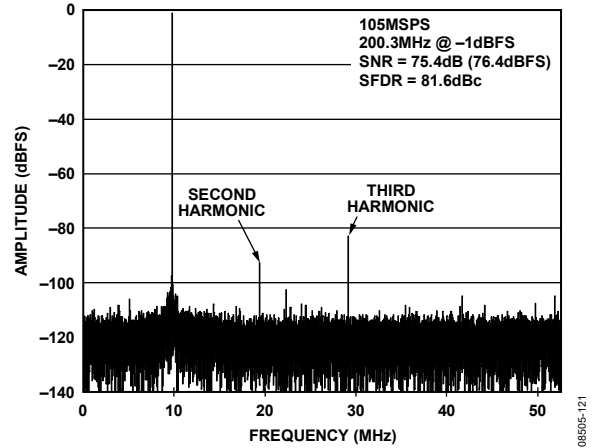

Figure 21. AD9255-105 Single-Tone FFT with $f_{IN} = 200.3$ MHz

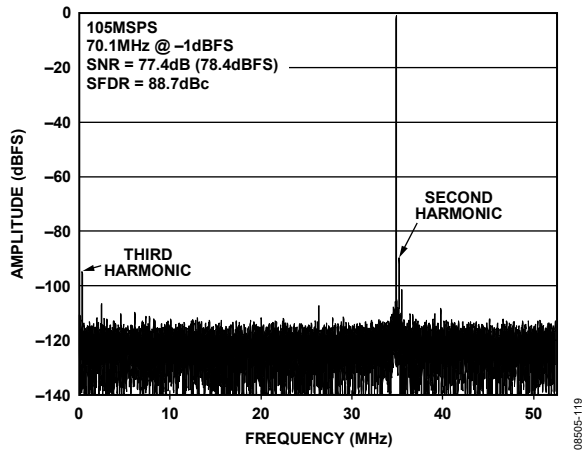

Figure 19. AD9255-105 Single-Tone FFT with $f_{IN} = 70.1$ MHz

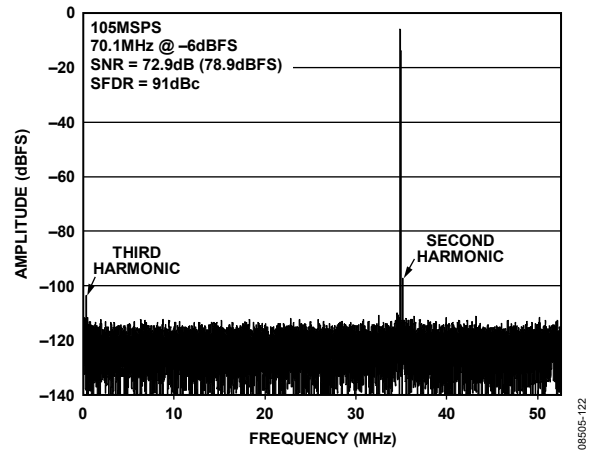

Figure 22. AD9255-105 Single-Tone FFT with $f_{IN} = 70.1$ MHz at -6 dBFS with Dither Enabled

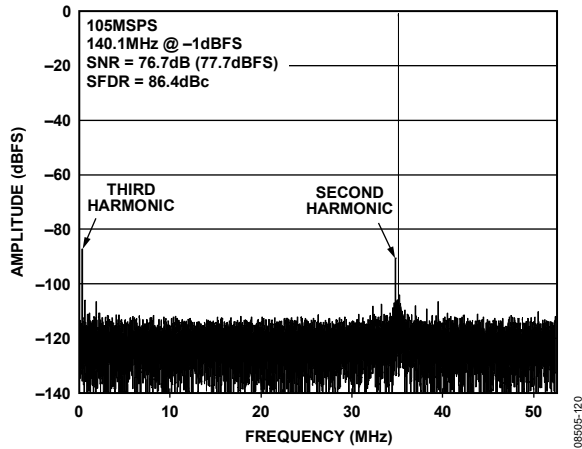

Figure 20. AD9255-105 Single-Tone FFT with $f_{IN} = 140.1$ MHz

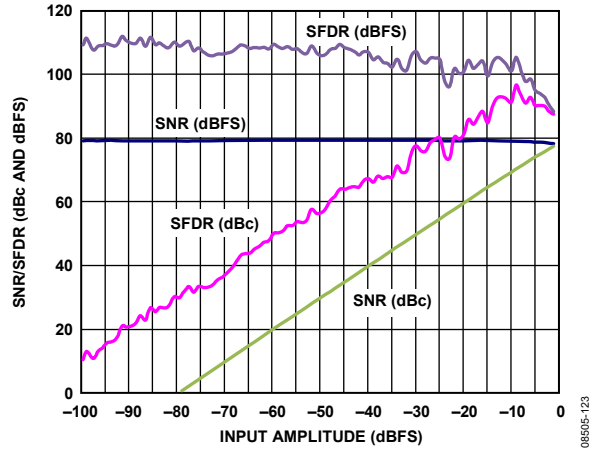

Figure 23. AD9255-105 Single-Tone SNR/SFDR vs. Input Amplitude (A_{IN}) with $f_{IN} = 98.12$ MHz

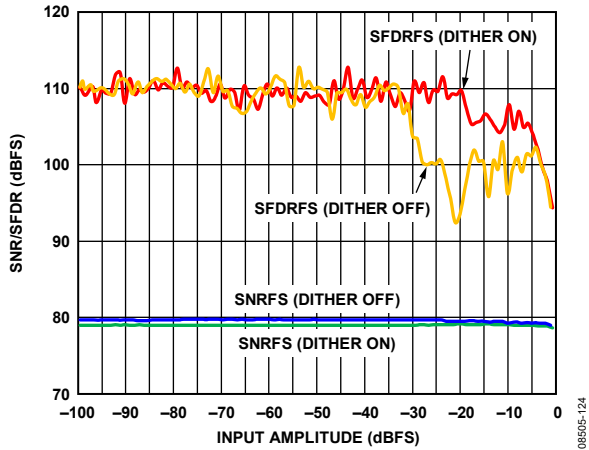

Figure 24. AD9255-105 Single-Tone SNR/SFDR vs. Input Amplitude (A_{IN}) with $f_{IN} = 30$ MHz with and without Dither Enabled

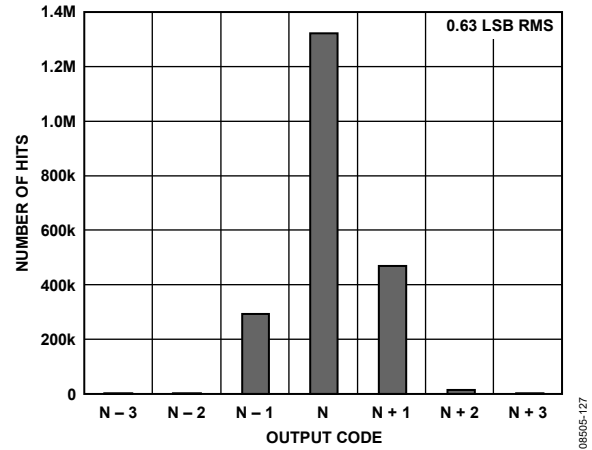

Figure 27. AD9255-105 Grounded Input Histogram

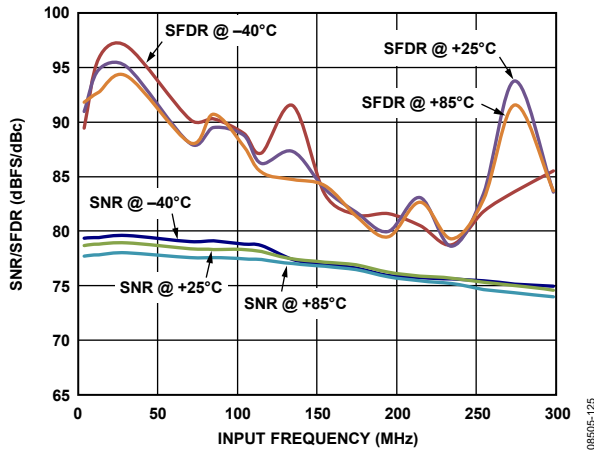

Figure 25. AD9255-105 Single-Tone SNR/SFDR vs. Input Frequency (f_{IN}) and Temperature with 2 V_{p-p} Full Scale

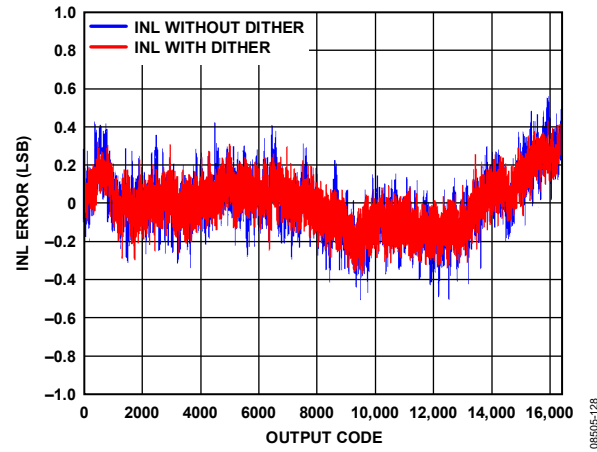

Figure 28. AD9255-105 INL with $f_{IN} = 12.5$ MHz

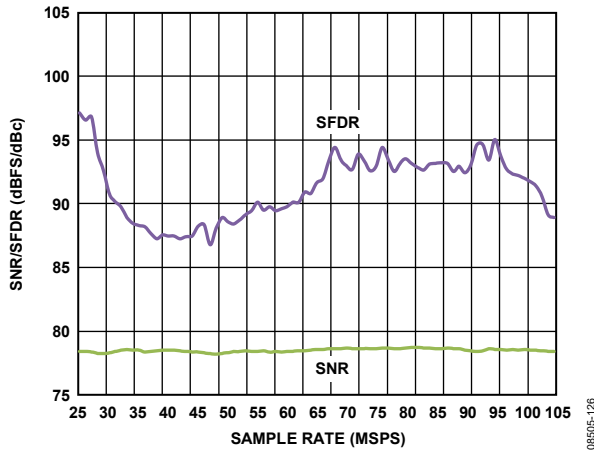

Figure 26. AD9255-105 Single-Tone SNR/SFDR vs. Sample Rate (f_s) with $f_{IN} = 70.1$ MHz

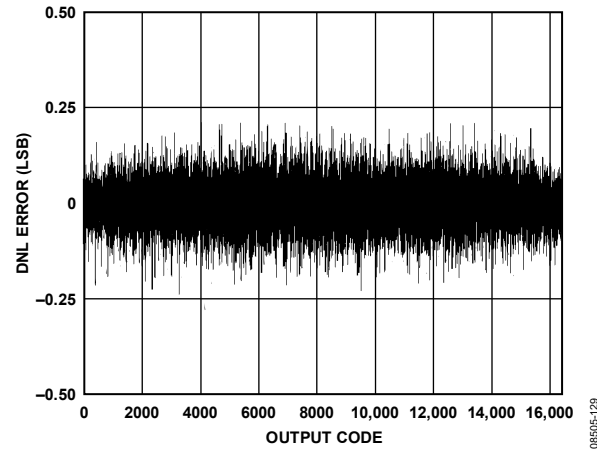

Figure 29. AD9255-105 DNL with $f_{IN} = 12.5$ MHz

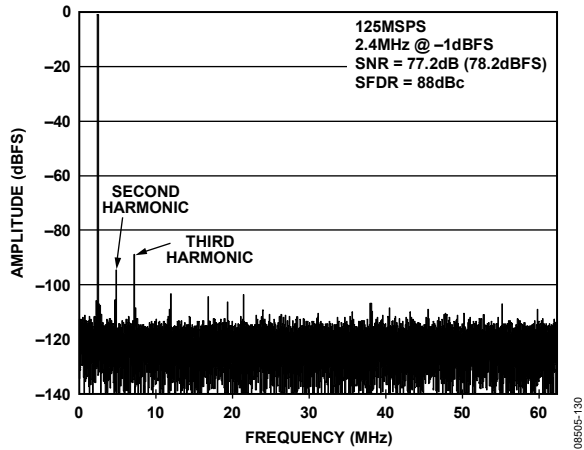

Figure 30. AD9255-125 Single-Tone FFT with $f_{IN} = 2.4$ MHz

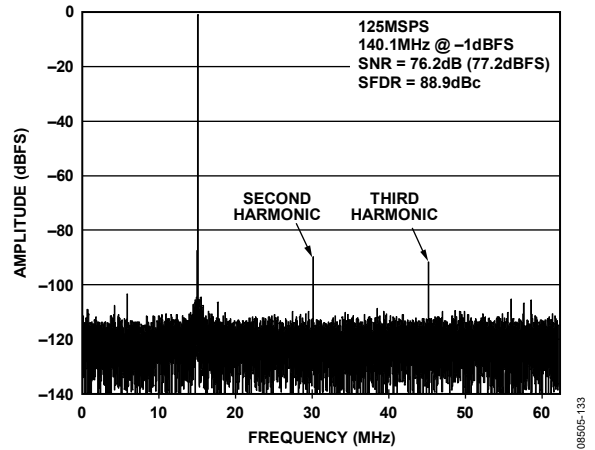

Figure 33. AD9255-125 Single-Tone FFT with $f_{IN} = 140.1$ MHz

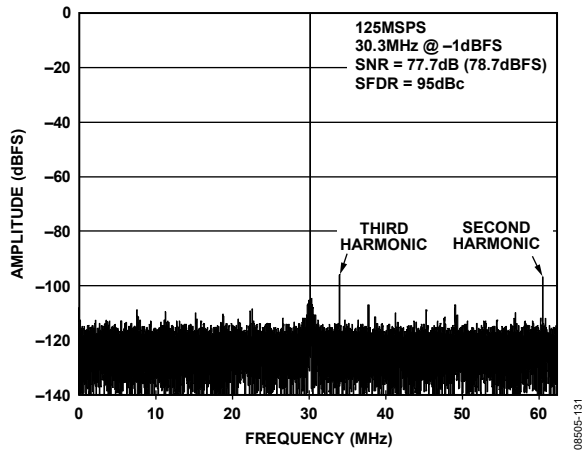

Figure 31. AD9255-125 Single-Tone FFT with $f_{IN} = 30.3$ MHz

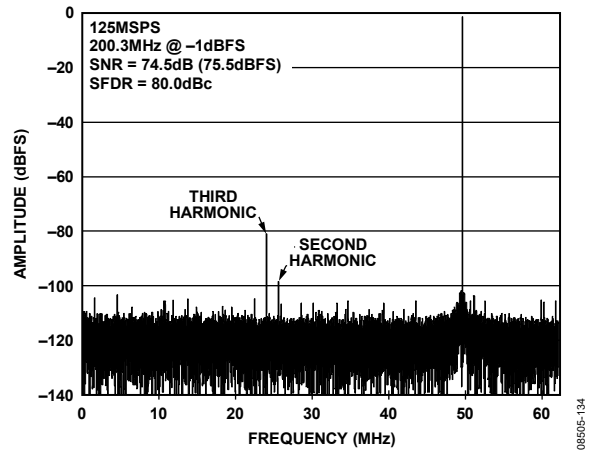

Figure 34. AD9255-125 Single-Tone FFT with $f_{IN} = 200.3$ MHz

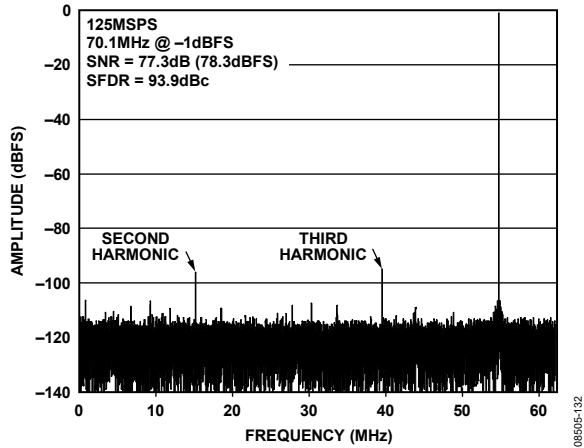

Figure 32. AD9255-125 Single-Tone FFT with $f_{IN} = 70.1$ MHz

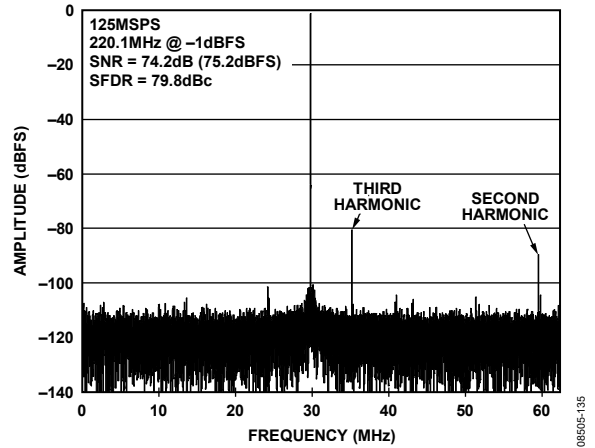

Figure 35. AD9255-125 Single-Tone FFT with $f_{IN} = 220.1$ MHz

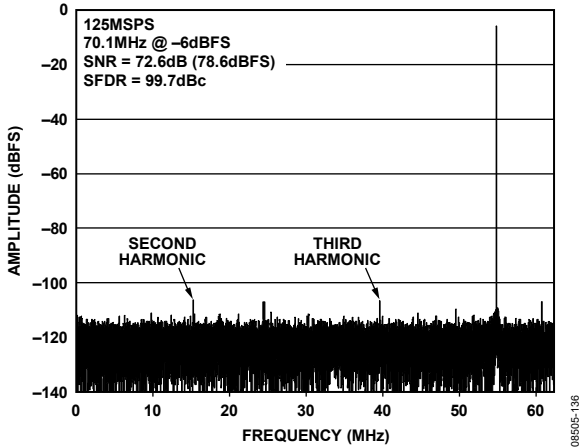

Figure 36. AD9255-125 Single-Tone FFT with $f_{IN} = 70.1$ MHz at -6 dBFS with Dither Enabled

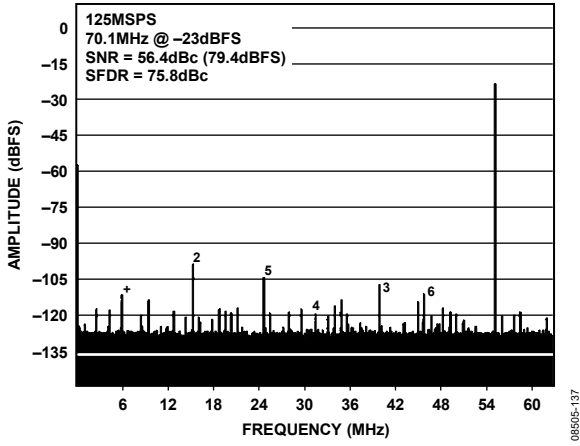

Figure 37. AD9255-125 Single-Tone FFT with $f_{IN} = 70.1$ MHz at -23 dBFS with Dither Disabled, 1M Sample

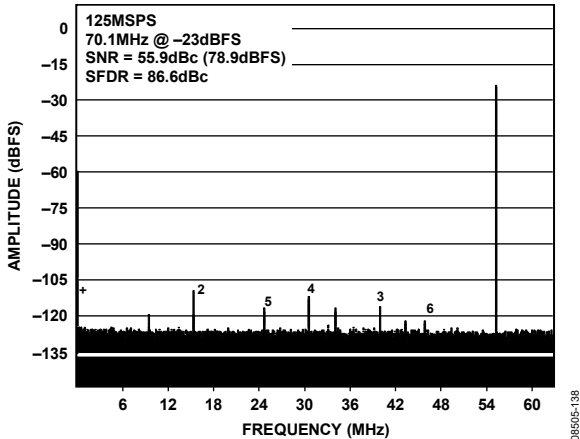

Figure 38. AD9255-125 Single-Tone FFT with $f_{IN} = 70.1$ MHz at -23 dBFS with Dither Enabled, 1M Sample

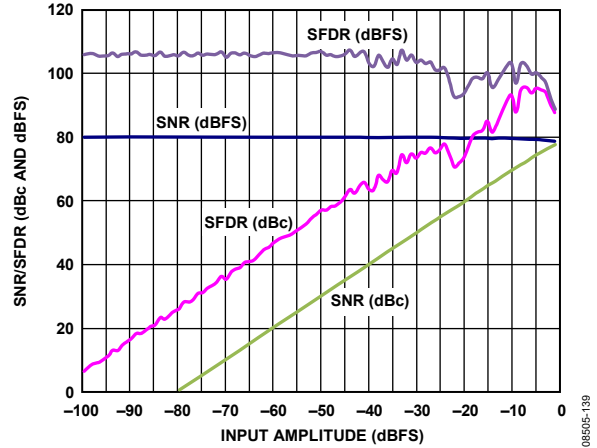

Figure 39. AD9255-125 Single-Tone SNR/SFDR vs. Input Amplitude (A_{IN}) with $f_{IN} = 2.4$ MHz

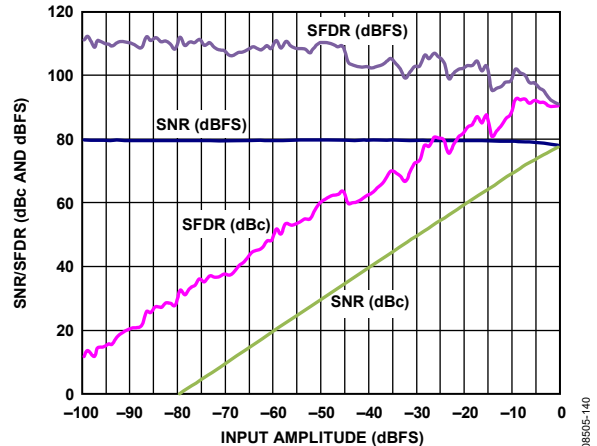

Figure 40. AD9255-125 Single-Tone SNR/SFDR vs. Input Amplitude (A_{IN}) with $f_{IN} = 98.12$ MHz

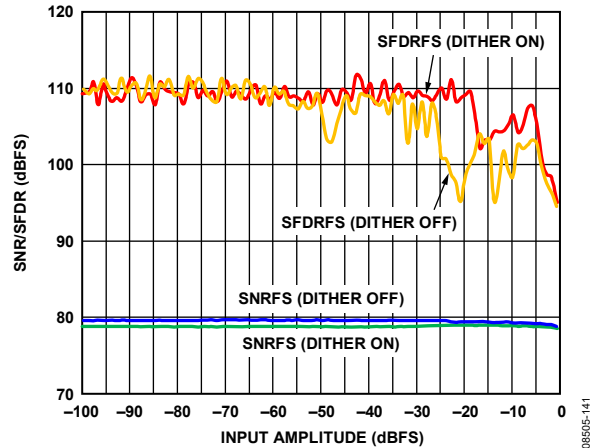

Figure 41. AD9255-125 Single-Tone SNR/SFDR vs. Input Amplitude (A_{IN}) with $f_{IN} = 30$ MHz With and Without Dither Enabled

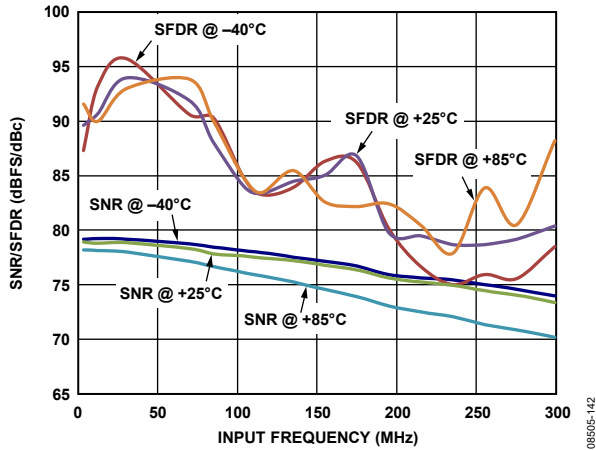

Figure 42. AD9255-125 Single-Tone SNR/SFDR vs. Input Frequency (f_{IN}) and Temperature with 2 V p-p Full Scale

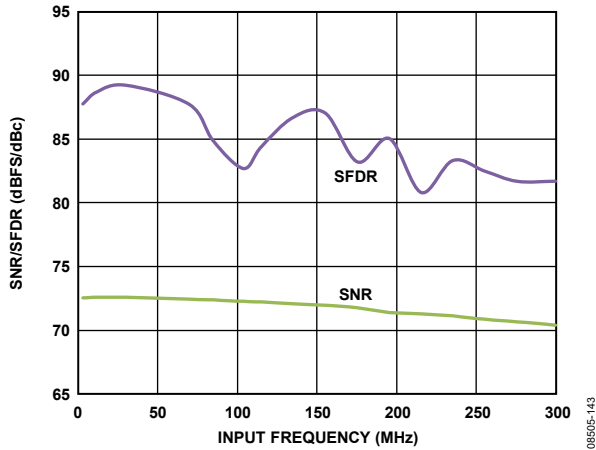

Figure 43. AD9255-125 Single-Tone SNR/SFDR vs. Input Frequency (f_{IN}) with 1 V p-p Full Scale

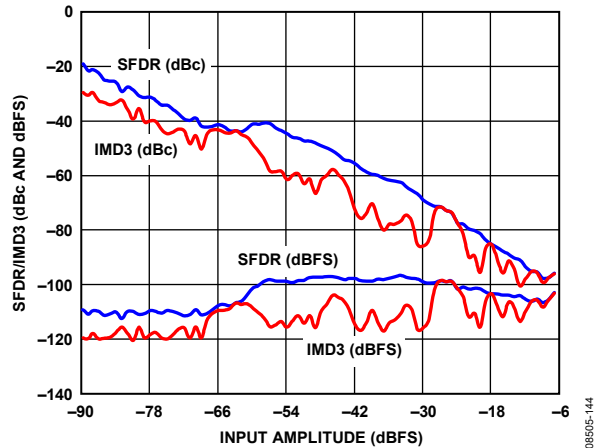

Figure 44. AD9255-125 Two-Tone SFDR/IMD3 vs. Input Amplitude (A_{IN}) with $f_{IN1} = 29.1$ MHz, $f_{IN2} = 32.1$ MHz, $f_S = 125$ MSPS

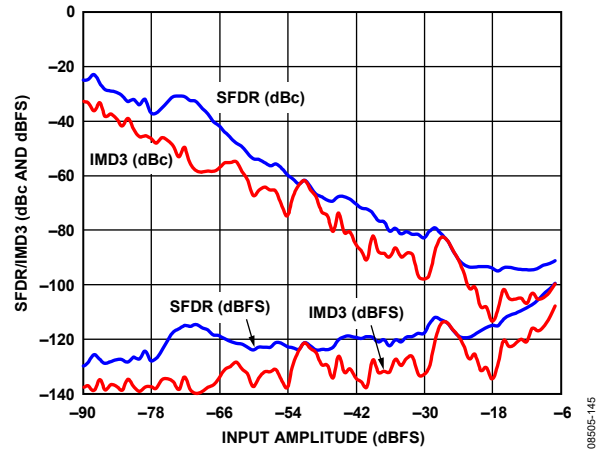

Figure 45. AD9255-125 Two-Tone SFDR/IMD3 vs. Input Amplitude (A_{IN}) with $f_{IN1} = 169.1$ MHz, $f_{IN2} = 172.1$ MHz, $f_S = 125$ MSPS

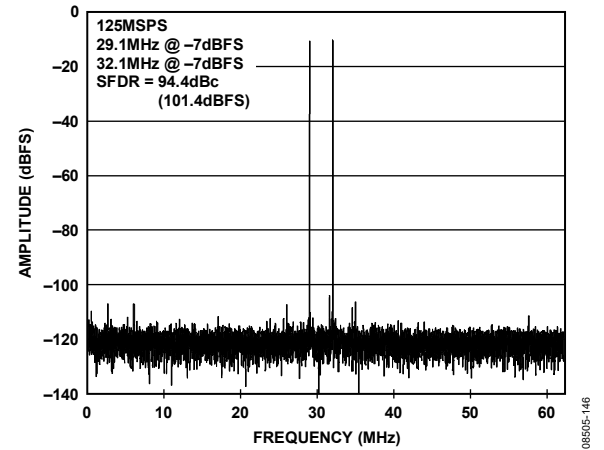

Figure 46. AD9255-125 Two-Tone FFT with $f_{IN1} = 29.1$ MHz and $f_{IN2} = 32.1$ MHz

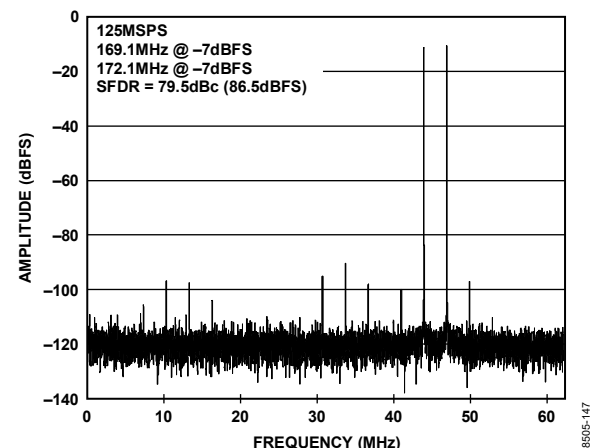

Figure 47. AD9255-125 Two-Tone FFT with $f_{IN1} = 169.1$ MHz and $f_{IN2} = 172.1$ MHz

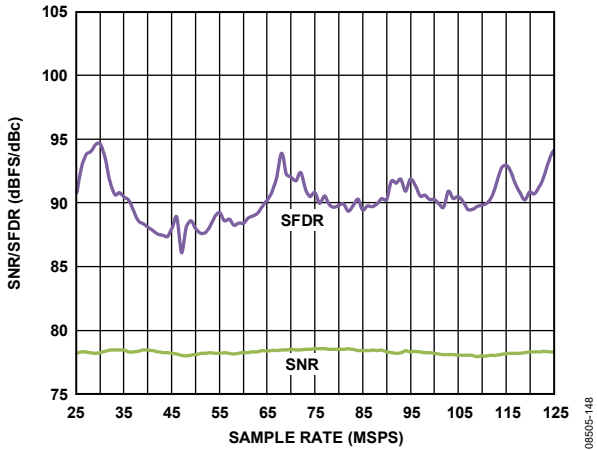

Figure 48. AD9255-125 Single-Tone SNR/SFDR vs. Sample Rate (f_s) with $f_{IN} = 70.1$ MHz

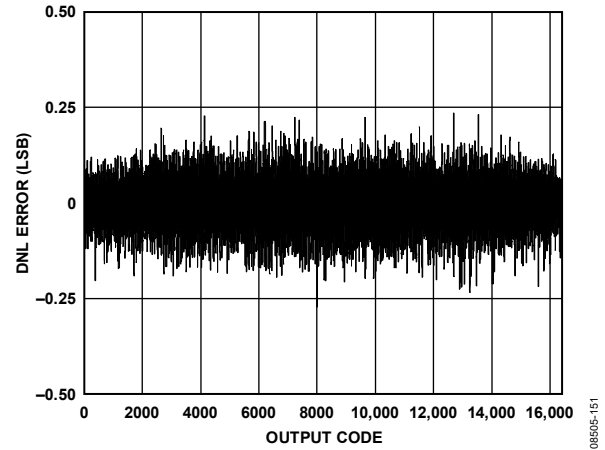

Figure 51. AD9255-125 DNL with $f_{IN} = 12.5$ MHz

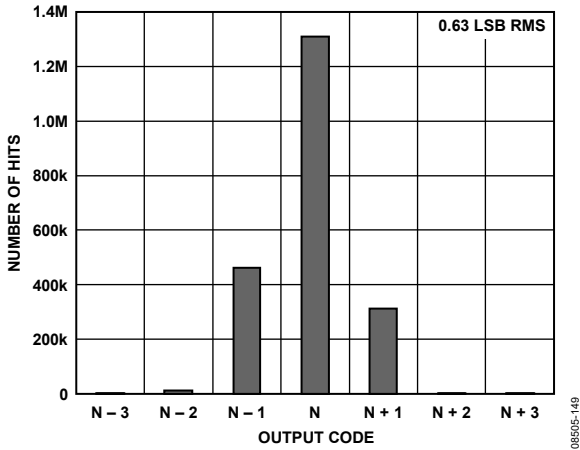

Figure 49. AD9255-125 Grounded Input Histogram

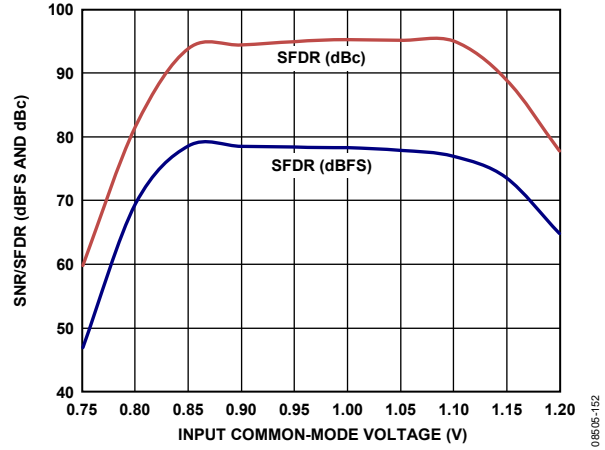

Figure 52. AD9255-125 SNR/SFDR vs. Input Common Mode (VCM) with $f_{IN} = 30$ MHz

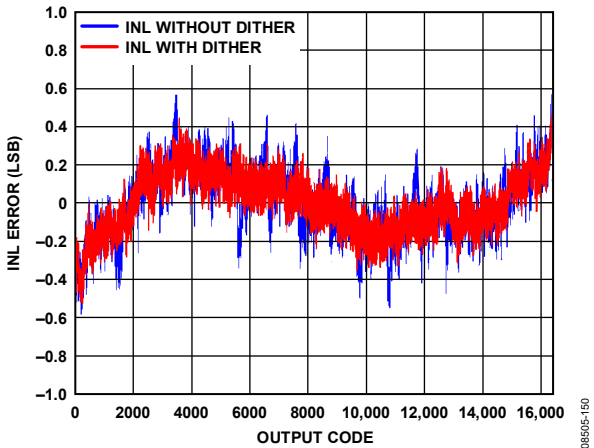

Figure 50. AD9255-125 INL with $f_{IN} = 12.5$ MHz

EQUIVALENT CIRCUITS

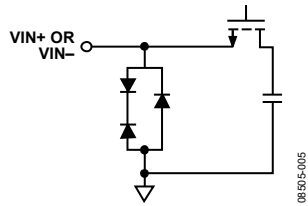

Figure 53. Equivalent Analog Input Circuit

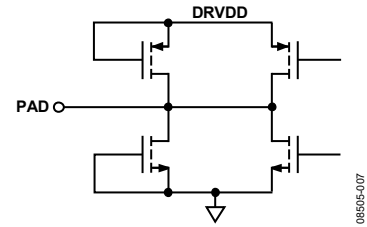

Figure 57. Digital Output

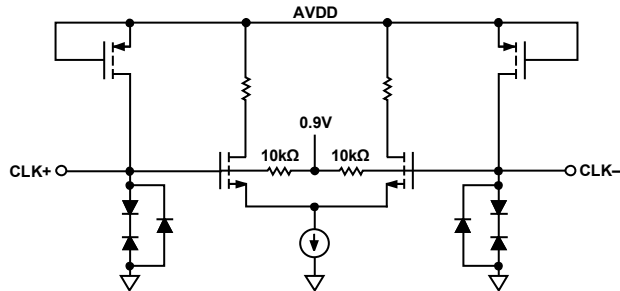

Figure 54. Equivalent Clock Input Circuit

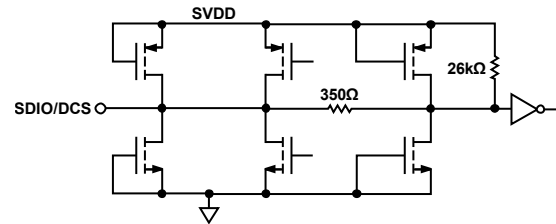

Figure 58. Equivalent SDIO/DCS Circuit

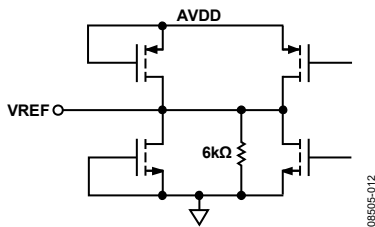

Figure 55. Equivalent VREF Circuit

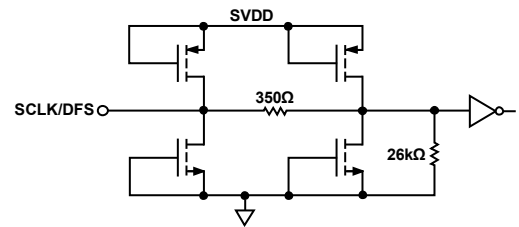

Figure 59. Equivalent SCLK/DFS Input Circuit

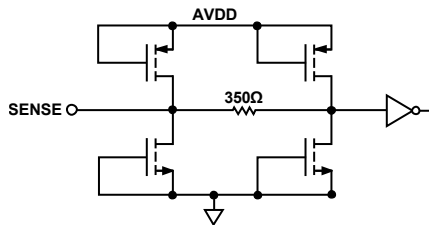

Figure 56. Equivalent SENSE Circuit

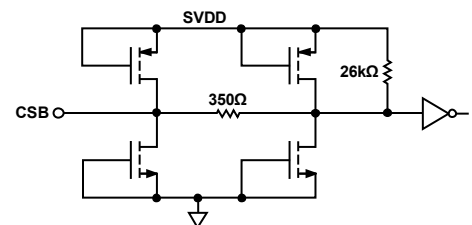

Figure 60. Equivalent CSB Input Circuit

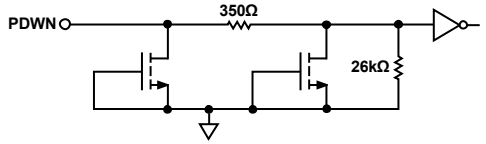

Figure 61. Equivalent PDWN Circuit

08505-061

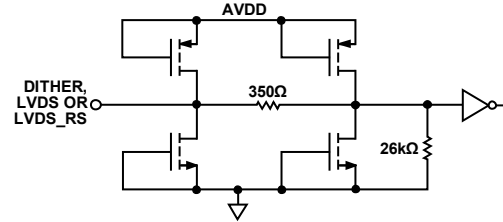

Figure 63. Equivalent DITHER, LVDS, and LVDS_RS Input Circuit

08505-063

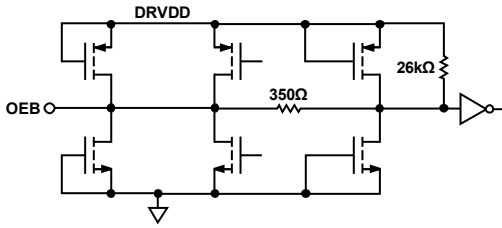

Figure 62. Equivalent OEB Input Circuit

08505-062

THEORY OF OPERATION

With the AD9255, the user can sample any $f_s/2$ frequency segment from dc to 200 MHz, using appropriate low-pass or band-pass filtering at the ADC inputs with little loss in ADC performance. Operation to 300 MHz analog input is permitted, but occurs at the expense of increased ADC noise and distortion.

Synchronization capability is provided to allow synchronized timing between multiple devices.

Programming and control of the AD9255 are accomplished using a 3-wire SPI-compatible serial interface.

ADC ARCHITECTURE

The AD9255 architecture consists of a front-end sample-and-hold input network, followed by a pipelined, switched-capacitor ADC. The quantized outputs from each stage are combined into a final 14-bit result in the digital correction logic. The pipelined architecture permits the first stage to operate on a new input sample and the remaining stages to operate on the preceding samples. Sampling occurs on the rising edge of the clock.

Each stage of the pipeline, excluding the last, consists of a low resolution flash ADC connected to a switched-capacitor digital-to-analog converter (DAC) and an interstage residue amplifier. The residue amplifier magnifies the difference between the reconstructed DAC output and the flash input for the next stage in the pipeline. One bit of redundancy is used in each stage to facilitate digital correction of flash errors. The last stage simply consists of a flash ADC.

The input stage can be ac- or dc-coupled in differential or single-ended modes. The output staging block aligns the data, corrects errors, and passes the data to the output buffers. The output buffers are powered from a separate supply, allowing adjustment of the output voltage swing. During power-down, the output buffers go into a high impedance state.

ANALOG INPUT CONSIDERATIONS

The analog input to the AD9255 is a differential switched-capacitor network that has been designed for optimum performance while processing a differential input signal.

The clock signal alternatively switches between sample mode and hold mode (see Figure 64). When the input is switched into sample mode, the signal source must be capable of charging the sample capacitors and settling within 1/2 of a clock cycle.

A small resistor in series with each input can help reduce the peak transient current required from the output stage of the driving source. A shunt capacitor can be placed across the inputs to provide dynamic charging currents. This passive network creates a low-pass filter at the ADC input; therefore, the precise values are dependent on the application.

In intermediate frequency (IF) undersampling applications, any shunt capacitors should be reduced. In combination with the driving source impedance, the shunt capacitors limit the input bandwidth. Refer to AN-742 Application Note, *Frequency Domain Response of Switched-Capacitor ADCs*; AN-827 Application Note, *A Resonant Approach to Interfacing Amplifiers to Switched-Capacitor ADCs*; and the *Analog Dialogue* article, “Transformer-Coupled Front-End for Wideband A/D Converters,” for more information on this subject (see www.analog.com).

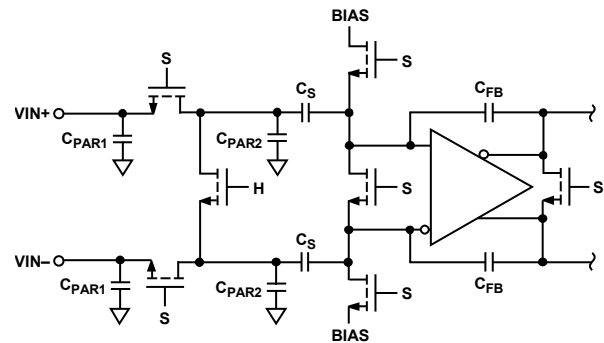

Figure 64. Switched-Capacitor Input

For best dynamic performance, the source impedances driving V_{IN+} and V_{IN-} should be matched, and the inputs should be differentially balanced.

An internal differential reference buffer creates positive and negative reference voltages that define the input span of the ADC core. The span of the ADC core is set by this buffer to $2 \times V_{REF}$.

Input Common Mode

The analog inputs of the AD9255 are not internally dc biased. In ac-coupled applications, the user must provide this bias externally. Setting the device so that $V_{CM} = 0.5 \times AV_{DD}$ is recommended for optimum performance, but the device functions over a wider range with reasonable performance (see Figure 52). An on-board common-mode voltage reference is included in the design and is available from the VCM pin. Optimum performance is achieved when the common-mode voltage of the analog input is set by the VCM pin voltage (typically $0.5 \times AV_{DD}$). The VCM pin must be decoupled to ground by a 0.1 μF capacitor, as described in the Applications Information section.

Dither

The AD9255 has an optional dither mode that can be selected either using the DITHER pin or using the SPI bus. Dithering is the act of injecting a known but random amount of white noise, commonly referred to as dither, into the input of the ADC. Dithering has the effect of improving the local linearity at various points along the ADC transfer function. Dithering can significantly improve the SFDR when quantizing small signal inputs, typically when the input level is below -6 dBFS.

As shown in Figure 65, the dither that is added to the input of the ADC through the dither DAC is precisely subtracted out digitally to minimize SNR degradation. When dithering is enabled, the dither DAC is driven by a pseudorandom number generator (PN gen). In the AD9255, the dither DAC is precisely calibrated to result in only a very small degradation in SNR and SINAD. The typical SNR and SINAD degradation values, with dithering enabled, are only 1 dB and 0.8 dB, respectively.

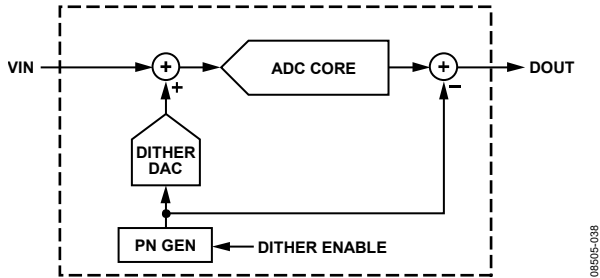

Figure 65. Dither Block Diagram

Large Signal FFT

In most cases, dithering does not improve SFDR for large signal inputs close to full scale, for example, with a -1 dBFS input. For large signal inputs, the SFDR is typically limited by front-end sampling distortion, which dithering cannot improve. However, even for such large signal inputs, dithering may be useful for certain applications because it makes the noise floor whiter. As is common in pipeline ADCs, the AD9255 contains small DNL errors caused by random component mismatches that produce spurs or tones that make the noise floor somewhat randomly colored part-to-part. Although these tones are typically at very low levels and do not limit SFDR when the ADC is quantizing large-signal inputs, dithering converts these tones to noise and produces a whiter noise floor.

Small Signal FFT

For small signal inputs, the front-end sampling circuit typically contributes very little distortion, and, therefore, the SFDR is likely to be limited by tones caused by DNL errors due to random component mismatches. Therefore, for small signal inputs (typically, those below -6 dBFS), dithering can significantly improve SFDR by converting these DNL tones to white noise.

Static Linearity

Dithering also removes sharp local discontinuities in the INL transfer function of the ADC and reduces the overall peak-to-peak INL.

In receiver applications, utilizing dither helps to reduce DNL errors that cause small signal gain errors. Often, this issue is overcome by setting the input noise at 5 dB to 10 dB above the converter noise. By utilizing dither within the converter to correct the DNL errors, the input noise requirement can be reduced.

Differential Input Configurations

Optimum performance is achieved while driving the AD9255 in a differential input configuration. For baseband applications, the AD8138, ADA4937-2, and ADA4938-2 differential drivers provide excellent performance and a flexible interface to the ADC.

The output common-mode voltage of the ADA4938-2 is easily set with the VCM pin of the AD9255 (see Figure 66), and the driver can be configured in the filter topology shown to provide band limiting of the input signal.

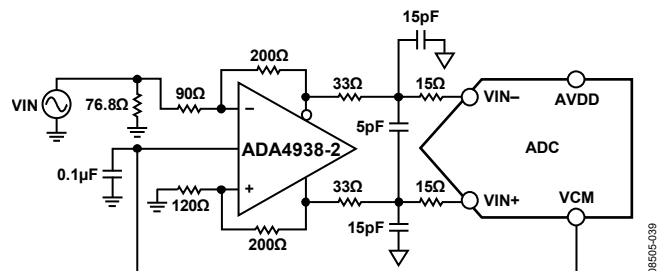

Figure 66. Differential Input Configuration Using the ADA4938-2

For baseband applications where SNR is a key parameter, differential transformer coupling is the recommended input configuration. An example is shown in Figure 67. To bias the analog input, the VCM voltage can be connected to the center tap of the secondary winding of the transformer.

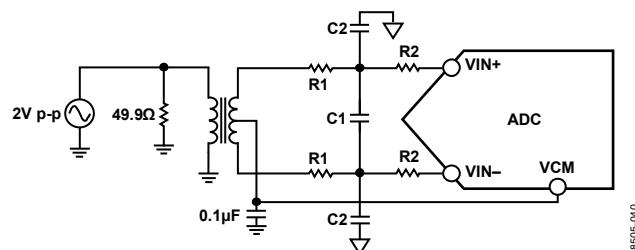

Figure 67. Differential Transformer-Coupled Configuration

The signal characteristics must be considered when selecting a transformer. Most RF transformers saturate at frequencies below a few megahertz (MHz). Excessive signal power can also cause core saturation, which leads to distortion.

At input frequencies in the second Nyquist zone and above, the noise performance of most amplifiers is not adequate to achieve the true SNR performance of the AD9255. For applications in

which SNR is a key parameter, differential double balun coupling is the recommended input configuration (see Figure 68). In this configuration, the input is ac-coupled and the CML is provided to each input through a 33 Ω resistor. These resistors compensate for losses in the input baluns to provide a 50 Ω impedance to the driver.

In the double balun and transformer configurations, the value of the input capacitors and resistors is dependent on the input frequency and source impedance and may need to be reduced or removed. Table 10 displays recommended values to set the RC network. However, these values are dependent on the input signal and should be used only as a starting guide.

Table 10. Example RC Network

Frequency Range (MHz)	R1 Series (Ω Each)	C1 Differential (pF)	R2 Series (Ω Each)	C2 Shunt (pF Each)
0 to 100	15	18	15	Open
100 to 300	10	10	10	10

An alternative to using a transformer-coupled input at frequencies in the second Nyquist zone and higher is to use the ADL5562 differential driver. The ADL5562 provides three selectable gain options up to 15.5 dB. An example circuit is shown in Figure 69; additional filtering between the ADL5562 output and the AD9255 input may be required to reduce out-of-band noise. See the [ADL5562](#) data sheet for more information.

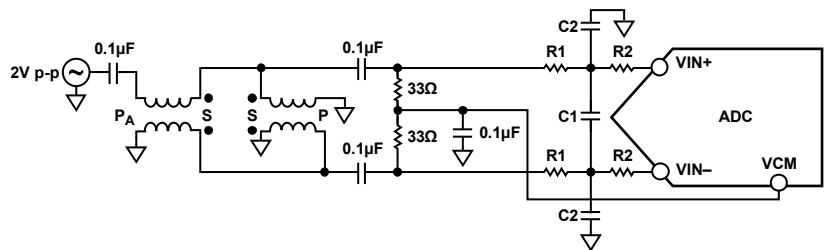

Figure 68. Differential Double Balun Input Configuration

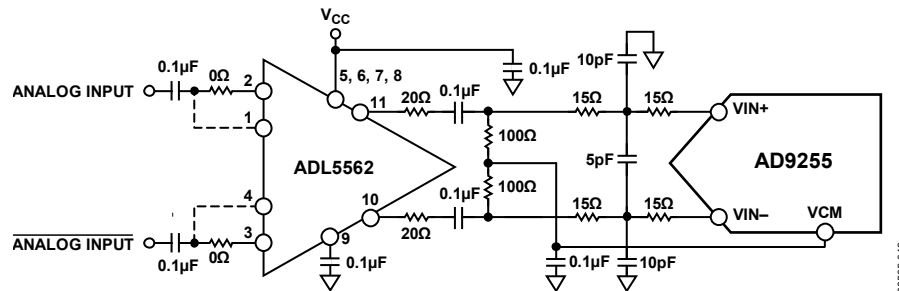

Figure 69. Differential Input Configuration Using the ADL5562

VOLTAGE REFERENCE

A stable and accurate voltage reference is built into the AD9255. The input range can be adjusted by varying the reference voltage applied to the AD9255, using either the internal reference or an externally applied reference voltage. The input span of the ADC tracks reference voltage changes linearly. The various reference modes are summarized in the sections that follow. The Reference Decoupling section describes the best practices PCB layout of the reference.

Internal Reference Connection

A comparator within the AD9255 detects the potential at the SENSE pin and configures the reference into four possible modes, which are summarized in Table 11. If SENSE is grounded, the reference amplifier switch is connected to the internal resistor divider (see Figure 70), setting VREF to 1.0 V for a 2.0 V p-p full-scale input. In this mode, with SENSE grounded, the full scale can also be adjusted through the SPI port by adjusting Bit 6 and Bit 7 of Register 0x18. These bits can be used to change the full scale to 1.25 V p-p, 1.5 V p-p, 1.75 V p-p, or to the default of 2.0 V p-p, as shown in Table 17.

Connecting the SENSE pin to the VREF pin switches the reference amplifier output to the SENSE pin, completing the loop and providing a 0.5 V reference output for a 1 V p-p full-scale input.

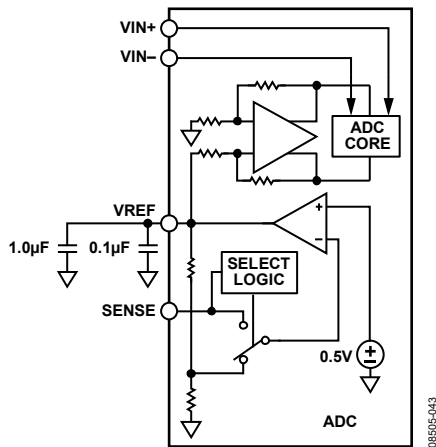

Figure 70. Internal Reference Configuration

If a resistor divider is connected external to the chip, as shown in Figure 71, the switch again sets to the SENSE pin. This puts

the reference amplifier in a noninverting mode with the VREF output defined as follows:

$$V_{REF} = 0.5 \times \left(1 + \frac{R2}{R1} \right)$$

The input range of the ADC always equals twice the voltage at the reference pin for either an internal or an external reference.

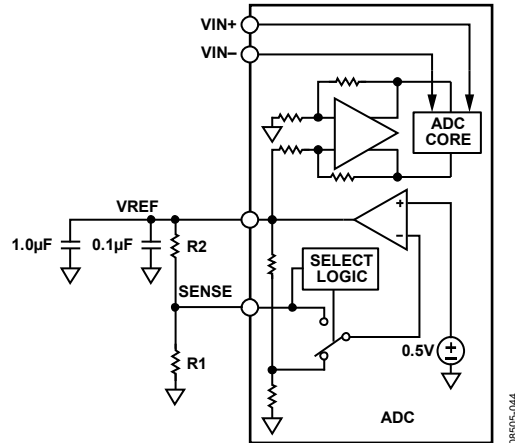

Figure 71. Programmable Reference Configuration

If the internal reference of the AD9255 is used to drive multiple converters to improve gain matching, the loading of the reference by the other converters must be considered. Figure 72 shows how the internal reference voltage is affected by loading.

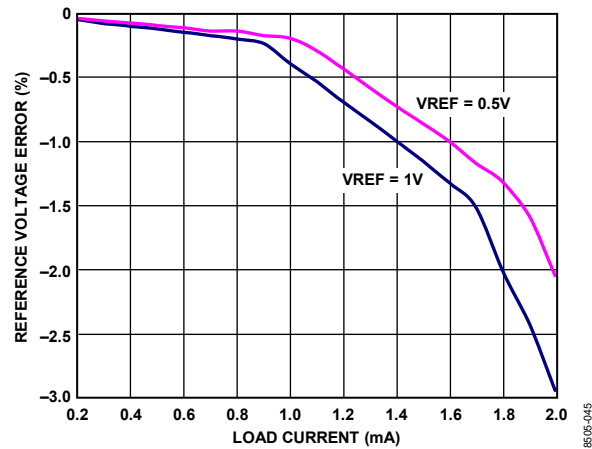

Figure 72. VREF Accuracy vs. Load

Table 11. Reference Configuration Summary

Selected Mode	SENSE Voltage	Resulting VREF (V)	Resulting Differential Span (V p-p)
External Reference	AVDD	N/A	2 × external reference
Internal Fixed Reference	VREF	0.5	1.0
Programmable Reference	0.2 V to VREF	$0.5 \times \left(1 + \frac{R2}{R1} \right)$ (see Figure 71)	2 × VREF
Internal Fixed Reference	AGND to 0.2 V	1.0	2.0

External Reference Operation

The use of an external reference may be necessary to enhance the gain accuracy of the ADC or improve thermal drift characteristics. Figure 73 shows the typical drift characteristics of the internal reference in 1.0 V mode.

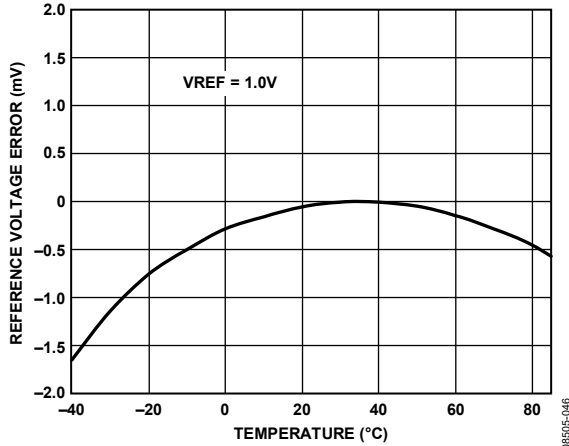

Figure 73. Typical VREF Drift

When the SENSE pin is tied to AVDD, the internal reference is disabled, allowing the use of an external reference. An internal reference buffer loads the external reference with an equivalent 6 kΩ load (see Figure 55). The internal buffer generates the positive and negative full-scale references for the ADC core. Therefore, the external reference must be limited to a maximum of 1.0 V.

CLOCK INPUT CONSIDERATIONS

For optimum performance, the AD9255 sample clock inputs, CLK+ and CLK-, should be clocked with a differential signal. The signal is typically ac-coupled into the CLK+ and CLK- pins via a transformer or capacitors. These pins are biased internally (see Figure 74) and require no external bias.

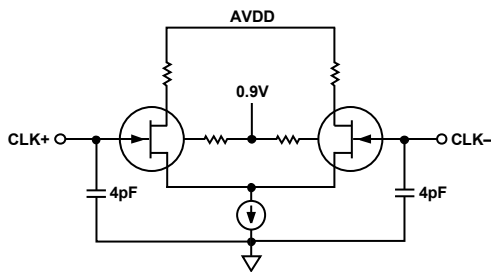

Figure 74. Equivalent Clock Input Circuit

Clock Input Options

The AD9255 has a very flexible clock input structure. Clock input can be a CMOS, LVDS, LVPECL, or sine wave signal. Regardless of the type of signal being used, clock source jitter is of the most concern, as described in the Jitter Considerations section.

Figure 75 and Figure 76 show two preferred methods for clocking the AD9255. A low jitter clock source is converted from a single-ended signal to a differential signal using either an RF transformer or an RF balun.

The RF balun configuration is recommended for clock frequencies at 625 MHz and the RF transformer is recommended for clock frequencies from 10 MHz to 200 MHz. The back-to-back Schottky diodes across the transformer/balun secondary limit clock excursions into the AD9255 to approximately 0.8 V p-p differential.

This limit helps prevent the large voltage swings of the clock from feeding through to other portions of the AD9255 while preserving the fast rise and fall times of the signal that are critical to low jitter performance.

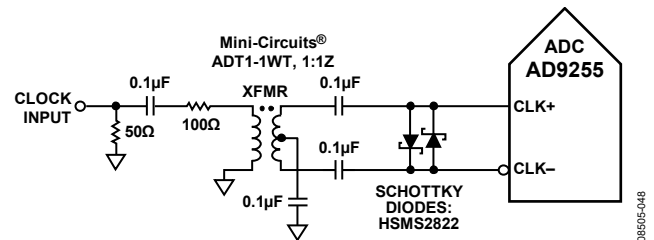

Figure 75. Transformer-Coupled Differential Clock (Up to 200 MHz)

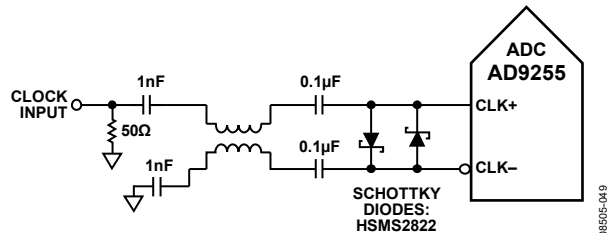

Figure 76. Balun-Coupled Differential Clock (625 MHz)

If a low jitter clock source is not available, another option is to ac couple a differential PECL signal to the sample clock input pins, as shown in Figure 77. The [AD9510/AD9511/AD9512/AD9513/AD9514/AD9515/AD9516/AD9517/AD9518/AD9520/AD9522](#) clock drivers offer excellent jitter performance.

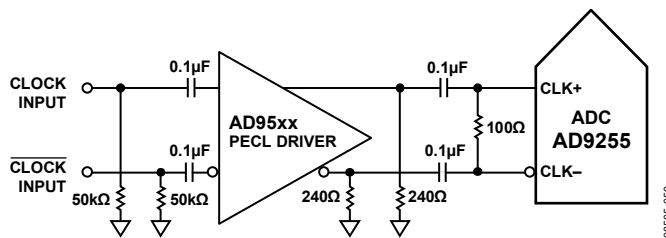

Figure 77. Differential PECL Sample Clock (Up to Rated Sample Rate)

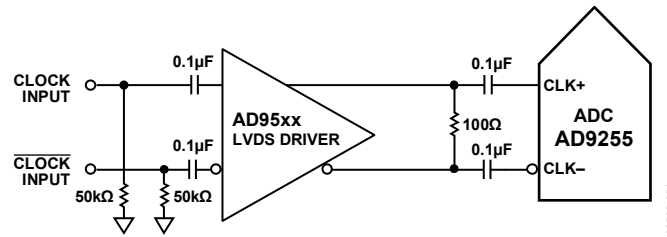
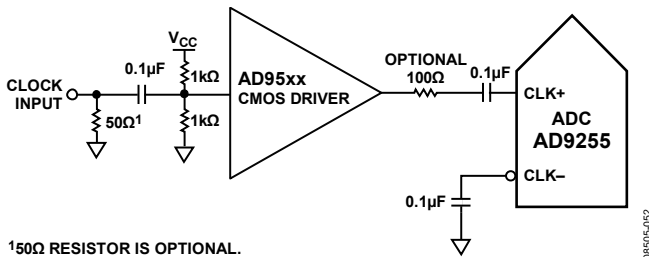

Figure 78. Differential LVDS Sample Clock (Up to the Rated Sample Rate)

A third option is to ac couple a differential LVDS signal to the sample clock input pins, as shown in Figure 78. The AD9510/AD9511/AD9512/AD9513/AD9514/AD9515/AD9516/AD9517/AD9518/AD9520/AD9522 clock drivers offer excellent jitter performance.

In some applications, it may be acceptable to drive the sample clock inputs with a single-ended CMOS signal. In such applications, drive the CLK+ pin directly from a CMOS gate, and bypass the CLK- pin to ground with a 0.1 µF capacitor (see Figure 79).



150Ω RESISTOR IS OPTIONAL.

Figure 79. Single-Ended 1.8 V CMOS Input Clock (Up to 200 MHz)

Clock Duty Cycle

Typical high speed ADCs use both clock edges to generate a variety of internal timing signals and, as a result, may be sensitive to clock duty cycle. Commonly, a $\pm 5\%$ tolerance is required on the clock duty cycle to maintain dynamic performance characteristics.

The AD9255 contains a duty cycle stabilizer (DCS) that retimes the nonsampling (falling) edge, providing an internal clock signal with a nominal 50% duty cycle. This allows the user to provide a wide range of clock input duty cycles without affecting the performance of the AD9255. Noise and distortion performance are nearly flat for a wide range of duty cycles with the DCS enabled. Jitter in the rising edge of the input is still of paramount concern and is not easily reduced by the internal stabilization circuit.

The duty cycle control loop does not function for clock rates less than 20 MHz nominally. The loop has a time constant associated with it that must be considered in applications in which the clock rate can change dynamically. A wait time of 1.5 µs to 5 µs is required after a dynamic clock frequency increase or decrease before the DCS loop is relocked to the input signal. During the time period that the loop is not locked, the DCS loop is bypassed, and the internal device timing is dependent on the duty cycle of the input clock signal. In such applications, it may be appropriate to disable the duty cycle stabilizer. The

DCS can also be disabled in some cases when using the input clock divider circuit, see the Input Clock Divider section for additional information. In all other applications, enabling the DCS circuit is recommended to maximize ac performance.

The DCS is enabled by setting the SDIO/DCS pin high when operating in the external pin mode (see Table 12). If the SPI mode is enabled, the DCS is enabled by default and can be disabled by writing a 0x00 to Address 0x09.

Input Clock Divider

The AD9255 contains an input clock divider with the ability to divide the input clock by integer values between 2 and 8. For clock divide ratios of 2, 4, 6, or 8, the duty cycle stabilizer (DCS) is not required because the output of the divider inherently produces a 50% duty cycle. Enabling the DCS with the clock divider in these divide modes may cause a slight degradation in SNR so disabling the DCS is recommended. For other divide ratios, divide-by-3, divide-by-5, and divide-by-7 the duty cycle output from the clock divider is related to the input clock's duty cycle. In these modes, if the input clock has a 50% duty cycle, the DCS is again not required. However, if a 50% duty cycle input clock is not available the DCS must be enabled for proper part operation.

To synchronize the AD9255 clock divider, use an external sync signal applied to the SYNC pin. Bit 1 and Bit 2 of Register 0x100 allow the clock divider to be resynchronized on every SYNC signal or only on the first SYNC signal after the register is written. A valid signal at the SYNC pin causes the clock divider to reset to its initial state. This synchronization feature allows multiple parts to have their clock dividers aligned to guarantee simultaneous input sampling. If the SYNC pin is not used, it should be tied to AGND.

Jitter Considerations

High speed, high resolution ADCs are sensitive to the quality of the clock input. The degradation in SNR from the low frequency SNR (SNR_{LF}) at a given input frequency (f_{INPUT}) due to jitter (t_{JMS}) can be calculated by

$$SNR_{HF} = -10 \log[(2\pi \times f_{INPUT} \times t_{JMS})^2 + 10^{(-SNR_{LF}/10)}]$$

In this equation, the rms aperture jitter represents the clock input jitter specification. IF undersampling applications are particularly sensitive to jitter, as illustrated in Figure 80.

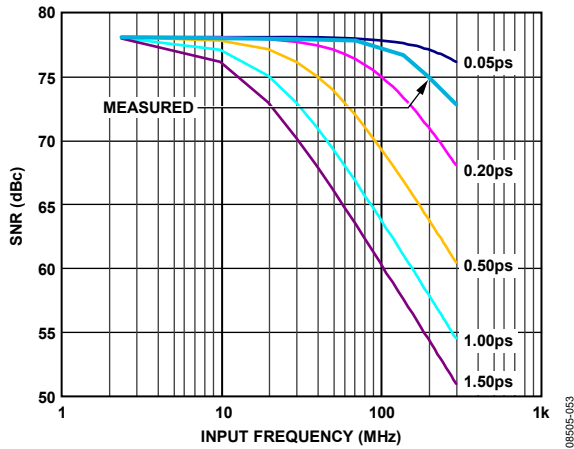

Figure 80. SNR vs. Input Frequency and Jitter

Treat the clock input as an analog signal in cases in which aperture jitter may affect the dynamic range of the AD9255. To avoid modulating the clock signal with digital noise, separate power supplies for clock drivers from the ADC output driver supplies. Low jitter, crystal controlled oscillators make the best clock sources. If the clock is generated from another type of source (by gating, dividing, or another method), the output clock should be retimed by the original clock at the last step.

Refer to AN-501 Application Note, *Aperture Uncertainty and ADC System Performance*, and AN-756 Application Note, *Sampled Systems and the Effects of Clock Phase Noise and Jitter* (see www.analog.com) for more information about jitter performance as it relates to ADCs.

POWER DISSIPATION AND STANDBY MODE

As shown in Figure 81, the power dissipated by the AD9255 is proportional to its sample rate. In CMOS output mode, the digital power dissipation is determined primarily by the strength of the digital drivers and the load on each output bit.

The maximum DRVDD current (IDRVDD) can be approximately calculated as

$$IDRVDD = VDRVDD \times C_{LOAD} \times f_{CLK} \times N$$

where *N* is the number of output bits (14 output bits plus one DCO).

This maximum current occurs when every output bit switches on every clock cycle, that is, a full-scale square wave at the Nyquist frequency of $f_{CLK}/2$. In practice, the DRVDD current is established by the average number of output bits switching, which is determined by the sample rate and the characteristics of the analog input signal.

Reducing the capacitive load presented to the output drivers can minimize digital power consumption. The data in Figure 81, Figure 82, and Figure 83 was taken using a 70 MHz analog input signal, with a 5 pF load on each output driver.

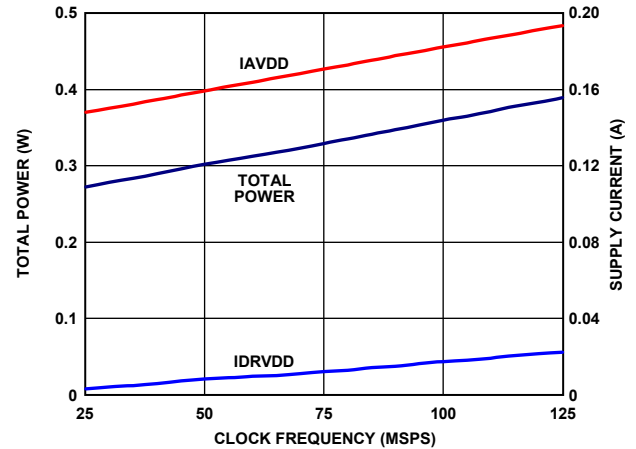

Figure 81. AD9255-125 Power and Current vs. Sample Rate

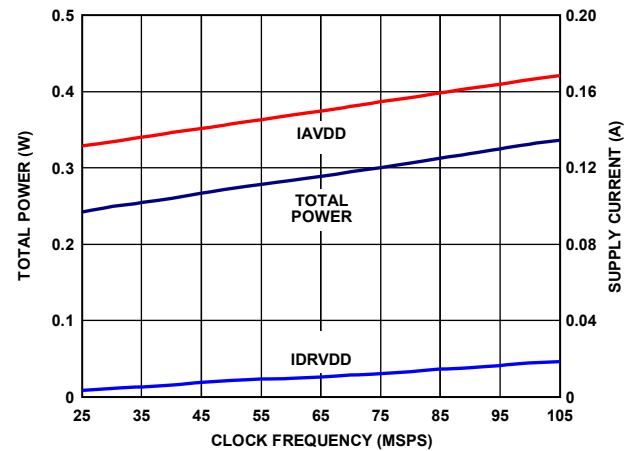

Figure 82. AD9255-105 Power and Current vs. Sample Rate

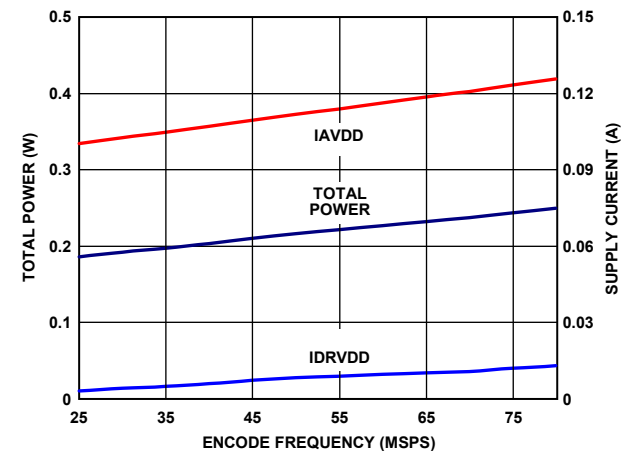

Figure 83. AD9255-80 Power and Current vs. Sample Rate

By asserting PDWN (either through the SPI port or by asserting the PDWN pin high), the AD9255 is placed in power-down mode. In this state, the ADC typically dissipates 0.05 mW. During power-down, the output drivers are placed in a high impedance state; asserting the PDWN pin low returns the AD9255 to its normal operating mode.

Low power dissipation in power-down mode is achieved by shutting down the reference, reference buffer, biasing networks, and clock. Internal capacitors are discharged when entering power-down mode and then must be recharged when returning to normal operation.

When using the SPI port interface, the user can place the ADC in power-down mode or standby mode. Standby mode allows the user to keep the internal reference circuitry powered when faster wake-up times are required. In addition, when using the SPI mode, the user can change the function of the external PDWN pin to either place the part in power-down or standby mode. See the Memory Map Register Descriptions section for more details.

DIGITAL OUTPUTS

The AD9255 output drivers can be configured to interface with 1.8 V CMOS logic families. The AD9255 can also be configured for LVDS outputs using a DRVDD supply voltage of 1.8 V. The AD9255 defaults to CMOS output mode but can be placed into LVDS mode either by setting the LVDS pin high or by using the SPI port to place the part into LVDS mode. Because most users do not toggle between CMOS and LVDS mode during operation, use of the LVDS pin is recommended to avoid any power-up loading issues on the CMOS configured outputs.

In CMOS output mode, the output drivers are sized to provide sufficient output current to drive a wide variety of logic families. However, large drive currents tend to cause current glitches on the supplies, which may affect converter performance. Applications requiring the ADC to drive large capacitive loads or large fanouts may require external buffers or latches.

In LVDS output mode, two output drive levels can be selected, either ANSI LVDS or reduced swing LVDS mode. Using the reduced swing LVDS mode lowers the DRVDD current and reduces power consumption. The reduced swing LVDS mode can be selected by asserting the LVDS_RS pin or by selecting this mode via the SPI port.

The output data format is selected for either offset binary or twos complement by setting the SCLK/DFS pin when operating in the external pin mode (see Table 12).

As detailed in AN-877 Application Note, *Interfacing to High Speed ADCs via SPI*, the data format can be selected for offset binary, twos complement, or gray code when using the SPI control.

Table 13. Output Data Format

Input (V)	Condition (V)	Offset Binary Output Mode	Twos Complement Mode	OR
VIN+ – VIN–	< –VREF – 0.5 LSB	00 0000 0000 0000	10 0000 0000 0000	1
VIN+ – VIN–	= –VREF	00 0000 0000 0000	10 0000 0000 0000	0
VIN+ – VIN–	= 0	10 0000 0000 0000	00 0000 0000 0000	0
VIN+ – VIN–	= +VREF – 1.0 LSB	11 1111 1111 1111	01 1111 1111 1111	0
VIN+ – VIN–	> +VREF – 0.5 LSB	11 1111 1111 1111	01 1111 1111 1111	1

Table 12. SCLK/DFS Mode Selection (External Pin Mode)

Voltage at Pin	SCLK/DFS	SDIO/DCS
AGND	Offset binary (default)	DCS disabled
SVDD	Twos complement	DCS enabled (default)

Digital Output Enable Function (OEB)

The AD9255 has a flexible three-state ability for the digital output pins. The three-state mode is enabled using the OEB pin or through the SPI interface. If the OEB pin is low, the output data drivers and DCOs are enabled. If the OEB pin is high, the output data drivers and DCOs are placed in a high impedance state. This OEB function is not intended for rapid access to the data bus. Note that OEB is referenced to the digital output driver supply (DRVDD) and should not exceed that supply voltage.

When using the SPI interface, the data and DCO outputs can be three-stated by using the output enable bar bit in Register 0x14.

TIMING

The AD9255 provides latched data with a pipeline delay of 12 clock cycles (12.5 clock cycles in LVDS mode). Data outputs are available one propagation delay (t_{PD}) after the rising edge of the clock signal.

Minimize the length of the output data lines and loads placed on them to reduce transients within the AD9255. These transients can degrade converter dynamic performance.

The lowest typical conversion rate of the AD9255 is 10 MSPS. At clock rates below 10 MSPS, dynamic performance can degrade.

Data Clock Output (DCO)

The AD9255 provides a single data clock output (DCO) pin in CMOS output mode and two differential data clock output (DCO) pins in LVDS mode intended for capturing the data in an external register. In CMOS output mode, the data outputs are valid on the rising edge of DCO, unless the DCO clock polarity has been changed via the SPI. In LVDS output mode, data is output as double data rate with the odd numbered output bits transitioning near the rising edge of DCO and the even numbered output bits transitioning near the falling edge of DCO. See Figure 2 for a graphical timing description.

BUILT-IN SELF-TEST (BIST) AND OUTPUT TEST

The AD9255 includes built-in self-test features designed to enable verification of the integrity of the part as well as facilitate board level debugging. A built-in self-test (BIST) feature is included that verifies the integrity of the digital datapath of the AD9255. Various output test options are also provided to place predictable values on the outputs of the AD9255.

BUILT-IN SELF-TEST (BIST)

The BIST is a thorough test of the digital portion of the selected AD9255 signal path. When enabled, the test runs from an internal pseudorandom noise (PN) source through the digital datapath starting at the ADC block output. The BIST sequence runs for 512 cycles and stops. The BIST signature value is placed in Register 0x24 and Register 0x25.

The outputs are not disconnected during this test, so the PN sequence can be observed as it runs. The PN sequence can be

continued from its last value or reset from the beginning, based on the value programmed in Register 0x0E, Bit 2. The BIST signature result varies based on the part configuration.

OUTPUT TEST MODES

The output test options are shown in Table 17. When an output test mode is enabled, the analog section of the ADC is disconnected from the digital back end blocks and the test pattern is run through the output formatting block. Some of the test patterns are subject to output formatting, and some are not. The seed value for the PN sequence tests can be forced if the PN reset bits are used to hold the generator in reset mode by setting Bit 4 or Bit 5 of Register 0x0D. These tests can be performed with or without an analog signal (if present, the analog signal is ignored), but they do require an encode clock. For more information, see AN-877 Application Note, *Interfacing to High Speed ADCs via SPI*.

SERIAL PORT INTERFACE (SPI)

The AD9255 serial port interface (SPI) allows the user to configure the converter for specific functions or operations through a structured register space provided inside the ADC. The SPI gives the user added flexibility and customization, depending on the application. Addresses are accessed via the serial port and can be written to, or read from, via the port. Memory is organized into bytes that can be further divided into fields, which are documented in the Memory Map section. For detailed operational information, see AN-877 Application Note, *Interfacing to High Speed ADCs via SPI*.

CONFIGURATION USING THE SPI

Three pins define the SPI of this ADC: the SCLK/DFS pin, the SDIO/DCS pin, and the CSB pin (see Table 14). The SCLK/DFS (a serial clock) is used to synchronize the read and write data presented from and to the ADC. The SDIO/DCS (serial data input/output) is a dual-purpose pin that allows data to be sent and read from the internal ADC memory map registers. The CSB (chip select bar) is an active low control that enables or disables the read and write cycles.

Table 14. Serial Port Interface Pins

Pin Mnemonic	Function
SCLK/DFS	Serial clock. The SCLK function of the pin is for the serial shift clock input, which is used to synchronize serial interface reads and writes.
SDIO/DCS	SDIO is the serial data input/output function of the pin. A dual-purpose pin that typically serves as an input or an output, depending on the instruction being sent and the relative position in the timing frame.
CSB	Chip select bar. An active low control that gates the read and write cycles.

The falling edge of the CSB, in conjunction with the rising edge of the SCLK, determines the start of the framing. See Figure 84 and Table 5 for an example of the serial timing and its definitions.

Other modes involving the CSB are available. The CSB can be held low indefinitely, which permanently enables the device; this is called streaming. The CSB can stall high between bytes to allow for additional external timing. When CSB is tied high at power-up, SPI functions are placed in high impedance mode. This mode turns on any SPI pin secondary functions. When CSB is toggled low after power-up, the part remains in SPI mode and does not revert back to pin mode.

During an instruction phase, a 16-bit instruction is transmitted. Data follows the instruction phase, and its length is determined by the W0 and W1 bits.

All data is composed of 8-bit words. The first bit of the first byte in a multibyte serial data transfer frame indicates whether a read command or a write command is issued. This allows the serial data input/output (SDIO) pin to change direction from an input to an output.

In addition to word length, the instruction phase determines whether the serial frame is a read or write operation, allowing the serial port to be used both to program the chip and to read the contents of the on-chip memory. If the instruction is a readback operation, performing a readback causes the serial data input/output (SDIO) pin to change direction from an input to an output at the appropriate point in the serial frame.

Data can be sent in MSB-first mode or in LSB-first mode. MSB first is the default on power-up and can be changed via the SPI port configuration register. For more information about this and other features, see AN-877 Application Note, *Interfacing to High Speed ADCs via SPI*.

HARDWARE INTERFACE

The pins described in Table 14 comprise the physical interface between the user programming device and the serial port of the AD9255. When using the SPI interface, the SCLK pin and the CSB pin function as inputs. The SDIO pin is bidirectional, functioning as an input during write phases and as an output during readback.

The AD9255 has a separate supply pin for the SPI interface, SVDD. The SVDD pin can be set at any level between 1.8 V and 3.3 V to enable operation with a SPI bus at these voltages without requiring level translation. If the SPI port is not used, SVDD can be tied to the DRVDD voltage.

The SPI interface is flexible enough to be controlled by either FPGAs or microcontrollers. One method for SPI configuration is described in detail in AN-812 Application Note, *Microcontroller-Based Serial Port Interface (SPI) Boot Circuit*.

The SPI port should not be active during periods when the full dynamic performance of the converter is required. Because the SCLK signal, the CSB signal, and the SDIO signal are typically asynchronous to the ADC clock, noise from these signals can degrade converter performance. If the on-board SPI bus is used for other devices, it may be necessary to provide buffers between this bus and the AD9255 to prevent these signals from transitioning at the converter inputs during critical sampling periods.

Some pins serve a dual function when the SPI interface is not being used. When the pins are tied to AVDD or ground during device power-on, they are associated with a specific function. The Digital Outputs section describes the alternate functions that are supported on the AD9255.

CONFIGURATION WITHOUT THE SPI

In applications that do not interface to the SPI control registers, the SDIO/DCS pin and the SCLK/DFS pin serve as standalone CMOS-compatible control pins. When the device is powered up, it is assumed that the user intends to use the pins as static control lines for the duty cycle stabilizer and output data format feature control. In this mode, connect the CSB chip select to AVDD, which disables the serial port interface.

The OEB pin, the DITHER pin, the LVDS pin, the LVDS_RS pin, and the PDWN pin are active control lines in both external pin mode and SPI mode. The input from these pins or the SPI register setting (the logical OR of the SPI bit and the pin function) is used to determine the mode of operation for the part.

Table 15. Mode Selection

Pin	External Voltage	Configuration
SDIO/DCS	SVDD (default)	Duty cycle stabilizer enabled
	AGND	Duty cycle stabilizer disabled
SCLK/DFS	SVDD	Twos complement enabled
	AGND (default)	Offset binary enabled
OEB	DRVDD	Outputs in high impedance
	AGND (default)	Outputs enabled
PDWN	AVDD	Chip in power-down or standby mode
	AGND (default)	Normal operation
LVDS	AGND (default)	CMOS output mode
	AVDD	LVDS output mode
	AGND (default)	ANSI LVDS output levels
LVDS_RS	AVDD	Reduced swing LVDS output levels
	AGND (default)	Dither disabled
DITHER	AVDD	Dither enabled

SPI ACCESSIBLE FEATURES

Table 16 provides a brief description of the general features that are accessible via the SPI. These features are described in detail in AN-877 Application Note, *Interfacing to High Speed ADCs via SPI*. The AD9255 part-specific features are described in detail following Table 17, the external memory map register table.

Table 16. Features Accessible Using the SPI

Feature Name	Description
Mode	Allows the user to set either power-down mode or standby mode
Clock	Allows the user to access the DCS, set the clock divider, set the clock divider phase, and enable the SYNC input
Offset	Allows the user to digitally adjust the converter offset
Test I/O	Allows the user to set test modes to have known data on output bits
Output Mode	Allows the user to set the output mode
Output Phase	Allows the user to set the output clock polarity
Output Delay	Allows the user to vary the DCO delay
VREF	Allows the user to set the reference voltage

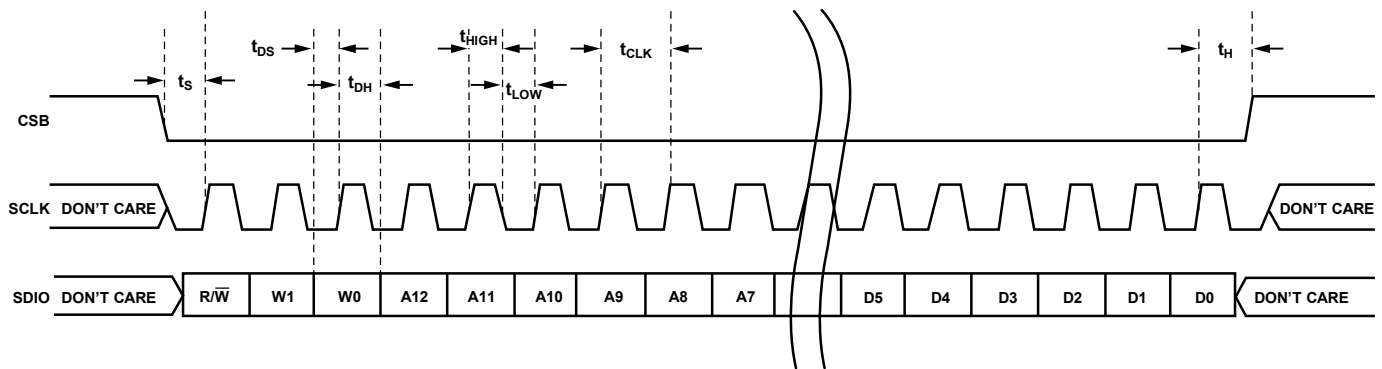

Figure 84. Serial Port Interface Timing Diagram

08505-055

MEMORY MAP

READING THE MEMORY MAP REGISTER TABLE

Each row in the memory map register table has eight bit locations. The memory map is roughly divided into four sections: the chip configuration registers (Address 0x00 to Address 0x02); the transfer register (Address 0xFF); the ADC functions registers, including setup, control, and test (Address 0x08 to Address 0x30); and the digital feature control registers (Address 0x100).

The memory map register table (see Table 17) documents the default hexadecimal value for each hexadecimal address shown. The column with the heading, Bit 7 (MSB), is the start of the default hexadecimal value given. For example, Address 0x18, the VREF select register, has a hexadecimal default value of 0xC0. This means that Bit 7 = 1, Bit 6 = 1, and the remaining bits are 0s. This setting is the default reference selection setting. The default value uses a 2.0 V p-p reference. For more information on this function and others, see AN-877 Application Note, *Interfacing to High Speed ADCs via SPI*. This document details the functions controlled by Register 0x00 to Register 0x30. The remaining register, at Register 0x100, is documented in the Memory Map Register Descriptions section.

Open Locations

All address and bit locations that are not included in Table 17 are not currently supported for this device. Unused bits of a

valid address location should be written with 0s. Writing to these locations is required only when part of an address location is open (for example, Address 0x18). If the entire address location is open (for example, Address 0x13), this address location should not be written.

Default Values

After the AD9255 is reset, critical registers are loaded with default values. The default values for the registers are given in the memory map register table, Table 17.

Logic Levels

An explanation of logic level terminology follows:

- “Bit is set” is synonymous with “bit is set to Logic 1” or “writing Logic 1 for the bit.”
- “Clear a bit” is synonymous with “bit is set to Logic 0” or “writing Logic 0 for the bit.”

Transfer Register Map

Address 0x08 to Address 0x18 are shadowed. Writes to these addresses do not affect part operation until a transfer command is issued by writing 0x01 to Address 0xFF, setting the transfer bit. This allows these registers to be updated internally and simultaneously when the transfer bit is set. The internal update takes place when the transfer bit is set, and the bit autoclears.

MEMORY MAP REGISTER TABLE

All address and bit locations that are not included in Table 17 are not currently supported for this device.

Table 17. Memory Map Registers

Addr. (Hex)	Register Name	Bit 7 (MSB)	Bit 6	Bit 5	Bit 4	Bit 3	Bit 2	Bit 1	Bit 0 (LSB)	Default Value (Hex)	Default Notes/Comments
Chip Configuration Registers											
0x00	SPI port configuration	0	LSB first	Soft reset	1	1	Soft reset	LSB first	0	0x18	The nibbles are mirrored so LSB-first mode or MSB-first mode registers correctly, regardless of shift mode
0x01	Chip ID	8-Bit Chip ID[7:0], AD9255 = 0x65 (default)								0x65	Read only
0x02	Chip grade	Open	Open	Speed grade ID 01 = 125 MSPS 10 = 105 MSPS 11 = 80 MSPS	Open	Open	Open	Open	Open		Speed grade ID used to differentiate devices; read only
Transfer Register											
0xFF	Transfer	Open	Open	Open	Open	Open	Open	Open	Transfer	0x00	Synchronously transfers data from the master shift register to the slave
ADC Functions Registers											
0x08	Power modes	1	Open	External power-down pin function 0 = power-down 1 = standby	Open	Open	Open	Internal power-down mode 00 = normal operation 01 = full power-down 10 = standby 11 = normal operation	0x80	Determines various generic modes of chip operation	
0x09	Global clock	Open	Open	Open	Open	Open	Open	Open	Duty cycle stabilizer (default)	0x01	
0x0B	Clock divide (global)	Open	Open	Open	Open	Open	Clock divide ratio 000 = divide by 1 001 = divide by 2 010 = divide by 3 011 = divide by 4 100 = divide by 5 101 = divide by 6 110 = divide by 7 111 = divide by 8	0x00	Clock divide values other than 000 automatically cause the duty stabilizer to become active.		
0x0D	Test mode	Open	Open	Reset PN23 generator	Reset PN9 generator	Open	Output test mode 000 = off (default) 001 = midscale short 010 = positive FS 011 = negative FS 100 = alternating checkerboard 101 = PN 23 sequence 110 = PN 9 sequence 111 = one/zero word toggle	0x00	When this register is set, the test data is placed on the output pins in place of normal data		
0x0E	BIST enable	Open	Open	Open	Open	Open	Reset BIST sequence	Open	BIST enable	0x04	

Addr. (Hex)	Register Name	Bit 7 (MSB)	Bit 6	Bit 5	Bit 4	Bit 3	Bit 2	Bit 1	Bit 0 (LSB)	Default Value (Hex)	Default Notes/Comments	
0x14	Output mode	Drive strength 0 = ANSI LVDS 1 = reduced LVDS	Output type 0 = CMOS 1 = LVDS	Open	Output enable bar	Open	Output invert	Output format 00 = offset binary 01 = twos complement 10 = gray code 11 = offset binary		0x00	Configures the outputs and the format of the data	
0x16	Clock phase control	Invert DCO clock	Open	Open	Open	Open	Input clock divider phase adjust 000 = no delay 001 = 1 input clock cycle 010 = 2 input clock cycles 011 = 3 input clock cycles 100 = 4 input clock cycles 101 = 5 input clock cycles 110 = 6 input clock cycles 111 = 7 input clock cycles			0x00	Allows selection of clock delays into the input clock divider	
0x17	DCO output delay	Open	Open	Open	DCO clock delay ($delay = 2500 \text{ ps} \times register \ value / 31$) 00000 = 0 ps 00001 = 81 ps 00010 = 161 ps ... 11110 = 2419 ps 11111 = 2500 ps					0x00		
0x18	VREF select	Reference voltage selection 00 = 1.25 V p-p 01 = 1.5 V p-p 10 = 1.75 V p-p 11 = 2.0 V p-p (default)		Open	Open	Open	Open	Open	Open	0xC0		
0x24	BIST signature LSB	BIST Signature[7:0]									0x00	Read only
0x25	BIST signature MSB	BIST Signature[15:8]									0x00	Read only
0x30	Dither enable	Open	Open	Open	Dither enable	Open	Open	Open	Open	0x00		
Digital Feature Control Register												
0x100	Sync control	Open	Open	Open	Open	Open	Clock divider next sync only	Clock divider sync enable	Master sync enable	0x00		

MEMORY MAP REGISTER DESCRIPTIONS

For additional information about functions controlled in Register 0x00 to Register 0xFF, see AN-877 Application Note, *Interfacing to High Speed ADCs via SPI*.

Sync Control (Register 0x100)**Bits[7:3]—Reserved**

These bits are reserved.

Bit 2—Clock Divider Next Sync Only

If the master sync enable bit (Address 0x100, Bit 0) and the clock divider sync enable bit (Address 0x100, Bit 1) are high, Bit 2 allows the clock divider to sync to the first sync pulse it receives

and to ignore the rest. The clock divider sync enable bit (Address 0x100, Bit 1) resets after it syncs.

Bit 1—Clock Divider Sync Enable

Bit 1 gates the sync pulse to the clock divider. The sync signal is enabled when Bit 1 is high and Bit 0 is high. This is continuous sync mode.

Bit 0—Master Sync Enable

Bit 0 must be high to enable any of the sync functions. If the sync capability is not used, this bit should remain low to conserve power.

APPLICATIONS INFORMATION

DESIGN GUIDELINES

Before starting design and layout of the AD9255 as a system, it is recommended that the designer become familiar with these guidelines, which discuss the special circuit connections and layout requirements that are needed for certain pins.

Power and Ground Recommendations

When connecting power to the AD9255, it is recommended that two separate 1.8 V supplies be used. Use one supply for analog (AVDD); use a separate supply for the digital outputs (DRVDD). Several different decoupling capacitors can be used to cover both high and low frequencies. Locate these capacitors close to the point of entry at the PCB level and close to the pins of the part, with minimal trace length. The power supply for the SPI port, SVDD, should not contain excessive noise and should also be bypassed close to the part.

A single PCB ground plane should be sufficient when using the AD9255. With proper decoupling and smart partitioning of the PCB analog, digital, and clock sections, optimum performance is easily achieved.

LVDS Operation

The AD9255 can be configured for CMOS or LVDS output mode on power-up using the LVDS pin, Pin 44. If LVDS operation is desired, connect Pin 44 to AVDD. LVDS operation can also be enabled through the SPI port. If CMOS operation is desired, connect Pin 44 to AGND.

Exposed Paddle Thermal Heat Slug Recommendations

It is mandatory that the exposed paddle on the underside of the ADC be connected to the analog ground (AGND) to achieve the best electrical and thermal performance. A continuous, exposed (no solder mask) copper plane on the PCB should mate to the AD9255 exposed paddle, Pin 0. The copper plane

should have several vias to achieve the lowest possible resistive thermal path for heat dissipation to flow through the bottom of the PCB. Fill or plug these vias with nonconductive epoxy.

To maximize the coverage and adhesion between the ADC and the PCB, overlay a silkscreen to partition the continuous plane on the PCB into several uniform sections. This provides several tie points between the ADC and the PCB during the reflow process. Using one continuous plane with no partitions guarantees only one tie point between the ADC and the PCB. For detailed information about packaging and PCB layout of chip scale packages, see the AN-772 Application Note, *A Design and Manufacturing Guide for the Lead Frame Chip Scale Package (LFCSP)*, at www.analog.com.

VCM

Decouple the VCM pin to ground with a 0.1 μF capacitor, as shown in Figure 67.

RBIAS

The AD9255 requires that a 10 k Ω resistor be placed between the RBIAS pin and ground. This resistor sets the master current reference of the ADC core and should have at least a 1% tolerance.

Reference Decoupling

Decouple the VREF pin externally to ground with a low ESR, 1.0 μF capacitor in parallel with a low ESR, 0.1 μF ceramic capacitor.

SPI Port

The SPI port should not be active during periods when the full dynamic performance of the converter is required. Because the SCLK, CSB, and SDIO signals are typically asynchronous to the ADC clock, noise from these signals can degrade converter performance. If the on-board SPI bus is used for other devices, it may be necessary to provide buffers between this bus and the AD9255 to keep these signals from transitioning at the converter inputs during critical sampling periods.

OUTLINE DIMENSIONS

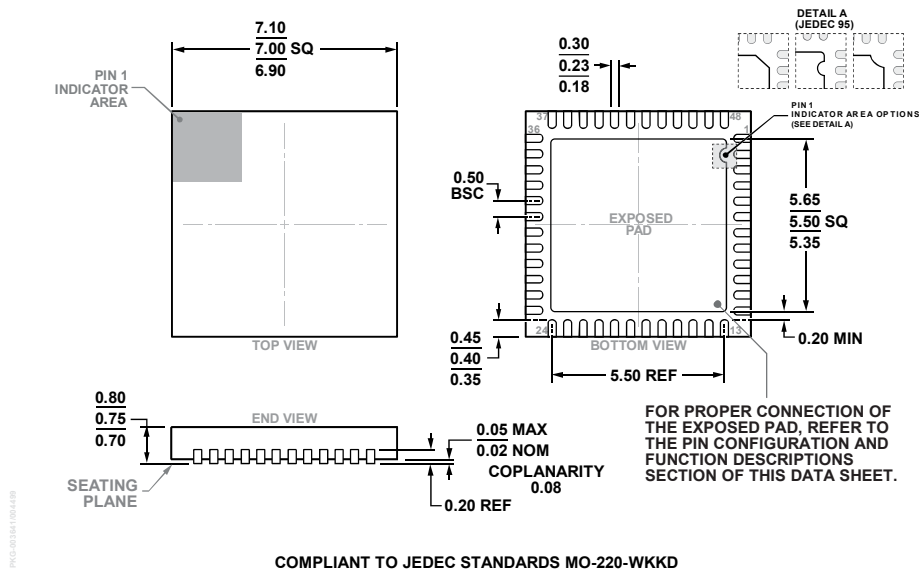

COMPLIANT TO JEDEC STANDARDS MO-220-WKGD

Figure 85. 48-Lead Lead Frame Chip Scale Package [LFCSP]
7 mm × 7 mm Body and 0.75 mm Package Height
(CP-48-9)

Dimensions shown in millimeters

ORDERING GUIDE

Model ¹	Temperature Range	Package Description	Package Option
AD9255BCPZ-125	−40°C to +85°C	48-Lead Lead Frame Chip Scale Package [LFCSP]	CP-48-9
AD9255BCPZRL7-125	−40°C to +85°C	48-Lead Lead Frame Chip Scale Package [LFCSP]	CP-48-9
AD9255BCPZ-105	−40°C to +85°C	48-Lead Lead Frame Chip Scale Package [LFCSP]	CP-48-9
AD9255BCPZRL7-105	−40°C to +85°C	48-Lead Lead Frame Chip Scale Package [LFCSP]	CP-48-9
AD9255BCPZ-80	−40°C to +85°C	48-Lead Lead Frame Chip Scale Package [LFCSP]	CP-48-9
AD9255BCPZRL7-80	−40°C to +85°C	48-Lead Lead Frame Chip Scale Package [LFCSP]	CP-48-9
AD9255-125EBZ		Evaluation Board	
AD9255-105EBZ		Evaluation Board	
AD9255-80EBZ		Evaluation Board	

¹ Z = RoHS Compliant Part.

NOTES

NOTES

NOTES

Mouser Electronics

Authorized Distributor

Click to View Pricing, Inventory, Delivery & Lifecycle Information:

[Analog Devices Inc.:](#)

[AD9255BCPZ-105](#) [AD9255BCPZ-80](#) [AD9255-80EBZ](#) [AD9255-105EBZ](#) [AD9255BCPZ-125](#) [AD9255BCPZRL7-105](#)
[AD9255BCPZRL7-125](#) [AD9255BCPZRL7-80](#) [AD9255-125EBZ](#)