

FEATURES**AC PERFORMANCE**

500 ns Settling to 0.01% for 10 V Step
75 V/ μ s Slew Rate
0.0001% Total Harmonic Distortion (THD)
13 MHz Gain Bandwidth
Internal Compensation for Gains of +2 or Greater

DC PERFORMANCE

0.5 mV max Offset Voltage (AD746B)
10 μ V/ $^{\circ}$ C max Drift (AD746B)
175 V/mV min Open Loop Gain (AD746B)
2 μ V p-p Noise, 0.1 Hz to 10 Hz
Available in Plastic Mini-DIP, Cerdip and Surface Mount Packages
Available in Tape and Reel in Accordance with EIA-481A Standard
MIL-STD-883B Processing also Available
Single Version: AD744

APPLICATIONS

Dual Output Buffers for 12- and 14-Bit DACs
Input Buffers for Precision ADCs, Wideband Preamplifiers and Low Distortion Audio Circuitry

PRODUCT DESCRIPTION

The AD746 is a dual operational amplifier, consisting of two AD744 BiFET op amps on a single chip. These precision monolithic op amps offer excellent dc characteristics plus rapid settling times, high slew rates and ample bandwidths. In addition, the AD746 provides the close matching ac and dc characteristics inherent to amplifiers sharing the same monolithic die.

The single pole response of the AD746 provides fast settling: 500 ns to 0.01%. This feature, combined with its high dc precision, makes it suitable for use as a buffer amplifier for 12- or 14-bit DACs and ADCs. Furthermore, the AD746's low total harmonic distortion (THD) level of 0.0001% and very close matching ac characteristics make it an ideal amplifier for many demanding audio applications.

The AD746 is internally compensated for stable operation as a unity gain inverter or as a noninverting amplifier with a gain of 2 or greater. It is available in four performance grades. The AD746J is rated over the commercial temperature range of 0 to +70 $^{\circ}$ C. The AD746A and AD746B are rated over the industrial temperature range of -40 $^{\circ}$ C to +85 $^{\circ}$ C. The AD746S is rated over the military temperature range of -55 $^{\circ}$ C to +125 $^{\circ}$ C and is available processed to MIL-STD-883B, Rev. C.

REV. B

Information furnished by Analog Devices is believed to be accurate and reliable. However, no responsibility is assumed by Analog Devices for its use, nor for any infringements of patents or other rights of third parties which may result from its use. No license is granted by implication or otherwise under any patent or patent rights of Analog Devices.

CONNECTION DIAGRAM

Plastic Mini-DIP (N)
Cerdip (Q) and
Plastic SOIC (R) Packages

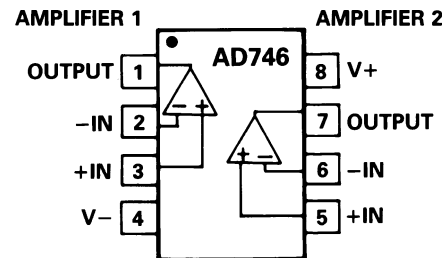

The AD746 is available in three 8-pin packages: plastic mini DIP, hermetic cerdip and surface mount (SOIC).

PRODUCT HIGHLIGHTS

1. The AD746 offers exceptional dynamic response for high speed data acquisition systems. It settles to 0.01% in 500 ns and has a 100% tested minimum slew rate of 50 V/ μ s (AD746B).
2. Outstanding dc precision is provided by a combination of Analog Devices' advanced processing technology, laser wafer drift trimming and well-matched ion-implanted JFETs. Input offset voltage, input bias current and input offset current are specified in the warmed-up condition and are 100% tested.
3. Differential and multichannel systems will benefit from the AD746's very close matching of ac characteristics. Input offset voltage specs are fully tested and guaranteed to a maximum of 0.5 mV (AD746B).
4. The AD746 has very close, guaranteed matching of input bias current between its two amplifiers.
5. Unity gain stable version AD712 also available.

AD746—SPECIFICATIONS (@ +25°C and ±15 V dc, unless otherwise noted)

Model	Conditions	AD746J/A			AD746B			AD746S			Units	
		Min	Typ	Max	Min	Typ	Max	Min	Typ	Max		
INPUT OFFSET VOLTAGE ¹ Initial Offset Offset vs. Temperature vs. Supply ² (PSRR) vs. Supply (PSRR) Long Term Stability	T _{MIN} to T _{MAX}		0.3	1.5		0.25	0.5		0.3	1.0	mV	
												mV
	T _{MIN} to T _{MAX}		12	20		5	10		12	20		μV/°C
			80	95		84	100		80	95		dB
		80	15		84	15		80	15		dB	
											μV/month	
INPUT BIAS CURRENT ³ Either Input Either Input @ T _{MAX} Either Input Offset Current Offset Current @ T _{MAX}	V _{CM} = 0 V		110	250		110	150		110	250	pA	
	V _{CM} = 0 V		2.5/7	5.7/16		7	9.6		113	256	nA	
	V _{CM} = +10 V		145	350		145	200		145	350	pA	
	V _{CM} = 0 V		45	125		45	75		45	125	pA	
	V _{CM} = 0 V		1.0/3	2.8/8		3	4.8		45	128	nA	
MATCHING CHARACTERISTICS Input Offset Voltage Input Offset Voltage Input Offset Voltage Drift Input Bias Current Crosstalk	T _{MIN} to T _{MAX}		0.6	1.5		0.3	0.5		0.6	1.0	mV	
												mV
												μV/°C
	@ 1 kHz @ 100 kHz		120	125		120	75		120	125		pA
			90			90			90			dB
											dB	
FREQUENCY RESPONSE Gain BW, Small Signal Slew Rate, Unity Gain Full Power Response Settling Time to 0.01% ⁴ Total Harmonic Distortion	G = -1	8	13		9	13		8	13		MHz	
	G = -1	45	75		50	75		45	75		V/μs	
	V _O = 20 V p-p		600			600			600		kHz	
	G = 1		0.5	0.75		0.5	0.75		0.5	0.75	μs	
	f = 1 kHz R ₁ ≥ 2 kΩ											%
	V _O = 3 V rms		0.0001			0.0001			0.0001			%
INPUT IMPEDANCE Differential Common Mode			2.5 × 10 ¹¹ 5.5			2.5 × 10 ¹¹ 5.5			2.5 × 10 ¹¹ 5.5		Ω pF	
			2.5 × 10 ¹¹ 5.5			2.5 × 10 ¹¹ 5.5			2.5 × 10 ¹¹ 5.5		Ω pF	
INPUT VOLTAGE RANGE Differential ⁵ Common-Mode Voltage Over Max Operating Range ⁶ Common-Mode Rejection Ratio	V _{CM} = ±10 V T _{MIN} to T _{MAX}		±20			±20			±20		V	
				+14.5, -11.5			+14.5, -11.5			+14.5, -11.5		V
	T _{MIN} to T _{MAX}		-11		+13	-11		+13	-11		+13	V
			78	88		82	88		78	88		dB
			76	84		80	84		76	84		dB
			72	84		78	84		72	84		dB
			70	80		74	80		70	80		dB
INPUT VOLTAGE NOISE	0.1 to 10 Hz		2			2			2		μV p-p	
	f = 10 Hz		45			45			45		nV/√Hz	
	f = 100 Hz		22			22			22		nV/√Hz	
	f = 1 kHz		18			18			18		nV/√Hz	
	f = 10 kHz		16			16			16		nV/√Hz	
INPUT CURRENT NOISE	f = 1 kHz		0.01			0.01			0.01		pA/√Hz	
OPEN LOOP GAIN	V _O = ±10 V R ₁ ≥ 2 kΩ	150	300		175	300		150	300		V/mV	
	T _{MIN} to T _{MAX}	75	200		75	200		65	175		V/mV	
OUTPUT CHARACTERISTICS Voltage Current Max Capacitive Load Driving Capability	R ₁ ≥ 2 kΩ	+13, -12.5	+13.9, -13.3		+13, -12.5	+13.9, -13.3		+13, -12.5	+13.9, -13.3		V	
	T _{MIN} to T _{MAX}	±12	+13.8, -13.1		±12	+13.8, -13.1		±12	+13.8, -13.1		V	
	Short Circuit		25			25			25		mA	
	Gain = -1		50			50			50		pF	
	Gain = -10		500			500			500		pF	
POWER SUPPLY Rated Performance Operating Range Quiescent Current		±4.5	±15	±18	±4.5	±15	±18	±4.5	±15	±18	V	
			7	10		7	8.0		7	10	V	
											mA	
TEMPERATURE RANGE Rated Performance		0 to +70/-40 to +85			-40 to +85			-55 to +125			°C	
PACKAGE OPTIONS 8-Pin Plastic Mini-DIP (N-8) 8-Pin Cerdip (Q-8) 8-Pin Surface Mount (R-8) Tape and Reel Chips		AD746JN AD746AQ			AD746BQ			AD746SQ				
		AD746JR										
		AD746JR-REEL										
								AD746SCHIPS				
TRANSISTOR COUNT		54			54			54				

NOTES

- ¹Input Offset Voltage specifications are guaranteed after 5 minutes of operation at $T_A = +25^\circ\text{C}$.
 - ²PSRR test conditions: $+V_S = 15\text{ V}$, $-V_S = -12\text{ V}$ to -18 V and $+V_S = 12\text{ V}$ to 18 V , $-V_S = -15\text{ V}$.
 - ³Bias Current Specifications are guaranteed maximum at either input after 5 minutes of operation at $T_A = +25^\circ\text{C}$. For higher temperature, the current doubles every 10°C .
 - ⁴Gain = -1, $R_I = 2\text{ k}$, $C_I = 10\text{ pF}$.
 - ⁵Defined as voltage between inputs, such that neither exceeds $\pm 10\text{ V}$ from ground.
 - ⁶Typically exceeding -14.1 V negative common-mode voltage on either input results in an output phase reversal.
- Specifications subject to change without notice.

Specifications in **boldface** are tested on all production units at final electrical test. Results from those tests are used to calculate outgoing quality levels. All min and max specifications are guaranteed, although only those shown in **boldface** are tested on all production units.

ABSOLUTE MAXIMUM RATINGS¹

Supply Voltage	$\pm 18\text{ V}$
Internal Power Dissipation ²	500 mW
Input Voltage	$\pm V_S$
Output Short Circuit Duration (For One Amplifier)	Indefinite
Differential Input Voltage	$+V_S$ and $-V_S$
Storage Temperature Range (Q)	-65°C to $+150^\circ\text{C}$
Storage Temperature Range (N, R)	-65°C to $+125^\circ\text{C}$
Operating Temperature Range	
AD746J	0°C to $+70^\circ\text{C}$
AD746A/B	-40°C to $+85^\circ\text{C}$
AD746S	-55°C to $+125^\circ\text{C}$

Lead Temperature Range (Soldering 60 seconds)	$+300^\circ\text{C}$
ESD Rating	

- NOTES**
- ¹Stresses above those listed under "Absolute Maximum Ratings" may cause permanent damage to the device. This is a stress rating only and functional operation of the device at these or any other conditions above those indicated in the operational section of this specification is not implied. Exposure to absolute maximum rating conditions for extended periods may affect device reliability.
 - ²8-Pin Plastic Package: $\theta_{JA} = 100^\circ\text{C/Watt}$, $\theta_{JC} = 50^\circ\text{C/Watt}$
 - 8-Pin Cerdip Package: $\theta_{JA} = 110^\circ\text{C/Watt}$, $\theta_{JC} = 30^\circ\text{C/Watt}$
 - 8-Pin Small Outline Package: $\theta_{JA} = 160^\circ\text{C/Watt}$, $\theta_{JC} = 42^\circ\text{C/Watt}$

METALIZATION PHOTOGRAPH

Contact factory for latest dimensions.
Dimensions shown in inches and (mm).

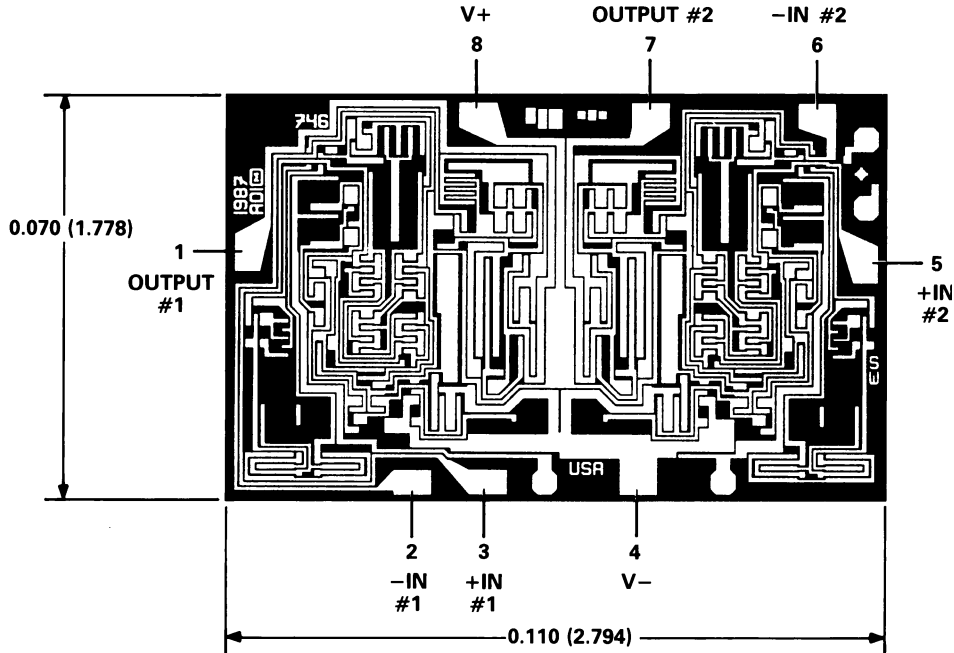

CAUTION

ESD (electrostatic discharge) sensitive device. Electrostatic charges as high as 4000 V readily accumulate on the human body and test equipment and can discharge without detection. Although the AD746 features proprietary ESD protection circuitry, permanent damage may occur on devices subjected to high energy electrostatic discharges. Therefore, proper ESD precautions are recommended to avoid performance degradation or loss of functionality.



AD746—Typical Characteristics

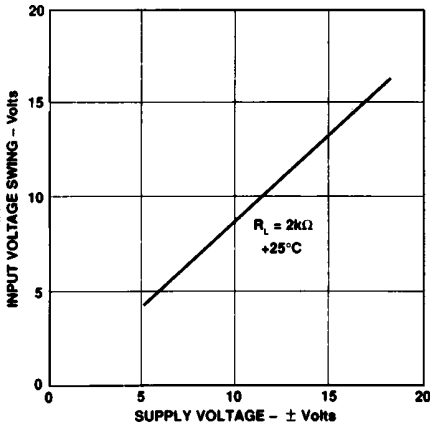

Figure 1. Input Voltage Swing vs. Supply Voltage

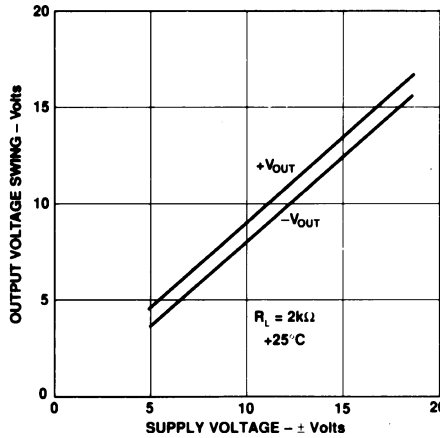

Figure 2. Output Voltage Swing vs. Supply Voltage

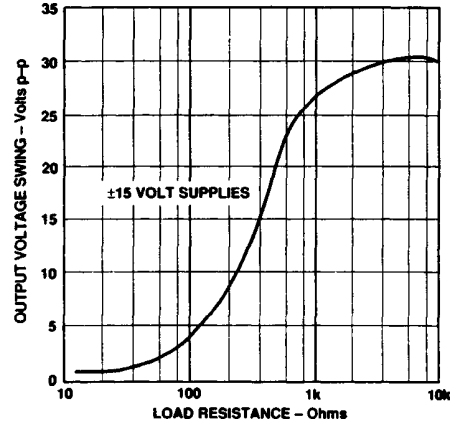

Figure 3. Output Voltage Swing vs. Load Resistance

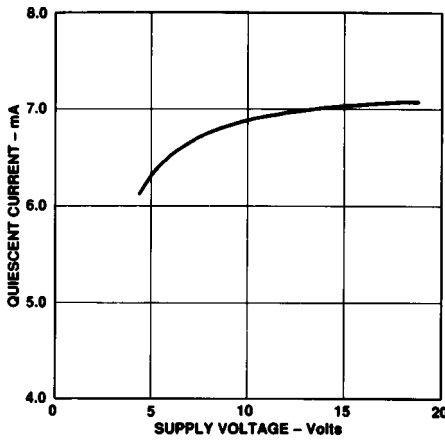

Figure 4. Quiescent Current vs. Supply Voltage

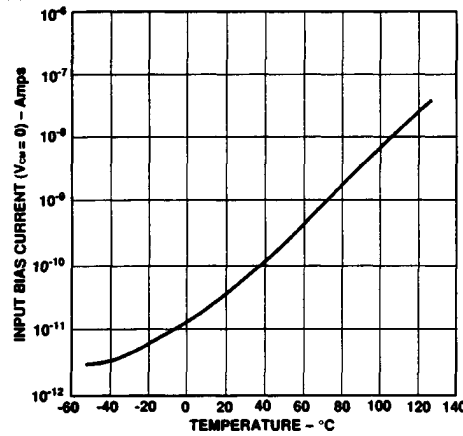

Figure 5. Input Bias Current vs. Temperature

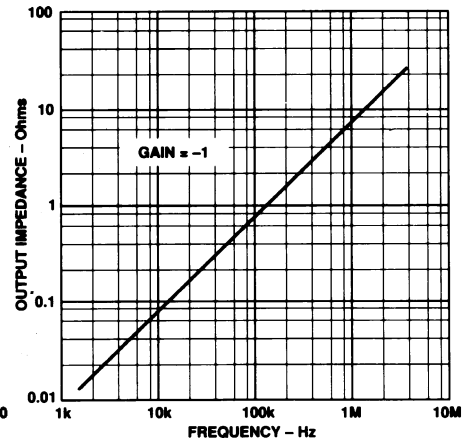

Figure 6. Output Impedance vs. Frequency

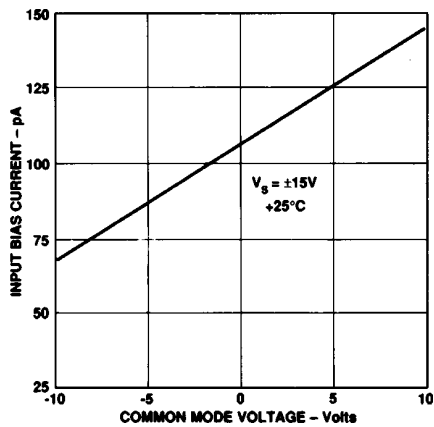

Figure 7. Input Bias Current vs. Common Mode Voltage

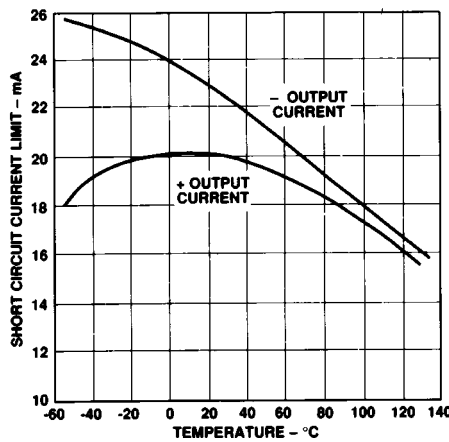

Figure 8. Short Circuit Current Limit vs. Temperature

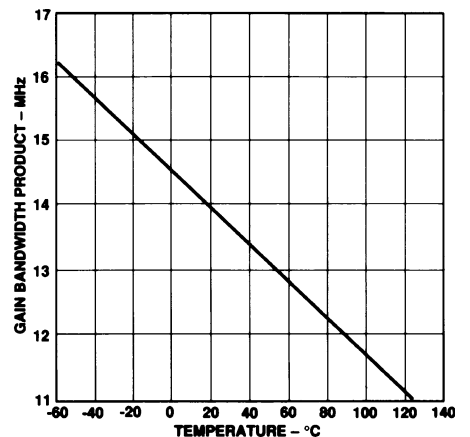

Figure 9. Gain Bandwidth Product vs. Temperature

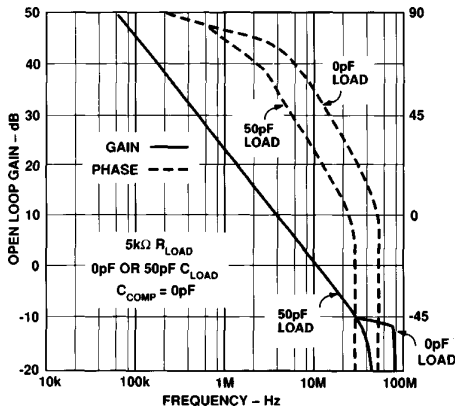

Figure 10. Open Loop Gain and Phase Margin vs. Frequency

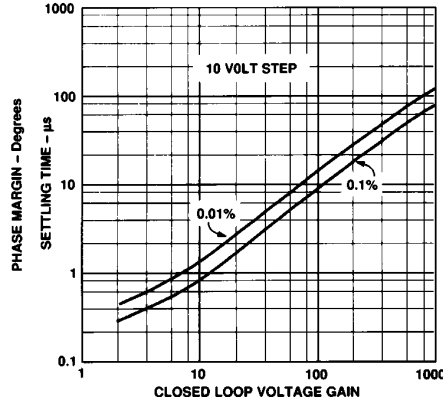

Figure 11. Settling Time vs. Closed Loop Voltage Gain

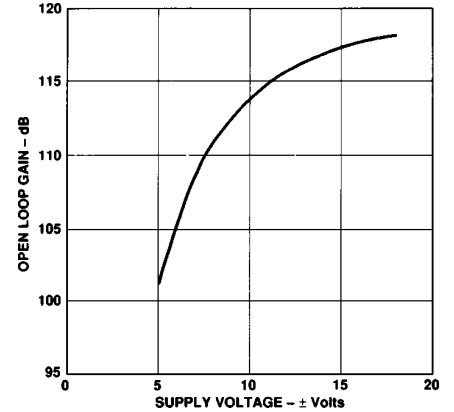

Figure 12. Open Loop Gain vs. Supply Voltage

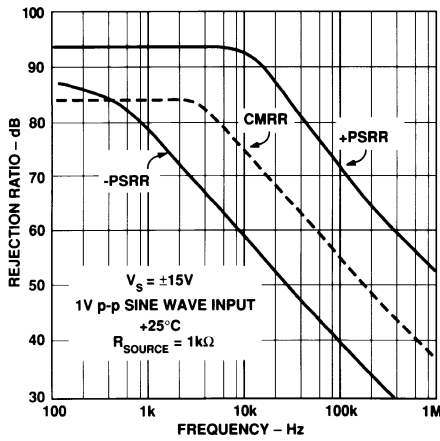

Figure 13. Common-Mode and Power Supply Rejection vs. Frequency

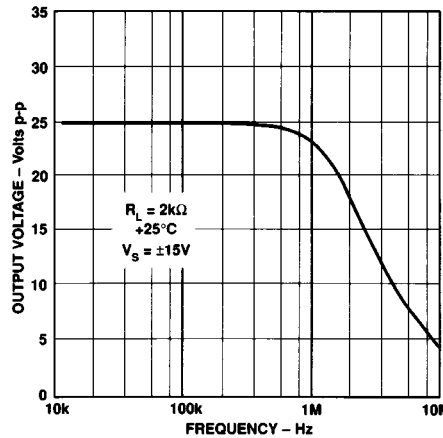

Figure 14. Large Signal Frequency Response

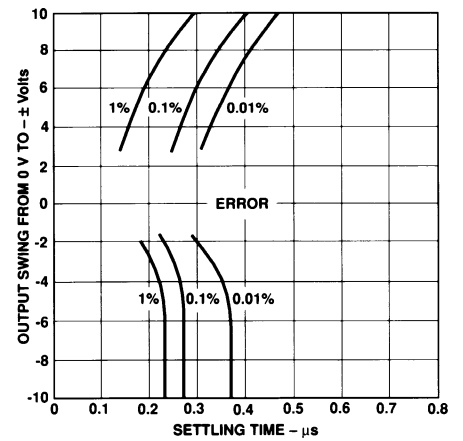

Figure 15. Output Swing and Error vs. Settling Time

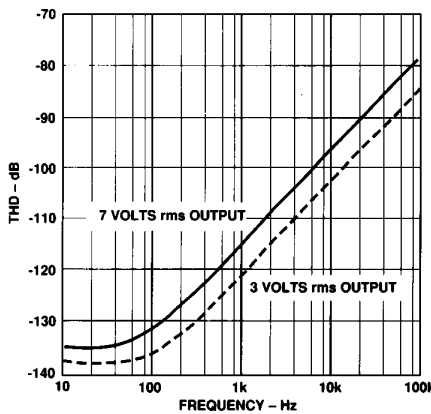

Figure 16. Total Harmonic Distortion vs. Frequency Using Circuit of Figure 19

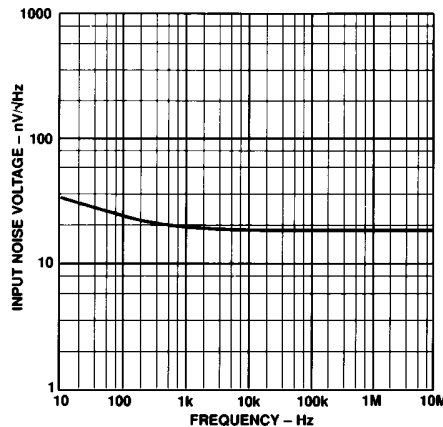

Figure 17. Input Noise Voltage Spectral Density

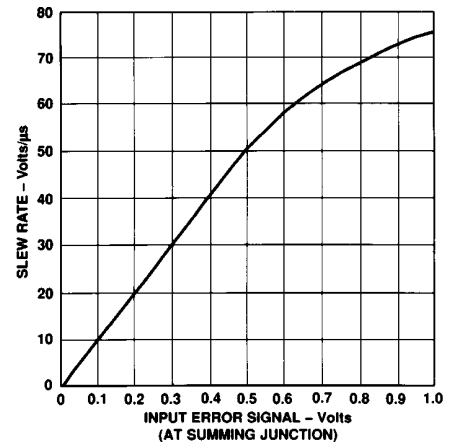

Figure 18. Slew Rate vs. Input Error Signal

AD746

POWER SUPPLY BYPASSING

The power supply connections to the AD746 must maintain a low impedance to ground over a bandwidth of 13 MHz or more. This is especially important when driving a significant resistive or capacitive load, since all current delivered to the load comes from the power supplies. Multiple high quality bypass capacitors are recommended for each power supply line in any critical application. A 0.1 μF ceramic and a 1 μF tantalum capacitor as shown in Figure 20 placed as close as possible to the amplifier

(with short lead lengths to power supply common) will assure adequate high frequency bypassing, in most applications. A minimum bypass capacitance of 0.1 μF should be used for any application.

If only one of the two amplifiers inside the AD746 is to be utilized, the unused amplifier should be connected as shown in Figure 21a. Note that the noninverting input should be grounded and that R_L and C_L are not required.

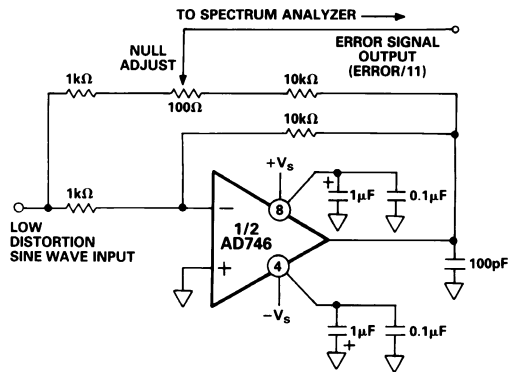

Figure 19. THD Test Circuit

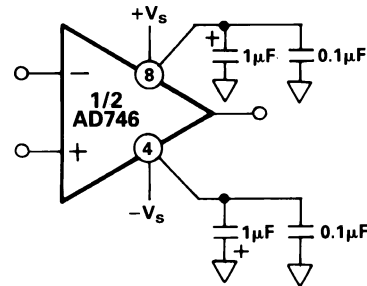

Figure 20. Power Supply Bypassing

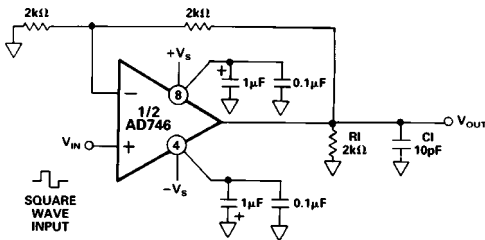

Figure 21a. Gain of 2 Follower

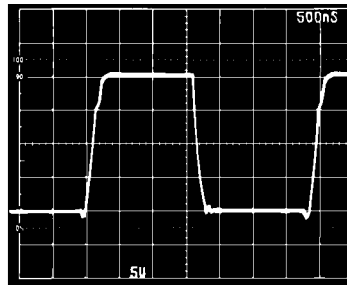

Figure 21b. Gain of 2 Follower Large Signal Pulse Response

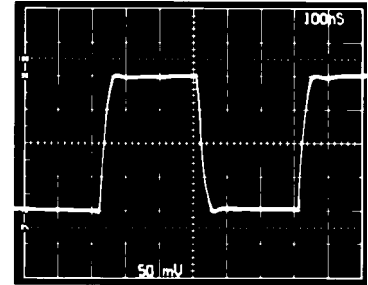

Figure 21c. Gain of 2 Follower Small Signal Pulse Response

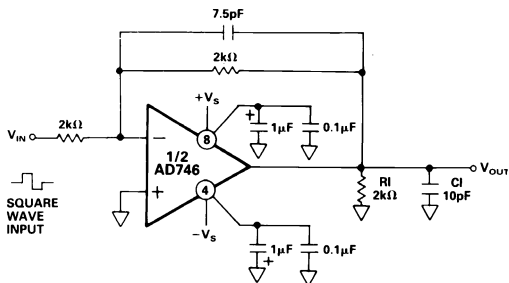

Figure 22a. Unity Gain Inverter

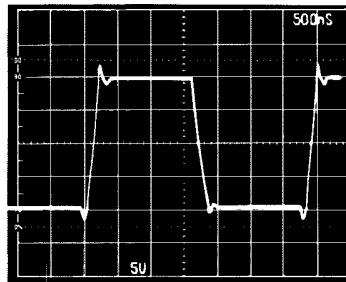

Figure 22b. Unity Gain Inverter Large Signal Pulse Response

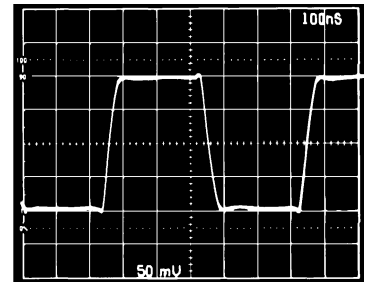
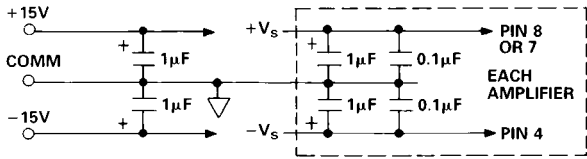
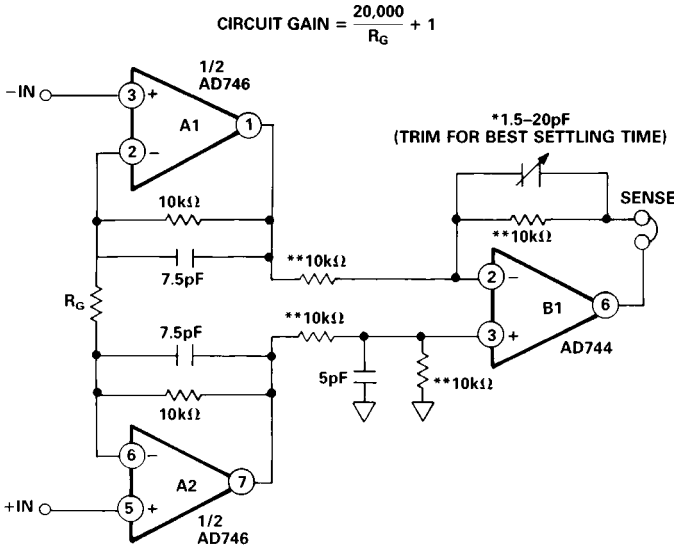

Figure 22c. Unity Gain Inverter Small Signal Pulse Response

A HIGH SPEED 3 OP AMP INSTRUMENTATION AMPLIFIER CIRCUIT

The instrumentation amplifier circuit shown in Figure 23 can provide a range of gains from 2 up to 1000 and higher. The circuit bandwidth is 2.5 MHz at a gain of 2 and 750 kHz at a gain of 10; settling time for the entire circuit is less than 2 μs to within 0.01% for a 10 volt step, (G = 10).



*VOLTRONICS SP20 TRIMMER CAPACITOR OR EQUIVALENT
 **RATIO MATCHED 1% METAL FILM RESISTORS

Figure 23. A High Performance, 3 Op Amp, Instrumentation Amplifier Circuit

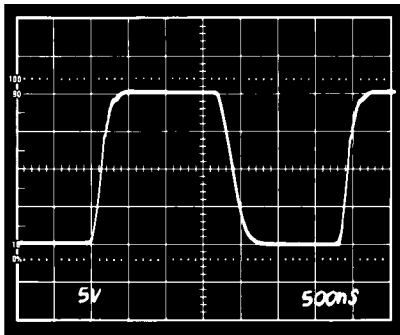

Figure 24. Pulse Response of the 3 Op Amp Instrumentation Amplifier. Gain = 10, Horizontal Scale: 0.5 μs/Div, Vertical Scale: 5 V/Div.

Table I. Performance Summary for the 3 Op Amp Instrumentation Amplifier Circuit

Gain	R _G	Bandwidth	T _{SETTLE} (0.01%)
2	20 kΩ	2.5 MHz	1.0 μs
10	4.04 kΩ	1 MHz	2.0 μs
100	404 Ω	290 kHz	5.0 μs

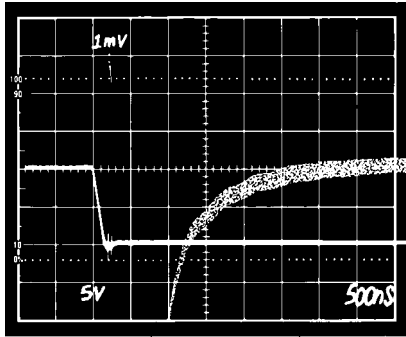

Figure 25. Settling Time of the 3 Op Amp Instrumentation Amplifier. Gain = 10, Horizontal Scale: 0.5 μs/Div, Vertical Scale: 5 V/Div. Error Signal Scale: 0.01%/Div.

THD Performance Considerations

The AD746 was carefully optimized to offer excellent performance in terms of total harmonic distortion (THD) in signal processing applications. The THD level when operating the AD746 in inverting gain applications will show a gradual rise from the distortion floor of 20 dB/decade (see Figure 28). In noninverting applications, care should be taken to balance the source impedances at both the inverting and noninverting inputs, to avoid distortion caused by the modulation of input capacitance inherent in all BiFET op amps.

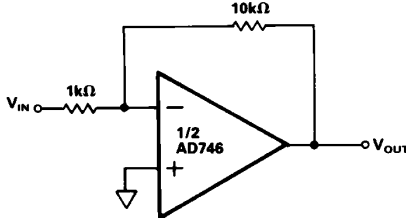

Figure 26. THD Measurement, Inverter Circuit

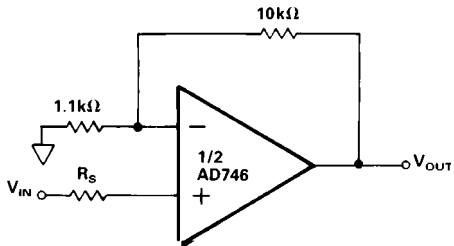

Figure 27. THD Measurement, Follower Circuit

AD746

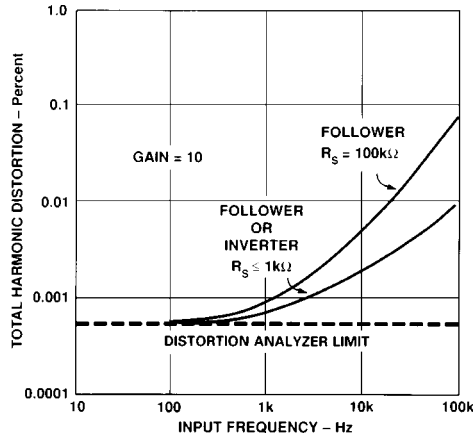

Figure 28. THD vs. Frequency Using Standard Distortion Analyzer

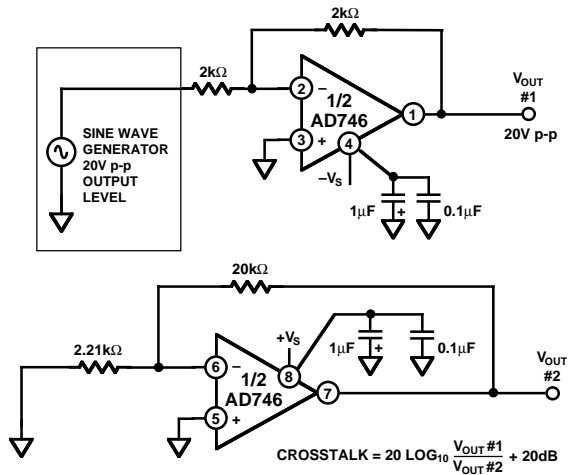

Figure 29. Crosstalk Test Circuit

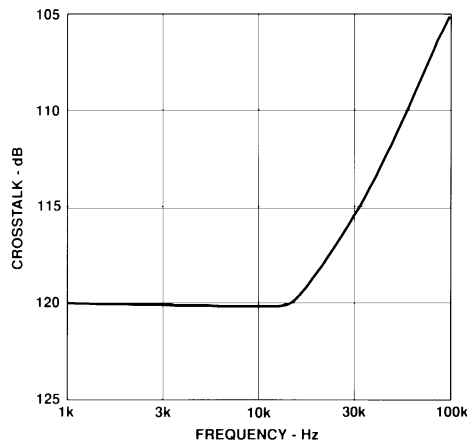
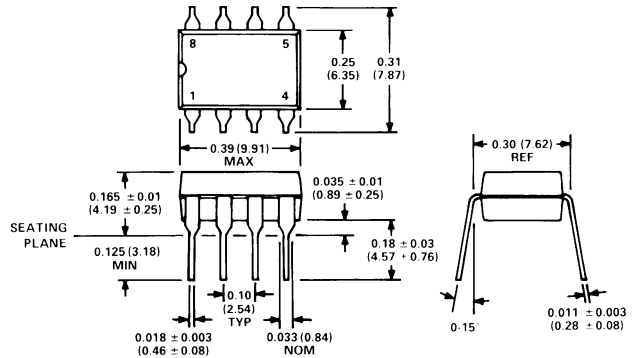

Figure 30. Crosstalk vs. Frequency

OUTLINE DIMENSIONS

Dimensions shown in inches and (mm).

Mini-DIP (N) Package



Cerdip (Q) Package

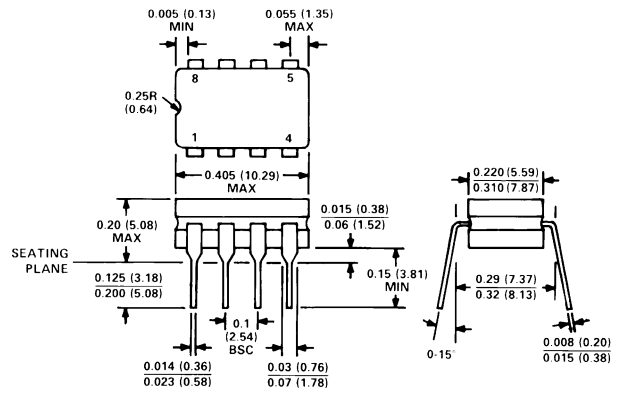

Plastic Small Outline (R) Package

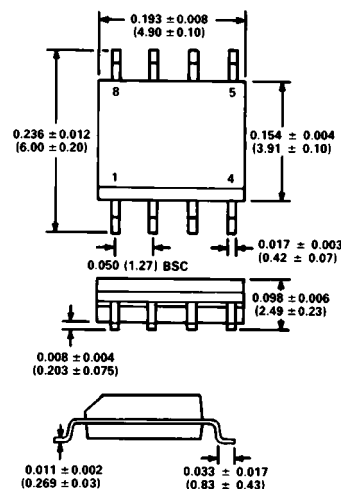

C1319-10-9/89

PRINTED IN U.S.A.

Mouser Electronics

Authorized Distributor

Click to View Pricing, Inventory, Delivery & Lifecycle Information:

[Analog Devices Inc.:](#)

[AD746JNZ](#) [AD746JRZ](#) [AD746SQ/883B](#)