

02/13 IL03801020Z  
(AWA115-586, IL00802007E)

**T0(3)-.../E**  
**T0(3)-.../EZ**  
**T0(3)-.../E/SVB**  
**T0(3)-.../EA/SVB**

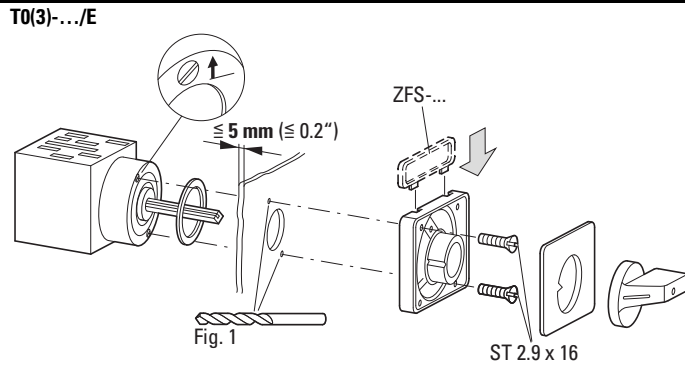

**T0(3)-.../EZ/OFS**  
**T0(3)-.../EZ**

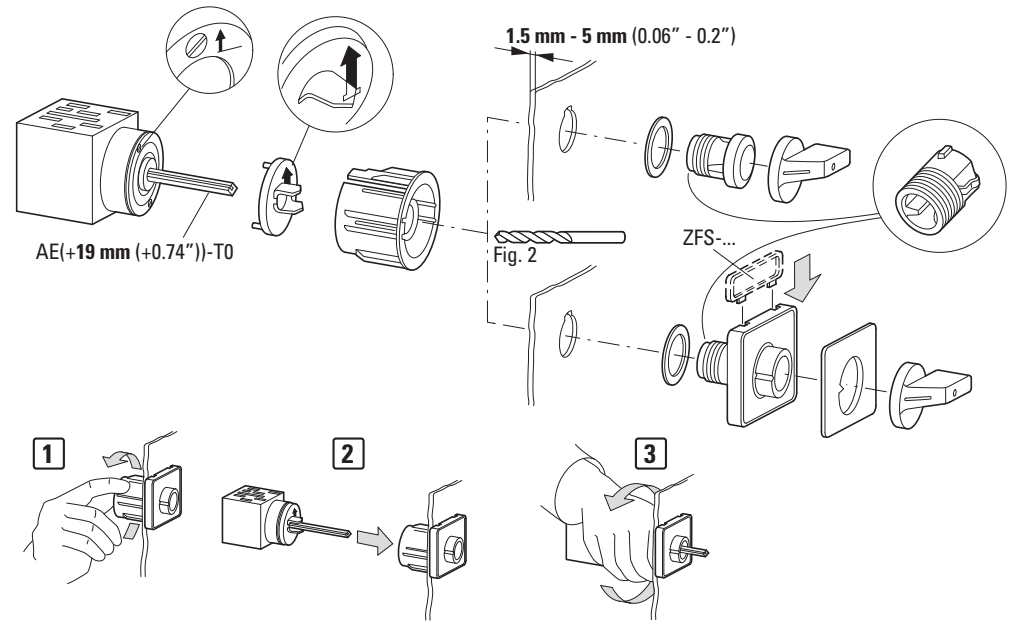

**UL/CSA:**

Suitable for use as Motor Branch Circuit Disconnecter means.

Short Circuit Withstand  
10 kA RMS SYM 600 V AC  
Max Fuse T0... – 20 A Class J  
T3... – 40 A Class J

Standard Short Circuit  
5 kA RMS SYM 600 V AC  
Max Fuse T0... – 50 A  
T3... – 80 A  
Max Cir. Bkr. T0... – 50 A  
T3... – 125 A

Switch or enclosure must be padlockable if used as a Motor Branch Circuit Disconnecter means.

**Fig. 1**  
[mm (in)]  
→ ≠ 1 : 1

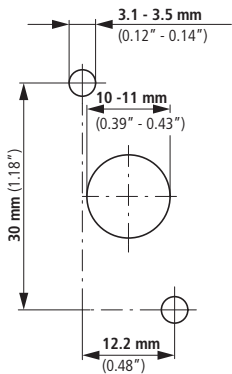

**Fig. 2**  
[mm (in)]  
→ ≠ 1 : 1

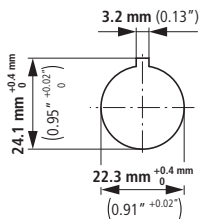

**T0(3)-.../E/SVB**

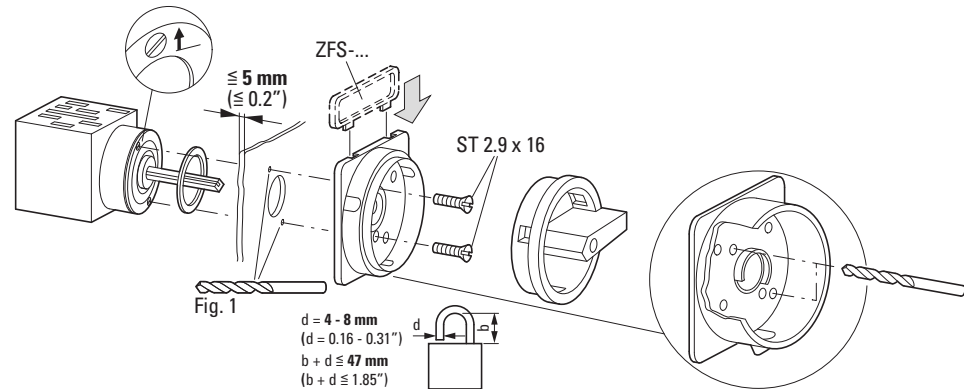

**T0(3)-.../EA/SVB**

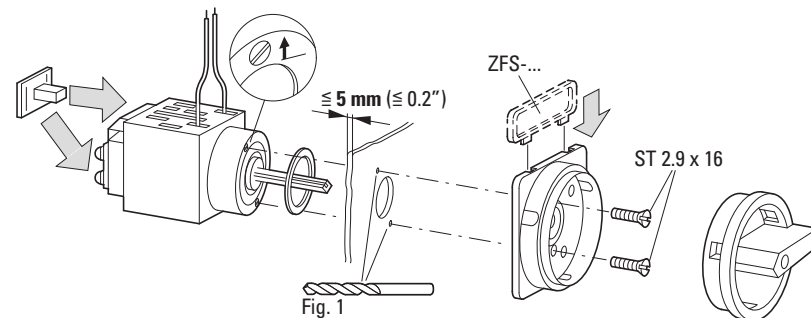

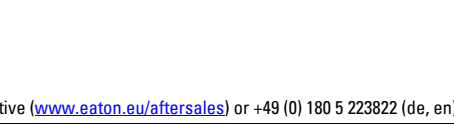
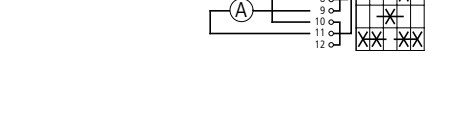
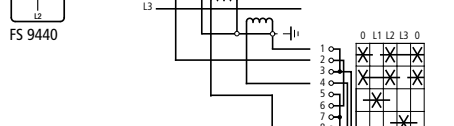
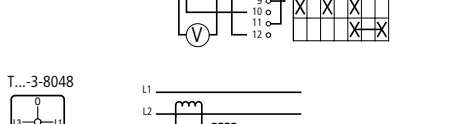
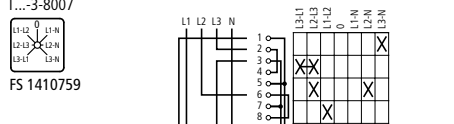
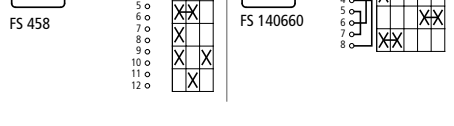
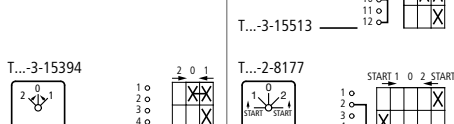
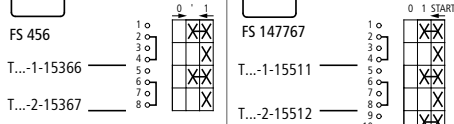
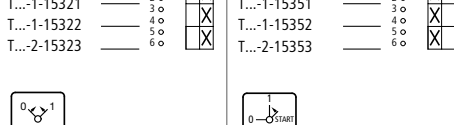
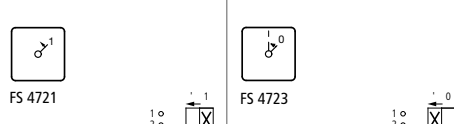
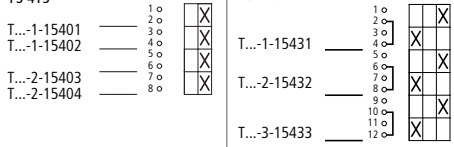
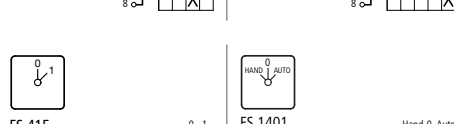
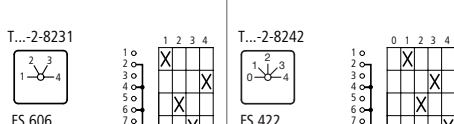
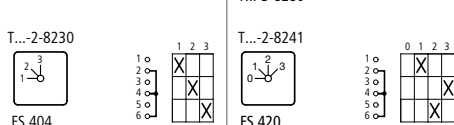
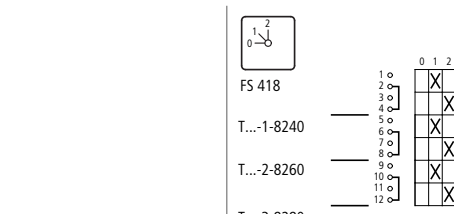
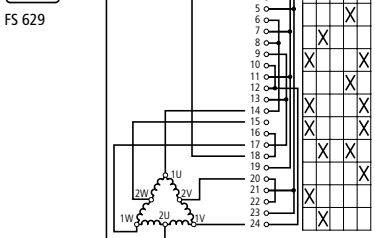
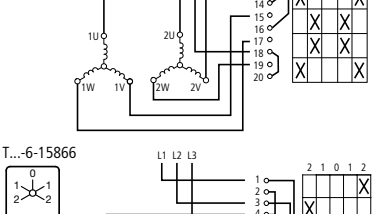
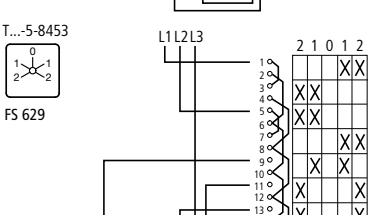
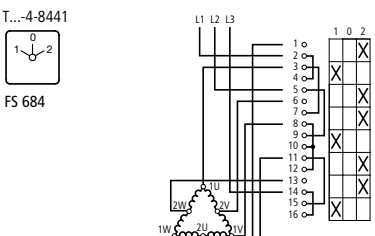
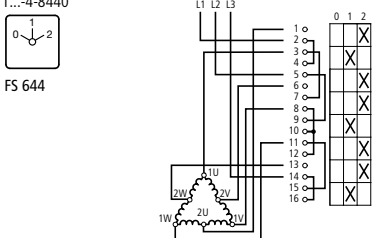
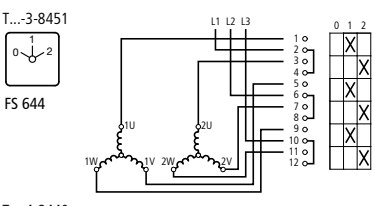
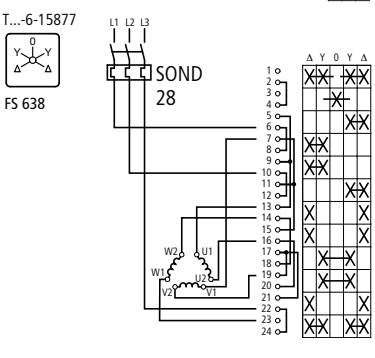
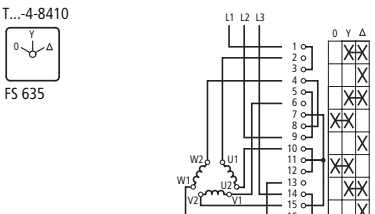
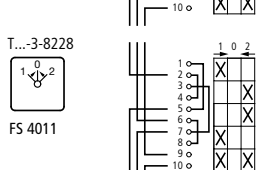
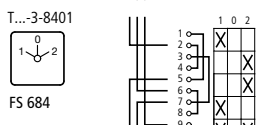
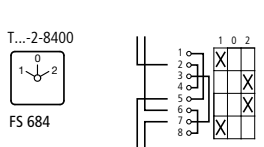
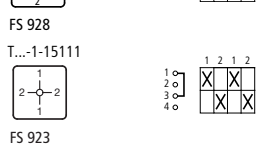
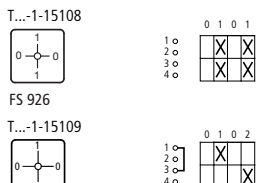
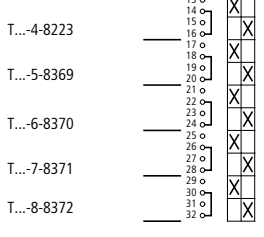
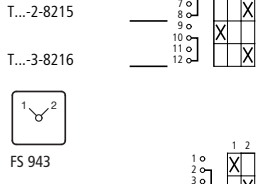
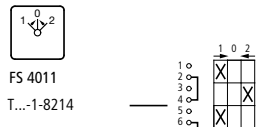
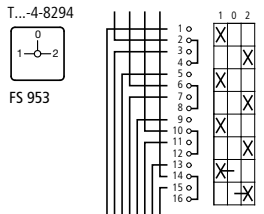
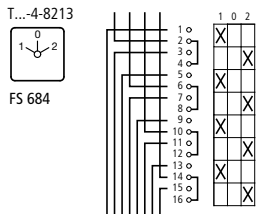
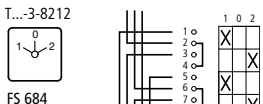
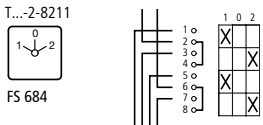
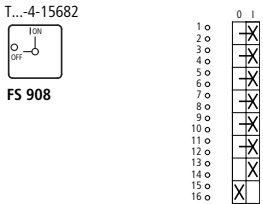
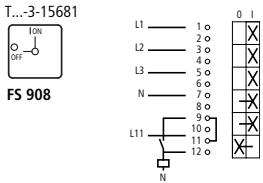
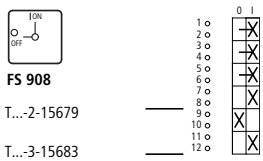
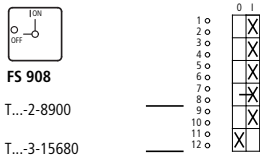
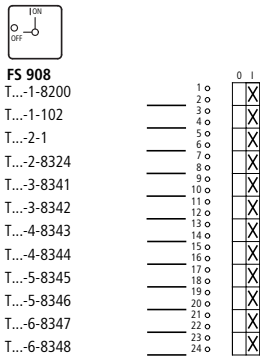

02/13 IL03801020Z