

## FEATURES

- Low Supply Current **300 $\mu$ A**
- 0.2 $\mu$ A Supply Current in SHUTDOWN
- ESD Protection  $\pm 10$ kV
- Operates From a Single 3.3V Supply
- Uses Small Capacitors 0.1 $\mu$ F
- Operates To 120k Baud
- Three-State Outputs are High Impedance When Off
- Output Overvoltage Does Not Force Current Back Into Supplies
- EIA/TIA-562 I/O Lines Can Be Forced to  $\pm 25$ V Without Damage
- Flowthrough Architecture

## APPLICATIONS

- Notebook Computers
- Palmtop Computers

## DESCRIPTION

The LTC1327 is an advanced low power, three-driver/five-receiver EIA/TIA-562 transceiver. In the no load condition, the supply current is only **300 $\mu$ A**. The charge pump only requires four 0.1 $\mu$ F capacitors.

In SHUTDOWN mode, the supply current is further reduced to 0.2 $\mu$ A. All EIA/TIA-562 outputs assume a high impedance state in SHUTDOWN and with the power off.

The LTC1327 is fully compliant with all data rate and overvoltage EIA/TIA-562 specifications. The transceiver can operate up to 120k Baud with a 1000pF/3k $\Omega$  load. Both driver outputs and receiver inputs can be forced to  $\pm 25$ V without damage, and can survive multiple  $\pm 10$ kV ESD strikes.

## TYPICAL APPLICATION

**3-Drivers/5-Receivers with SHUTDOWN**

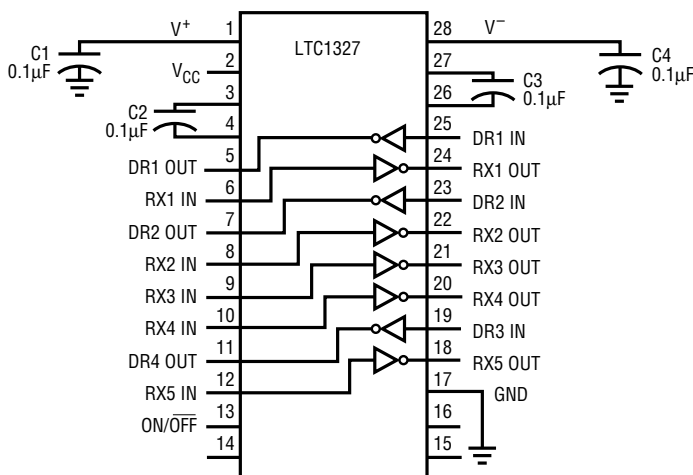

1327 TA01

**Supply Current vs Temperature**

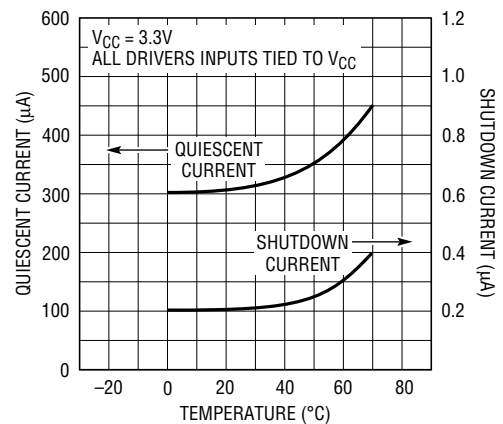

LTC1327 • TA02

**ABSOLUTE MAXIMUM RATINGS**

Supply Voltage ( $V_{CC}$ ) ..... 5V

Input Voltage

Driver .....  $-0.3V$  to  $(V_{CC} + 0.3V)$

Receiver .....  $-25V$  to  $25V$

On/Off Pin .....  $-0.3V$  to  $(V_{CC} + 0.3V)$

Output Voltage

Driver .....  $-25V$  to  $25V$

Receiver .....  $-0.3V$  to  $(V_{CC} + 0.3V)$

Short-Circuit Duration

$V^+$  ..... 30 sec

$V^-$  ..... 30 sec

Driver Output ..... Indefinite

Receiver Output ..... Indefinite

Operating Temperature Range

Commercial LTC1327C .....  $0^{\circ}C$  to  $70^{\circ}C$

Storage Temperature Range .....  $-65^{\circ}C$  to  $150^{\circ}C$

Lead Temperature (Soldering, 10 sec) .....  $300^{\circ}C$

**PACKAGE/ORDER INFORMATION**

TOP VIEW

G PACKAGE 28-LEAD SSOP      N PACKAGE 28-LEAD PLASTIC DIP

S PACKAGE 28-LEAD PLASTIC SOL

$T_{JMAX} = 125^{\circ}C, \theta_{JA} = 96^{\circ}C/W$  (G)

$T_{JMAX} = 125^{\circ}C, \theta_{JA} = 56^{\circ}C/W$  (N)

$T_{JMAX} = 125^{\circ}C, \theta_{JA} = 85^{\circ}C/W$  (S)

ORDER PART NUMBER	
LTC1327CG	
LTC1327CN	
LTC1327CS	

Consult factory for Industrial and Military grade parts.

**DC ELECTRICAL CHARACTERISTICS**  $V_{CC} = 3.3V, C1$  to  $C4 = 0.1\mu F$ , unless otherwise noted.

PARAMETER	CONDITIONS	MIN	TYP	MAX	UNITS
<b>Any Driver</b>					
Output Voltage Swing	Positive Negative (3k to GND)	● ●	3.7 -3.7	4.5 -4.5	V V
Logic Input Voltage Level	Input Low Level ( $V_{OUT} = \text{High}$ ) Input High Level ( $V_{OUT} = \text{Low}$ )	● ●	2	1.4 1.4	0.8 V
Logic Input Current	$V_{IN} = 3.3$ $V_{IN} = 0$	● ●		5 -5	$\mu A$ $\mu A$
Output Short-Circuit Current	$V_{OUT} = 0V$			$\pm 7$	mA
Output Leakage Current	SHUTDOWN (Note 3), $V_{OUT} = \pm 20V$			$\pm 10$ $\pm 500$	$\mu A$
<b>Any Receiver</b>					
Input Voltage Thresholds	Input Low Threshold Input High Threshold	● ●	0.8	1.3 1.7	2.4 V
Hysteresis		●	0.1	0.4	1 V
Input Resistance	$V_{IN} = \pm 10V$		3	5	7 k $\Omega$
Output Voltage	Output Low, $I_{OUT} = -1.6mA$ ( $V_{CC} = 3.3V$ ) Output High, $I_{OUT} = 160\mu A$ ( $V_{CC} = 3.3V$ )	● ●	3	0.2 3.2	0.4 V
Output Short-Circuit Current	Sinking Current, $V_{OUT} = V_{CC}$		-2	-10	mA
Output Leakage Current	SHUTDOWN (Note 3), $0 \leq V_{OUT} \leq V_{CC}$	●		1	10 $\mu A$

**DC ELECTRICAL CHARACTERISTICS**  $V_{CC} = 3.3V$ ,  $C1$  to  $C4 = 0.1\mu F$ , unless otherwise noted.

PARAMETER	CONDITIONS	MIN	TYP	MAX	UNITS
<b>Power Supply Generator</b>					
$V^+$ Output Voltage	$I_{OUT} = 0mA$		5.7		V
	$I_{OUT} = 5mA$		5.5		V
$V^-$ Output Voltage	$I_{OUT} = 0mA$		-5.3		V
	$I_{OUT} = -5mA$		-5.0		V
Supply Rise Time	SHUTDOWN to Turn-On		0.2		ms
<b>Power Supply</b>					
$V_{CC}$ Supply Current	No Load (Note 2)	●	0.3	0.5	mA
Supply Leakage Current ( $V_{CC}$ )	SHUTDOWN (Note 3)	●	0.2	10	$\mu A$
On/Off Threshold Low		●	1.4	0.8	V
On/Off Threshold High		●	2	1.4	V

**AC CHARACTERISTICS**

Slew Rate	$R_L = 3k, C_L = 51pF$		3	6	30	$V/\mu s$
	$R_L = 3k, C_L = 1000pF$			5		$V/\mu s$
Driver Propagation Delay (TTL to EIA/TIA-562)	$t_{HLD}$	●		2	3.5	$\mu s$
	$t_{LHD}$	●		2	3.5	$\mu s$
Receiver Propagation Delay (EIA/TIA-562 to TTL)	$t_{HLR}$	●		0.3	0.8	$\mu s$
	$t_{LHR}$	●		0.2	0.8	$\mu s$

The ● denotes specifications which apply over the operating temperature ( $0^\circ C \leq T_A \leq 70^\circ C$ ).

**Note 1:** Absolute Maximum Ratings are those values beyond which the life of the device may be impaired.

**Note 2:** Supply current is measured with driver and receiver output unloaded and driver inputs tied high.

**Note 3:** Supply current measurement in SHUTDOWN mode is performed with  $V_{ON/OFF} = 0V$ .

**TYPICAL PERFORMANCE CHARACTERISTICS**

**Driver Output Voltage vs Temperature**

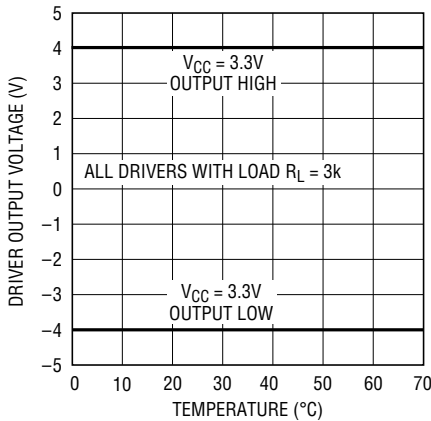

1327 G01

**Receiver Input Thresholds vs Temperature**

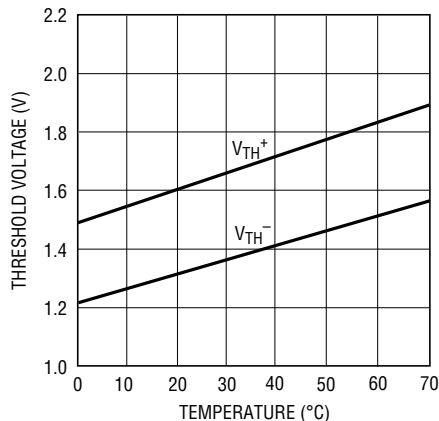

1327 G02

**Supply Current vs Data Rate**

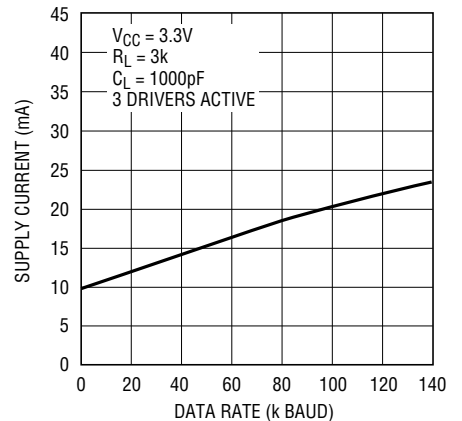

1327 G03

## TYPICAL PERFORMANCE CHARACTERISTICS

V<sub>CC</sub> Supply Current vs Data Rate

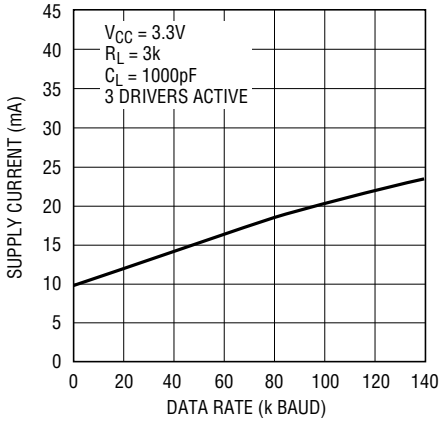

1327 G03

Driver Leakage in SHUTDOWN vs Temperature

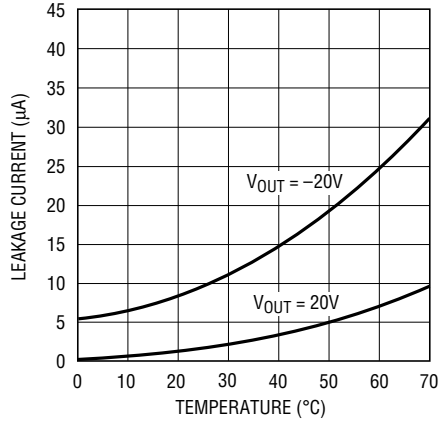

1327 G05

Driver Short-Circuit Current vs Supply Voltage

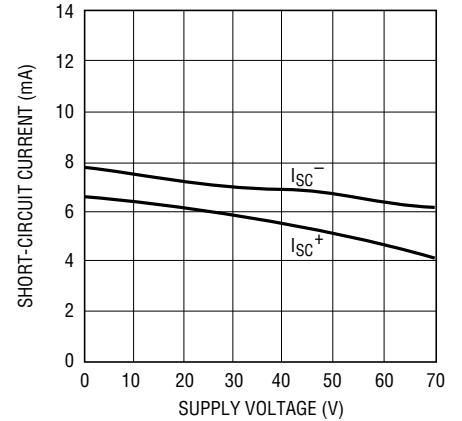

1327 G06

Receiver Short-Circuit Current vs Temperature

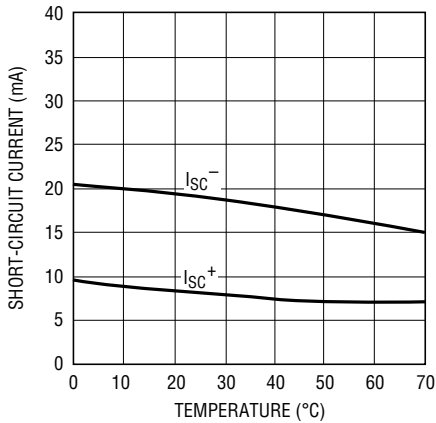

1327 G07

Driver Output Waveform

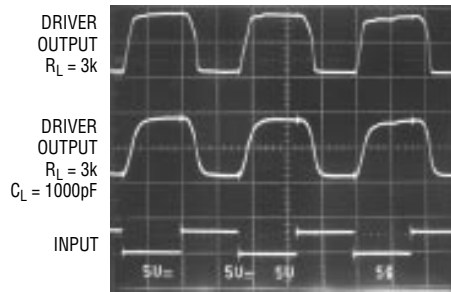

1327 G08

Receiver Output Waveform

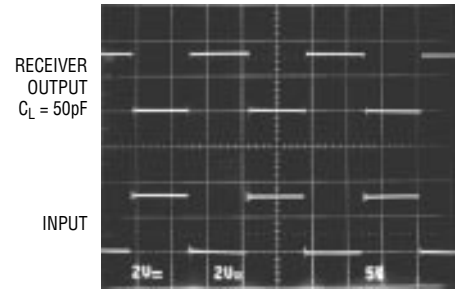

1327 G09

## PIN FUNCTIONS

**V<sub>CC</sub>**: 3.3V Input Supply Pin. Supply current 0.2µA in the SHUTDOWN mode. This pin should be decoupled with a 0.1µF ceramic capacitor.

**GND**: Ground Pin.

**ON/OFF**: TTL/CMOS Compatible Shutdown Pin. A logic low puts the device in SHUTDOWN mode which reduces the supply current to 0.2µA and places all drivers and receivers in high impedance state. This pin cannot float.

**V<sup>+</sup>**: Positive Supply Output (EIA/TIA-562 Drivers).  $V^+ \cong 2V_{CC} - 1V$ . This pin requires an external capacitor

$C = 0.1\mu F$  for charge storage. The capacitor may be tied to ground or 3.3V. With multiple devices, the V<sup>+</sup> and V<sup>-</sup> pins may be paralleled into common capacitors. For large numbers of devices, increasing the size of the shared common storage capacitors is recommended to reduce ripple.

**V<sup>-</sup>**: Negative Supply Output (EIA/TIA-562 Drivers).  $V^- \cong -(2V_{CC} - 1.3)$ . This pin requires an external capacitor  $C = 0.1\mu F$  for a charge storage.

## PIN FUNCTIONS

**C1<sup>+</sup>, C1<sup>-</sup>, C2<sup>+</sup>, C2<sup>-</sup>:** Commutating Capacitor Inputs. These pins require two external capacitors  $C = 0.1\mu\text{F}$ . One from C1<sup>+</sup> to C1<sup>-</sup>, and another from C2<sup>+</sup> to C2<sup>-</sup>. To maintain charge pump efficiency, the capacitor's effective series resistance should be less than  $20\Omega$ .

**DR IN:** EIA/TIA-562 Driver Input Pins. Inputs are TTL/CMOS compatible. Inputs should not be allowed to float. Tie unused inputs to  $V_{CC}$ .

**DR OUT:** Driver Outputs at EIA/TIA-562 Voltage Levels. Outputs are in a high impedance state when in SHUT-

DOWN mode or  $V_{CC} = 0\text{V}$ . The driver outputs are protected against ESD to  $\pm 10\text{kV}$  for human body model discharges.

**RX IN:** Receiver Inputs. These pins can be forced to  $\pm 25\text{V}$  without damage. The receiver inputs are protected against ESD to  $\pm 10\text{kV}$  for human body model discharges. Each receiver provides  $0.4\text{V}$  of hysteresis for noise immunity.

**RX OUT:** Receiver Outputs With TTL/CMOS Voltage Levels. Outputs are in a high impedance state when in SHUT-DOWN mode to allow data line sharing.

## TEST CIRCUITS

ESD Test Circuit

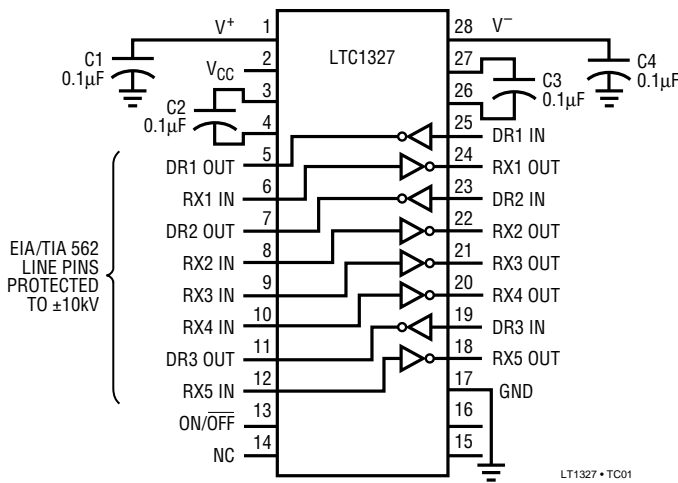

Driver Timing Test Load

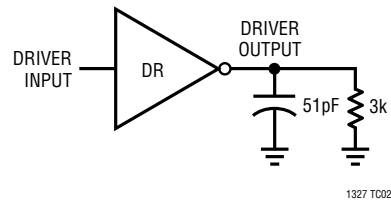

Receiver Timing Test Load

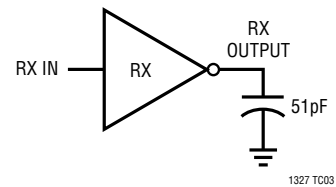

## SWITCHING TIME WAVEFORMS

Driver Propagation Delay Timing

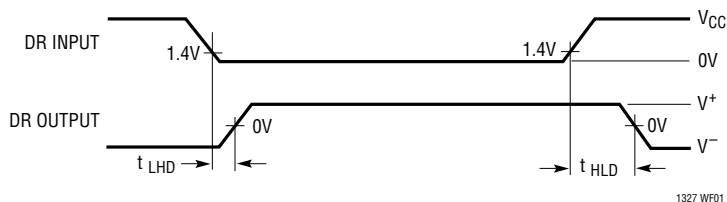

Receiver Propagation Delay Timing

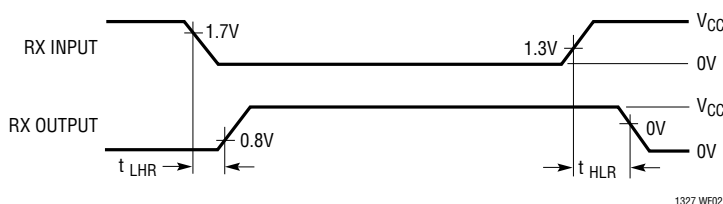

## APPLICATIONS INFORMATION

The LTC1327 is compatible with RS232 parts. This table shows some devices and the receiver input thresholds.

MANUFACTURER	PART NUMBER	COMPATIBLE	INPUT LOW THRESHOLD (V <sub>IL</sub> )			INPUT HIGH THRESHOLD (V <sub>IH</sub> )		
			MIN	TYP	MAX	MIN	TYP	MAX
Linear Technology	LT1080	√	0.8	1.3	–	–	1.7	2.4
	LT1137A	√	0.8	1.3	–	–	1.7	2.4
	LT1330	√	0.8	1.3	–	–	1.7	2.4
	LT1281	√	0.8	1.3	–	–	1.7	2.4
	All Others	√						
Texas Instruments	SN75189	√	0.65	1	1.25	0.9	1.3	1.6
	SN75189A	√	0.65	1	1.25	1.55	1.9	2.25
	MAX232	√	0.8	1.2	–	–	1.7	2.4
	SN75C185	√	0.65	1	1.25	1.6	2.1	2.55
Maxim	MAX232A	√	0.8	1.3	–	–	1.8	2.4
	MAX241	√	0.6	1.2	–	–	1.5	2.4
Sipex	SP232	√	0.8	1.2	–	–	1.7	2.4
	SP301	√	0.75	–	1.35	1.75	2.5	
Motorola	MC1489	√	0.75	–	1.25	1	–	1.5
	MC1489A	√	0.75	0.8	1.25	1.75	1.95	2.25
National	DS1489	√	0.75	1	1.25	1	1.25	1.5
	DS14C89A	√	0.5	–	1.9	1.3	–	2.7

**PACKAGE DESCRIPTION** Dimensions in inches (millimeters) unless otherwise noted.

**G Package  
28-Lead SSOP**

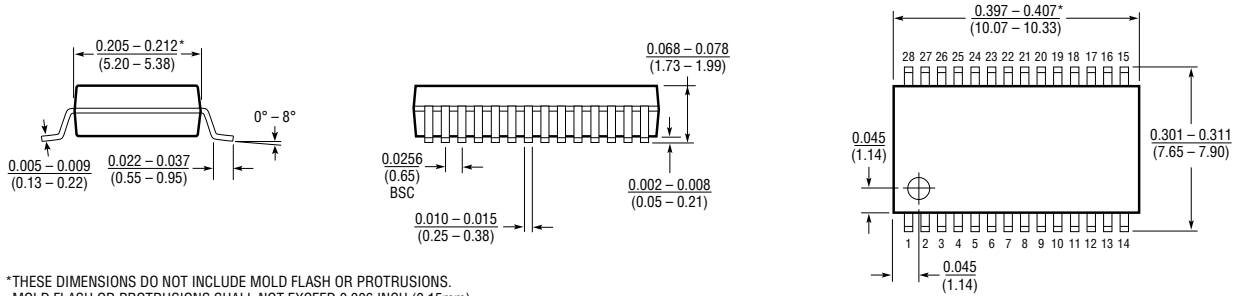

\*THESE DIMENSIONS DO NOT INCLUDE MOLD FLASH OR PROTRUSIONS.  
MOLD FLASH OR PROTRUSIONS SHALL NOT EXCEED 0.006 INCH (0.15mm).

**N Package  
28-Lead Plastic DIP**

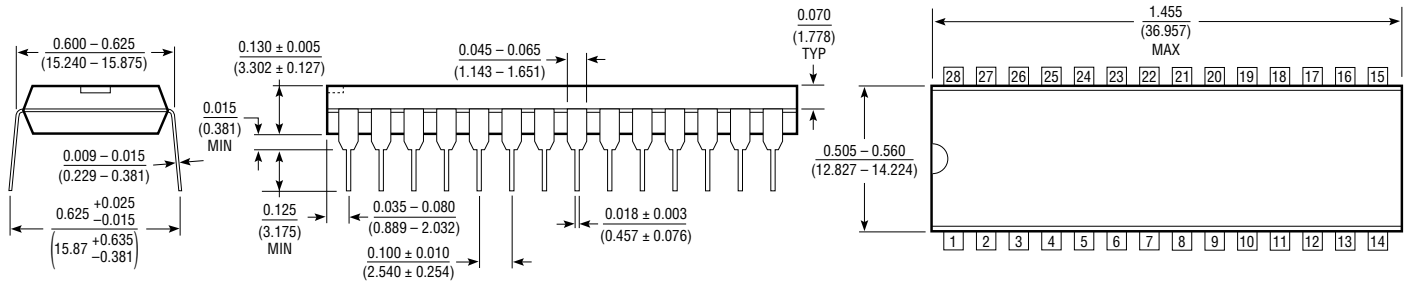

**S Package  
28-Lead Plastic SOL**

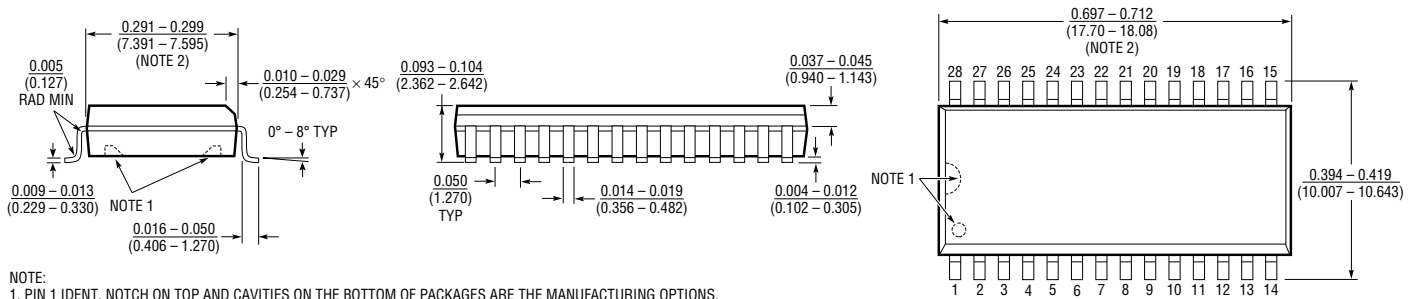

NOTE:  
1. PIN 1 IDENT, NOTCH ON TOP AND CAVITIES ON THE BOTTOM OF PACKAGES ARE THE MANUFACTURING OPTIONS.  
THE PART MAY BE SUPPLIED WITH OR WITHOUT ANY OF THE OPTIONS.  
2. THESE DIMENSIONS DO NOT INCLUDE MOLD FLASH OR PROTRUSIONS.  
MOLD FLASH OR PROTRUSIONS SHALL NOT EXCEED 0.006 INCH (0.15mm).

## U.S. Area Sales Offices

### NORTHEAST REGION

**Linear Technology Corporation**  
One Oxford Valley  
2300 E. Lincoln Hwy., Suite 306  
Langhorne, PA 19047  
Phone: (215) 757-8578  
FAX: (215) 757-5631

### Linear Technology Corporation

266 Lowell St., Suite B-8  
Wilmington, MA 01887  
Phone: (508) 658-3881  
FAX: (508) 658-2701

### SOUTHEAST REGION

**Linear Technology Corporation**  
17060 Dallas Parkway  
Suite 208  
Dallas, TX 75248  
Phone: (214) 733-3071  
FAX: (214) 380-5138

### CENTRAL REGION

**Linear Technology Corporation**  
Chesapeake Square  
229 Mitchell Court, Suite A-25  
Addison, IL 60101  
Phone: (708) 620-6910  
FAX: (708) 620-6977

### SOUTHWEST REGION

**Linear Technology Corporation**  
22141 Ventura Blvd.  
Suite 206  
Woodland Hills, CA 91364  
Phone: (818) 703-0835  
FAX: (818) 703-0517

### NORTHWEST REGION

**Linear Technology Corporation**  
782 Sycamore Dr.  
Milpitas, CA 95035  
Phone: (408) 428-2050  
FAX: (408) 432-6331

## International Sales Offices

### FRANCE

**Linear Technology S.A.R.L.**  
Immeuble "Le Quartz"  
58 Chemin de la Justice  
92290 Chatenay Malabry  
France  
Phone: 33-1-41079555  
FAX: 33-1-46314613

### GERMANY

**Linear Technolgy GMBH**  
Untere Hauptstr. 9  
D-85386 Eching  
Germany  
Phone: 49-89-3197410  
FAX: 49-89-3194821

### JAPAN

**Linear Technology KK**  
5F YZ Bldg.  
4-4-12 Iidabashi, Chiyoda-Ku  
Tokyo, 102 Japan  
Phone: 81-3-3237-7891  
FAX: 81-3-3237-8010

### KOREA

**Linear Technology Korea Branch**  
Namsong Building, #505  
Itaewon-Dong 260-199  
Yongsan-Ku, Seoul  
Korea  
Phone: 82-2-792-1617  
FAX: 82-2-792-1619

### SINGAPORE

**Linear Technology Pte. Ltd.**  
101 Boon Keng Road  
#02-15 Kallang Ind. Estates  
Singapore 1233  
Phone: 65-293-5322  
FAX: 65-292-0398

### TAIWAN

**Linear Technology Corporation**  
Rm. 801, No. 46, Sec. 2  
Chung Shan N. Rd.  
Taipei, Taiwan, R.O.C.  
Phone: 886-2-521-7575  
FAX: 886-2-562-2285

### UNITED KINGDOM

**Linear Technology (UK) Ltd.**  
The Coliseum, Riverside Way  
Camberley, Surrey GU15 3YL  
United Kingdom  
Phone: 44-276-677676  
FAX: 44-276-64851

## World Headquarters

**Linear Technology Corporation**  
1630 McCarthy Blvd.  
Milpitas, CA 95035-7487  
Phone: (408) 432-1900  
FAX: (408) 434-0507



# Mouser Electronics

Authorized Distributor

Click to View Pricing, Inventory, Delivery & Lifecycle Information:

[Analog Devices Inc.:](#)

[LTC1327CG#TRPBF](#) [LTC1327CSW#PBF](#) [LTC1327CG#PBF](#) [LTC1327CSW#TRPBF](#)