

Ausführung EM/ET 238 F/
type EM/ET 238 F

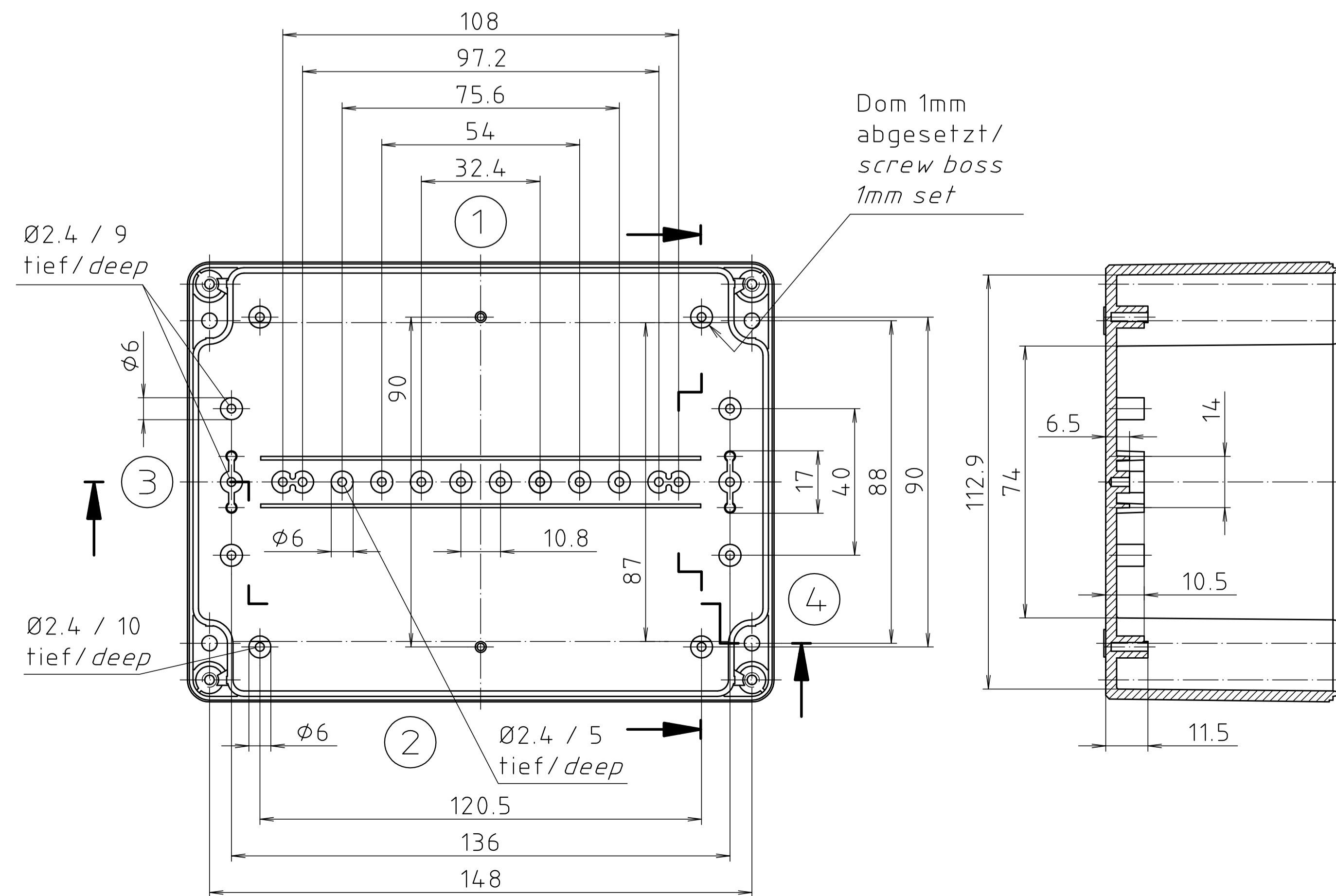

Maßstab/ Scale:	1:1	
Zeichnungs-Nr. / Drawing-No.:	1K 5145.048.02	
Artikel / Article:	EM/ET 238 EM/ET 238 F	
Katalogzeichnung / Catalogue drawing		
A.Nr. / Alt.-No.:	3633	
Datum / Date:	22.08.2002	
DISK:	2 501 005	
Datum / Date:	18.03.93 OK	

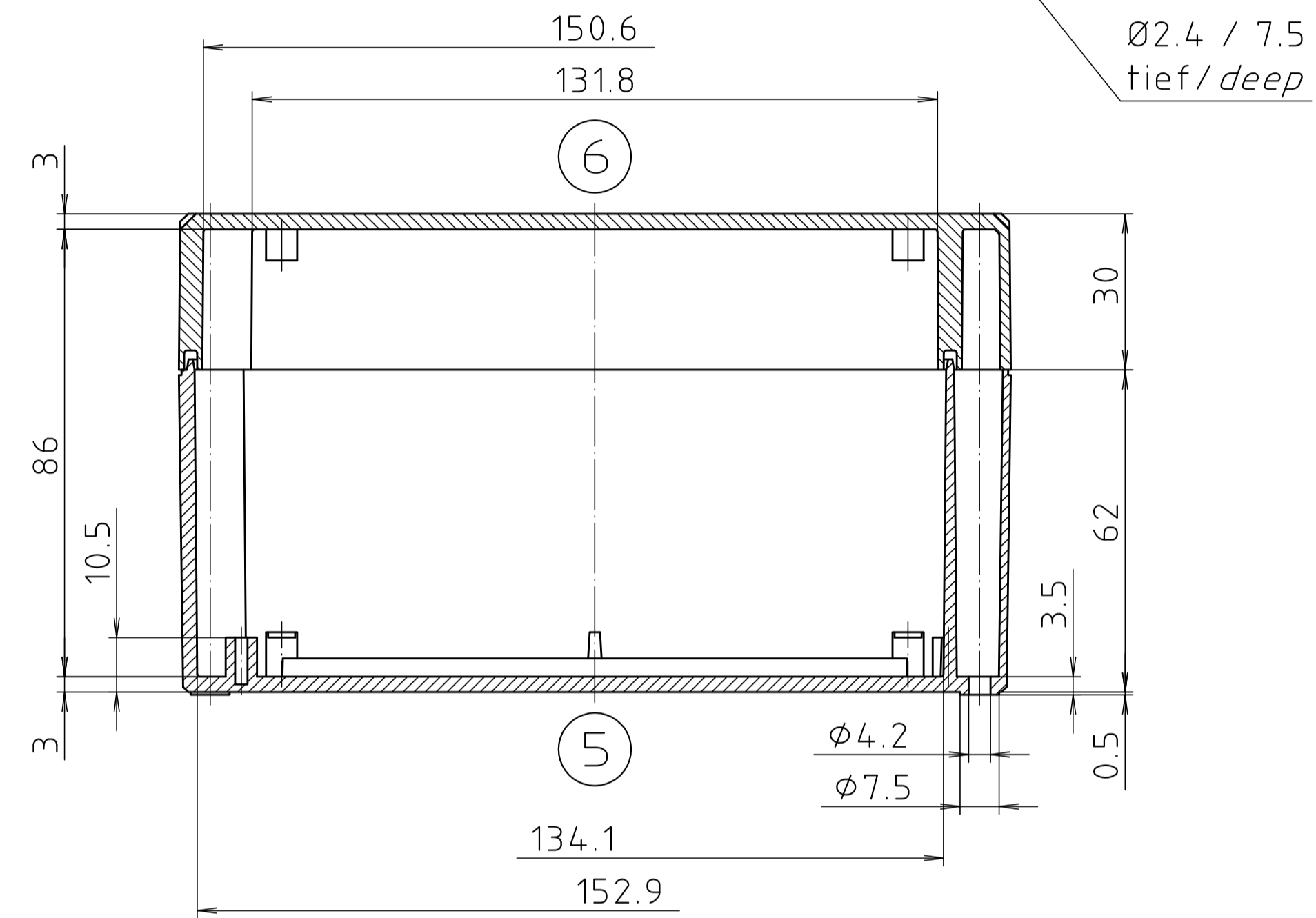
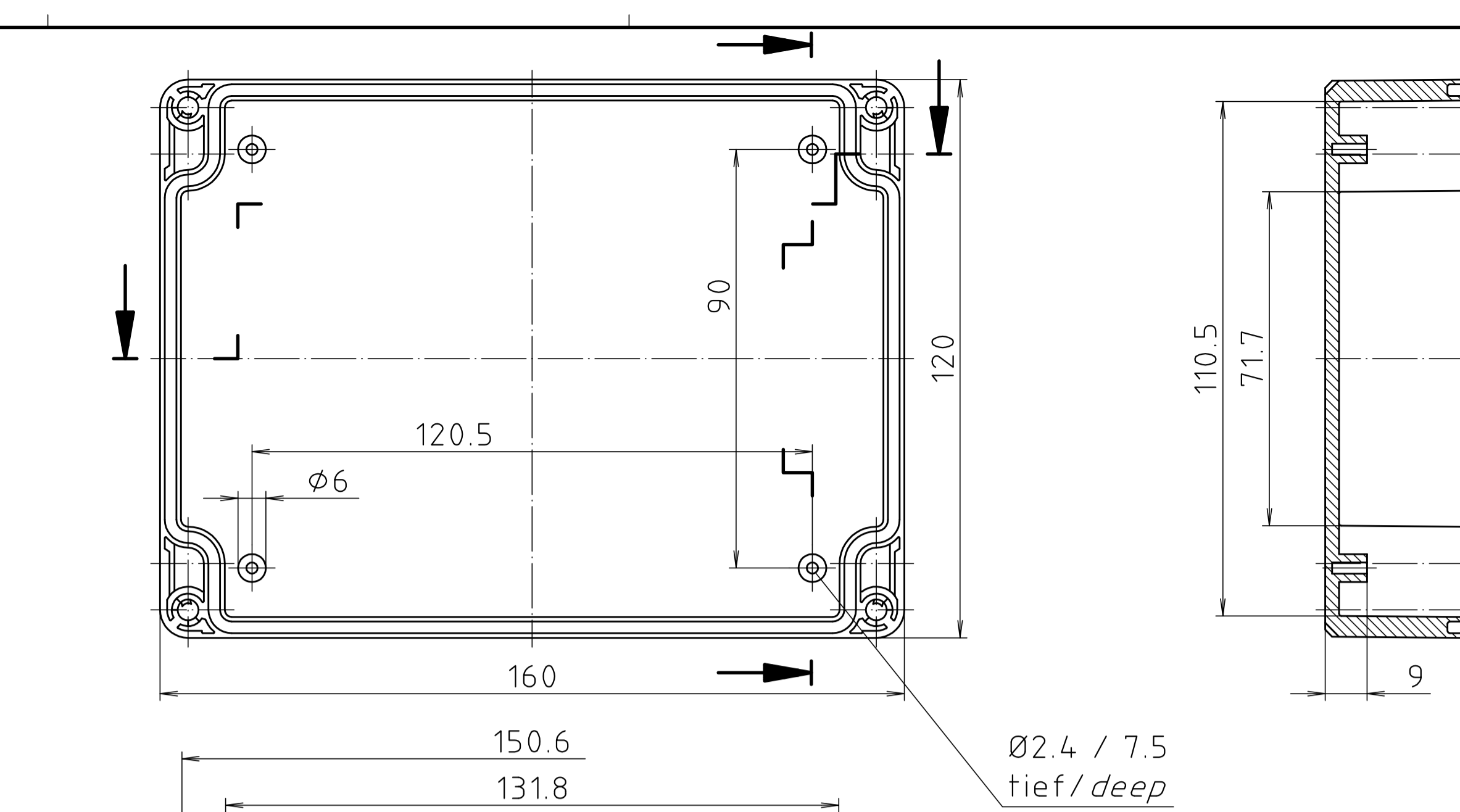
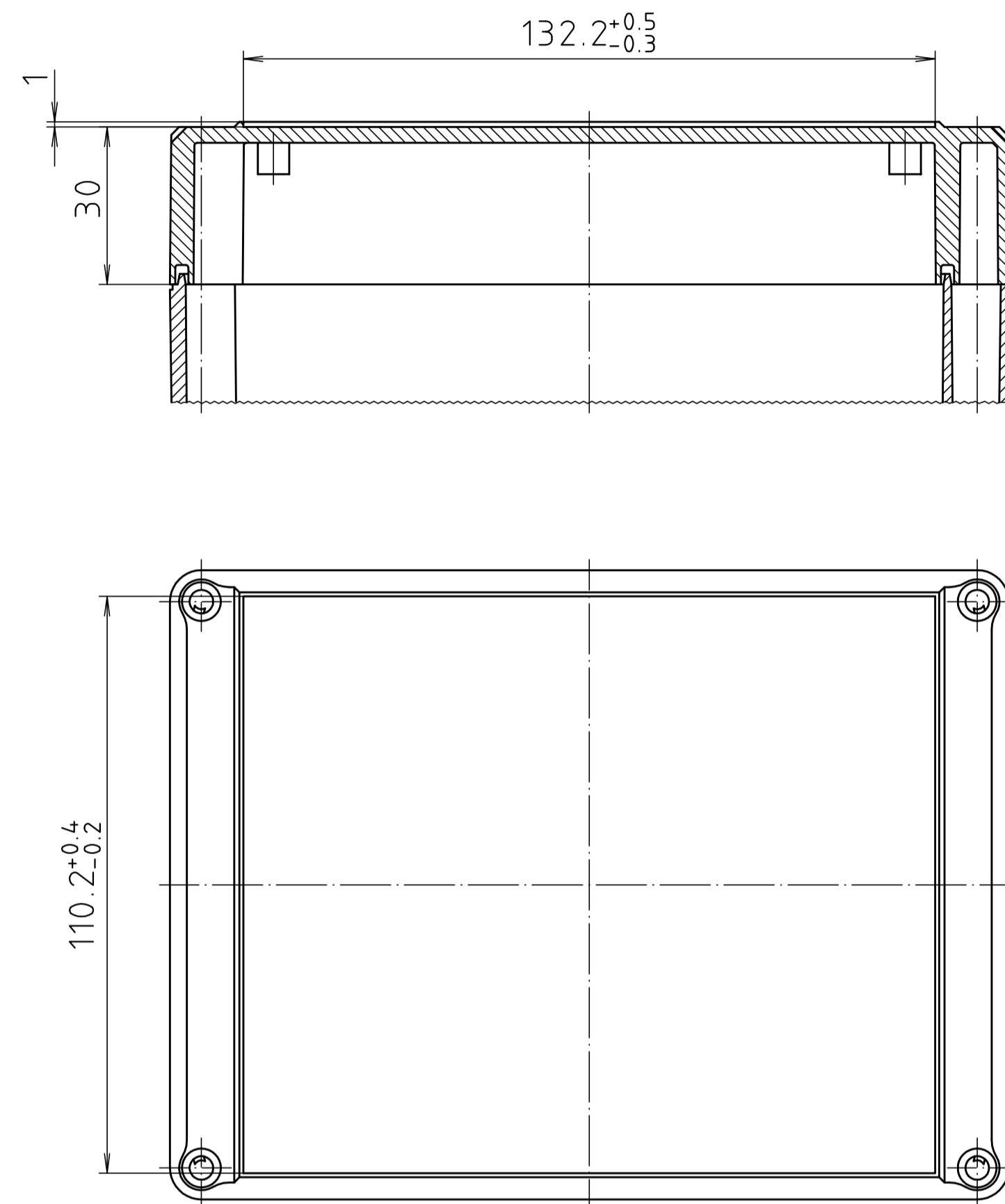

"Schutzvermerk nach DIN ISO 16016 beachten" - "Please pay attention to copyright note DIN ISO 16016"