

16-Bit, 16-Channel, 500 kSPS/1 MSPS, Easy Drive Multiplexed SAR ADC

FEATURES

- ▶ Easy Drive
 - ▶ Reduced analog input and reference drive requirements
 - ▶ On-chip reference buffer (WLCSP only)
 - ▶ Overvoltage protection up to 5 mA on each analog input
 - ▶ Long acquisition phase, $\geq 71.5\%$ (715 ns/1000 ns) of cycle time at 1 MSPS
- ▶ High performance
 - ▶ Sample rate: 500 kSPS (AD4695) or 1 MSPS (AD4696)
 - ▶ INL: ± 1.0 LSB maximum
 - ▶ Guaranteed 16-bit, no missing codes
 - ▶ SINAD: 93 dB typical, $f_{IN} = 1$ kHz
 - ▶ Oversampled dynamic range: 111.2 dB, OSR = 64
- ▶ Small footprint, high channel density
 - ▶ [32-lead 5 mm × 5 mm LFCSP](#)
 - ▶ [36-ball 2.96 mm × 2.96 mm WLCSP](#)
 - ▶ Easy Drive features support system level designs with fewer components
- ▶ Enhanced digital functionality
 - ▶ First conversion accurate, no latency or pipeline delay
 - ▶ Fast conversion time and dual-/quad-SDO modes allow low SPI clock rates
 - ▶ Customizable channel sequencer
 - ▶ On-chip oversampling and decimation
 - ▶ Threshold detection alerts
 - ▶ Offset and gain correction
 - ▶ Autonomous conversion (autocycle) mode
 - ▶ 1.14 V to 1.98 V logic SPI
- ▶ Low power
 - ▶ 8 mW at $f_S = 1$ MSPS and 4 mW at $f_S = 500$ kSPS
 - ▶ 4 μ W standby power dissipation with the internal LDO disabled
 - ▶ Internal LDO enables 3.15 V to 5.5 V, single analog supply operation
- ▶ Wide operating temperature range: -40°C to $+125^\circ\text{C}$

APPLICATIONS

- ▶ Photodiode monitoring
- ▶ Medical instrumentation
- ▶ Vital signs monitoring
- ▶ Electronic test and measurement
- ▶ Automated test equipment
- ▶ Instrumentation and process control
- ▶ Battery-powered equipment

Rev. A

DOCUMENT FEEDBACK

TECHNICAL SUPPORT

Information furnished by Analog Devices is believed to be accurate and reliable "as is". However, no responsibility is assumed by Analog Devices for its use, nor for any infringements of patents or other rights of third parties that may result from its use. Specifications subject to change without notice. No license is granted by implication or otherwise under any patent or patent rights of Analog Devices. Trademarks and registered trademarks are the property of their respective owners.

GENERAL DESCRIPTION

The AD4695/AD4696 are compact, high accuracy, low power, 16-channel, 16-bit, 500 kSPS/1 MSPS, multiplexed input precision, successive approximation register (SAR) analog-to-digital converters (ADCs) with Easy Drive features and extensive digital functionality.

The AD4695/AD4696 are optimal for use in space constrained, multichannel, precision data acquisition systems and monitoring circuits. The AD4695/AD4696 feature a true 16-bit SAR ADC core with no missing codes, a 16-channel, low crosstalk multiplexer, a flexible channel sequencer, overvoltage protection clamp circuits on each analog input, on-chip oversampling and decimation, threshold detection and alert indicators, and an autonomous conversion (autocycle) mode.

The AD4695/AD4696 Easy Drive features relax the drive requirements of the analog front end (AFE) and reference circuitry. Analog input high-Z mode and reference input high-Z mode simplify system designs, reduce component count, and increase channel density by removing the need for dedicated high speed ADC drivers and reference buffers. The WLCSP option of the AD4695/AD4696 includes an internal reference buffer, which provides a true, buffered reference input.

Input overvoltage protection clamps on each analog input protect the AD4695/AD4696 from overvoltage events and prevent overvoltage events on one channel from degrading performance on other channels (see [Figure 27](#)).

Advanced digital functionality makes the AD4695/AD4696 compatible with a variety of low power digital hosts. The low serial peripheral interface (SPI) clock rate requirements, on-chip customizable channel sequencers, and oversampling and decimation reduce the burden on the digital host system. Autocycle mode and threshold detection features enable low power, interrupt driven firmware design by performing conversions autonomously and generating alerts based on channel specific threshold limits.

The AD4695/AD4696 are available in a [5 mm × 5 mm 32-lead lead frame chip scale package \(LFCSP\)](#) and a [2.96 mm × 2.96 mm 36-ball wafer level chip scale package \(WLCSP\)](#) with operation specified from -40°C to $+125^\circ\text{C}$.

TABLE OF CONTENTS

Features.....	1	Channel Sequencing Modes.....	41
Applications.....	1	Digital Interface.....	46
General Description.....	1	Register Configuration Mode.....	46
Functional Block Diagram.....	5	Conversion Mode.....	53
Specifications.....	6	Autocycle Mode.....	60
Timing Specifications.....	11	General-Purpose Pins.....	62
Absolute Maximum Ratings.....	13	Device Reset.....	63
Thermal Resistance.....	13	Applications Information.....	66
Electrostatic Discharge (ESD) Ratings.....	13	Analog Front-End Design.....	67
ESD Caution.....	13	Analog Input Overvoltage Protection.....	70
Pin Configuration and Function Descriptions.....	14	Reference Circuitry Design.....	70
Typical Performance Characteristics.....	17	Optimizing Reference Buffer Startup.....	72
Terminology.....	27	Converting Between Codes and Volts.....	73
Theory of Operation.....	28	Oversampling for Noise Reduction.....	73
Overview.....	28	Digital Interface Operation.....	73
Converter Operation.....	28	Device Configuration Recommendations.....	80
Transfer Function.....	30	Effective Channel Sample Rate.....	81
Analog Inputs.....	32	Layout Guidelines.....	83
Input Overvoltage Protection Clamps.....	35	Evaluating AD4695/AD4696 Performance.....	84
Temperature Sensor.....	36	Register Information.....	85
Voltage Reference Input.....	36	Register Overview.....	85
Power Supplies.....	37	Register Details.....	86
Oversampling and Decimation.....	38	Outline Dimensions.....	106
Offset and Gain Correction.....	39	Ordering Guide	106
Threshold Detection and Alert Indicators.....	39	Evaluation Boards.....	107
Busy Indicator.....	41		

REVISION HISTORY

5/2022—Rev. 0 to Rev. A

Added 36-Ball WLCSP.....	1
Changed Master to Host and 0x0xx to 0x00xx Throughout.....	1
Changes to Features Section.....	1
Changes to General Description Section.....	1
Changes to Figure 1.....	5
Changes to Specifications Section and Table 1.....	6
Added Note 6 and Note 7, Table 1; Renumbered Sequentially.....	6
Changes to Timing Specifications Section.....	11
Changes to Reference Inputs Parameter, Table 3.....	13
Changes to Thermal Resistance Section and Table 4.....	13
Added Table 6, Renumbered Sequentially.....	13
Changes to Table 7.....	14
Added Figure 3 and Table 8; Renumbered Sequentially	15
Changes to Typical Performance Characteristics Section.....	17
Changes to Overview Section.....	28
Changes to Figure 68 Caption to Figure 70 Caption.....	33
Changes to Analog Input High-Z Mode Section.....	33
Changes to Overvoltage Reduced Current Mode Section.....	35
Changes to Temperature Sensor Section.....	36

TABLE OF CONTENTS

Changes to Voltage Reference Input Section.....	36
Changes to Reference Input High-Z Mode Section.....	36
Added Internal Reference Buffer Section.....	37
Changes to Power Supplies Section.....	37
Changes to Internal LDO Section.....	38
Changes to Oversampling and Decimation Section.....	38
Changes to Offset and Gain Correction Section and Table 14.....	39
Changes to Threshold Detection and Alert Indicators Section.....	39
Changes to Alert Indicator Registers Section.....	39
Changed Alert Indicator on BSY_ALT_GP0 Section to Alert Indicator on General-Purpose Pins Section....	40
Changes to Alert Indicator on General-Purpose Pins Section.....	40
Changes to Busy Indicator Section.....	41
Changes to Busy Indicator on Serial Data Outputs Section.....	41
Changed Busy Indicator on BSY_ALT_GP0 Section to Busy Indicator on General-Purpose Pins Section...	41
Changes to Busy Indicator on General-Purpose Pins Section.....	41
Changes to Channel Sequencing Modes Section.....	41
Moved Table 15.....	42
Changes to Standard Sequencer Section.....	42
Changes to Advanced Sequencer Section.....	42
Change to Two-Cycle Command Mode Section.....	43
Changes to Single-Cycle Command Mode Section.....	43
Changes to Figure 79 and Figure 80.....	45
Changes to Digital Interface Section.....	46
Changes to Multibyte Register Access Section.....	47
Changes to Streaming Mode Section.....	48
Changes to Single Instruction Mode Section.....	48
Changes to Checksum Protection Section.....	50
Changes to Conversion Mode Section.....	53
Changes to Serial Data Output Modes Section, Table 19, and Table 20.....	54
Added Table 23.....	55
Changes to Conversion Mode Timing Diagrams Section.....	55
Added Figure 98 and Figure 99.....	59
Changes to Autocycle Mode Section.....	60
Changes to General-Purpose Pins Section and Table 25.....	62
Changes to GPIO Section.....	63
Change to Device Reset Section.....	63
Changes to Figure 112.....	66
Changes to External RC Filter Section.....	67
Changes to Guidelines for Driver Amplifier Selection Section and Table 26 Title.....	69
Changes to Analog Input Overvoltage Protection Section	70
Changes to Reference Circuitry Design Section.....	70
Changes to Reference Circuit Design for Driving REF Input Section.....	70
Added Reference Circuit Design for Internal Reference Buffer Section.....	72
Added Optimizing Reference Buffer Startup Section.....	72
Added Reference Buffer Startup with Bypass Option Section.....	72
Added Reference Buffer Startup with Boost Mode Section.....	73
Changes to SPI Peripheral Connections Section, Figure 118, and Figure 119.....	74
Added Figure 120.....	75
Changes to SPI Peripheral Synchronization in Conversion Mode Section.....	75

TABLE OF CONTENTS

Changes to Figure 121 and Figure 122.....	76
Changes to Figure 123 and Figure 124.....	77
Added Figure 125.....	78
Changes to SPI Peripheral Synchronization in Autocycle Mode Section.....	78
Changes to Conversion Mode SPI Clock Frequency Requirements Section and Table 28.....	79
Changes to Device Configuration Recommendations Section.....	80
Changes to Effective Channel Sample Rate Section.....	81
Changes to Layout Guidelines Section.....	83
Changes to Reference Control Register Figure and Table 49.....	96
Changes to GPIO Enable Register Figure and Table 53.....	99
Changes to General-Purpose Pin Function Control Register Figure and Table 54.....	100
Changes to Table 55.....	101
Updated Outline Dimensions.....	106
Changes to Ordering Guide.....	106
Added Evaluation Boards.....	107

12/2020—Revision 0: Initial Version

FUNCTIONAL BLOCK DIAGRAM

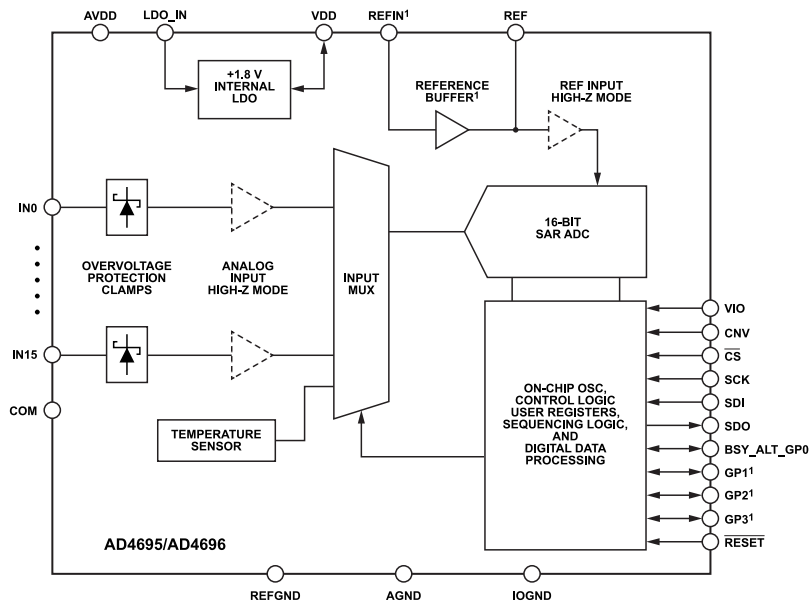

¹REFERENCE BUFFER AND GP1, GP2, GP3 PINS ONLY AVAILABLE ON THE WLCSP OPTION.

001

Figure 1.

SPECIFICATIONS

AVDD = 3.15 V to 5.5 V, LDO_IN = 2.4 V to 5.5 V with internal LDO enabled, LDO_IN = AGND with internal low dropout (LDO) disabled, VDD = 1.71 V to 1.89 V with internal LDO disabled, VIO = 1.14 V to 1.98 V, AGND = REFGND = IOGND = 0 V, reference voltage (V_{REF}) = 2.4 V to 5.1 V, REF = V_{REF} with internal reference buffer disabled, REFIN = V_{REF} with internal reference buffer enabled, reference buffer boost mode enabled, sample rate (f_S) = 1 MSPS for the AD4696, f_S = 500 kSPS for the AD4695, input frequency (f_{IN}) = 1 kHz, digital output load capacitance = 20 pF, autcycle mode disabled, analog input high-Z mode enabled, reference input high-Z mode enabled, busy indicator and alert indicator not enabled on general-purpose pins, no active overvoltage protection clamps, and T_A = -40°C to $+125^\circ\text{C}$, unless otherwise noted.

Table 1.

Parameter	Test Conditions/Comments	Min	Typ	Max	Unit
RESOLUTION		16			Bits
ANALOG INPUT ^{1, 2}					
Input Voltage Range	Positive ADC input voltage (IN+) – negative ADC input voltage (IN-)				
Unipolar Mode		0		$+V_{REF}$	V
Pseudobipolar Mode		$-V_{REF}/2$		$+V_{REF}/2$	V
Operating Input Voltage					
IN+ – REFGND	IN- = REFGND	0		$+V_{REF}$	V
	IN- = COM, odd numbered input	-0.1		$V_{REF} + 0.1$	V
IN- – REFGND	IN- = COM, odd numbered input				
	Unipolar mode	-0.1		$V_{REF} + 0.1$	V
	Pseudobipolar mode	$V_{REF}/2 - 0.1$	$V_{REF}/2$	$V_{REF}/2 + 0.1$	V
Common-Mode Rejection Ratio (CMRR)	f_{IN} = 250 kHz, IN- = COM, odd numbered input		69.5		dB
Analog Input Leakage Current ³			10		nA
SAMPLING DYNAMICS					
Sample Rate	Autocycle mode disabled				
AD4695				500	kSPS
AD4696				1	MSPS
Autocycle Sample Period	Autocycle mode enabled				
	AC_CYC = 0x0	8.5	10	11.5	μs
	AC_CYC = 0x1	17	20	23	μs
	AC_CYC = 0x2	34	40	46	μs
	AC_CYC = 0x3	68	80	92	μs
	AC_CYC = 0x4	85	100	115	μs
	AC_CYC = 0x5	170	200	230	μs
	AC_CYC = 0x6	340	400	460	μs
	AC_CYC = 0x7	680	800	920	μs
Aperture Delay			2		ns
Aperture Jitter			0.5		ps rms
DC ACCURACY					
No Missing Codes		16			Bits
Integral Nonlinearity Error (INL)	V_{REF} = 5 V, oversampling ratio (OSR) = 1 LFCSP, T_A = -40°C to $+125^\circ\text{C}$ WLCSP, T_A = 0°C to $+70^\circ\text{C}$ WLCSP, T_A = -40°C to $+125^\circ\text{C}$	-1	± 0.4	+1	LSB
		-2	± 0.4	+2	LSB
		-2.5	± 0.4	+2.5	LSB
Differential Nonlinearity Error (DNL)	V_{REF} = 5 V, OSR = 1	-0.6	± 0.3	+0.6	LSB
Transition Noise	V_{REF} = 5 V		0.5		LSB rms
Offset Error ⁴	V_{REF} = 5 V T_A = 25°C T_A = -40°C to $+125^\circ\text{C}$		± 0.03		mV
		-0.43		+0.43	mV

SPECIFICATIONS

Table 1.

Parameter	Test Conditions/Comments	Min	Typ	Max	Unit
Offset Error Match ⁴	$V_{REF} = 5\text{ V}$ $T_A = 25^\circ\text{C}$		± 0.025		mV
Gain Error ⁴	$T_A = -40^\circ\text{C to } +125^\circ\text{C}$ $V_{REF} = 5\text{ V}$ $T_A = 25^\circ\text{C}$	-0.23		+0.23	mV
Gain Error Match ⁴	$T_A = -40^\circ\text{C to } +125^\circ\text{C}$ $V_{REF} = 5\text{ V}$ $T_A = 25^\circ\text{C}$	-0.025	± 0.001	+0.025	%FS ⁵
	$T_A = -40^\circ\text{C to } +125^\circ\text{C}$ $V_{REF} = 5\text{ V}$ $T_A = 25^\circ\text{C}$	-0.012	± 0.002	+0.012	%FS
AC PERFORMANCE					
Dynamic Range	$V_{REF} = 5\text{ V}$ OSR = 1		93.4		dB
	OSR = 4		99.3		dB
	OSR = 16		105.3		dB
	OSR = 64		111.2		dB
Input RMS Noise	OSR = 1		37.8		$\mu\text{V rms}$
	OSR = 4		19.2		$\mu\text{V rms}$
	OSR = 16		9.6		$\mu\text{V rms}$
	OSR = 64		4.9		$\mu\text{V rms}$
1/f Noise	Bandwidth = 0.1 Hz to 10 Hz		5		$\mu\text{V p-p}$
Signal-to-Noise Ratio (SNR)	$V_{REF} = 5\text{ V}, f_{IN} = 1\text{ kHz}$	91.25	93		dB
	$V_{REF} = 4.096\text{ V}, f_{IN} = 1\text{ kHz}$		91.3		dB
	$V_{REF} = 2.5\text{ V}, f_{IN} = 1\text{ kHz}$		87		dB
Total Harmonic Distortion (THD)	$V_{REF} = 5\text{ V}, f_{IN} = 1\text{ kHz}$		-117		dB
	$V_{REF} = 4.096\text{ V}, f_{IN} = 1\text{ kHz}$		-117.5		dB
	$V_{REF} = 2.5\text{ V}, f_{IN} = 1\text{ kHz}$		-119		dB
Signal-to-Noise-and-Distortion (SINAD)					
LFCSP	$V_{REF} = 5\text{ V}, f_{IN} = 1\text{ kHz}$	91.1	93		dB
	$V_{REF} = 4.096\text{ V}, f_{IN} = 1\text{ kHz}$		91.3		dB
	$V_{REF} = 2.5\text{ V}, f_{IN} = 1\text{ kHz}$		87		dB
WLCSP	$V_{REF} = 5\text{ V}, f_{IN} = 1\text{ kHz}$	89	93		dB
Spurious-Free Dynamic Range (SFDR)	$V_{REF} = 5\text{ V}$		121		dB
Channel to Channel Isolation	$f_{IN} = 100\text{ kHz}$ LFCSP option		-123		dB
	WLCSP option		-120		dB
Channel to Channel Memory	$f_{IN} = 100\text{ kHz}, f_S = 1\text{ MSPS}$		-100		dB
	$f_{IN} = 100\text{ kHz}, f_S = 500\text{ kSPS}$		-110		dB
-3 dB Input Bandwidth			11.7		MHz
REFERENCE INPUT ⁶					
V_{REF} Range	REF input, internal reference buffer disabled	2.4		AVDD + 0.25	V
	REFIN input, internal reference buffer disabled		REF		
	REFIN input, internal reference buffer enabled	2.4		AVDD - 0.3	V
REF Leakage Current	$V_{REF} = 5\text{ V}$				
LFCSP	No active overvoltage protection clamps		165		nA
	All clamps active, overvoltage reduced, current mode disabled		375		μA
	All clamps active, overvoltage reduced, current mode enabled		8		μA
WLCSP	Internal reference buffer disabled		165		nA

SPECIFICATIONS

Table 1.

Parameter	Test Conditions/Comments	Min	Typ	Max	Unit
REF Average Input Current	$V_{REF} = AVDD = 5\text{ V}$, internal reference buffer disabled				
Reference High-Z Mode Disabled	$f_S = 10\text{ kSPS}$, unipolar mode		3.3		μA
	$f_S = 500\text{ kSPS}$, unipolar mode		160		μA
	$f_S = 1\text{ MSPS}$, unipolar mode		320		μA
	$f_S = 10\text{ kSPS}$, pseudobipolar mode		4.0		μA
	$f_S = 500\text{ kSPS}$, pseudobipolar mode		195		μA
	$f_S = 1\text{ MSPS}$, pseudobipolar mode		390		μA
Reference High-Z Mode Enabled	$f_S = 10\text{ kSPS}$, unipolar mode		0.3		μA
	$f_S = 500\text{ kSPS}$, unipolar mode		6		μA
	$f_S = 1\text{ MSPS}$, unipolar mode		12		μA
	$f_S = 10\text{ kSPS}$, pseudobipolar mode		0.4		μA
	$f_S = 500\text{ kSPS}$, pseudobipolar mode		11		μA
	$f_S = 1\text{ MSPS}$, pseudobipolar mode		22		μA
REFIN Current	$V_{REF} = 5\text{ V}$				
Internal Reference Buffer Enabled	No active overvoltage protection clamps		16		nA
	All clamps active, overvoltage reduced, current mode disabled		200		μA
	All clamps active, overvoltage reduced, current mode enabled		4.5		μA
REFIN Input Capacitance	WLCSF, internal reference buffer enabled		50		pF
Internal Reference Buffer Output Current Limit	Reference buffer boost mode disabled		3.5		mA
	Reference buffer boost mode enabled		11		mA
Internal Reference Buffer Turn-On Time ⁷ (t_{REFBUF})	$V_{REF} = 5\text{ V}$				
Reference Buffer Boost Mode Disabled	REF decoupling capacitor ($C_{REF} = 1\text{ }\mu\text{F}$)		10		ms
	$C_{REF} = 10\text{ }\mu\text{F}$		80		ms
Reference Buffer Boost Mode Enabled	$C_{REF} = 1\text{ }\mu\text{F}$		1.2		ms
	$C_{REF} = 10\text{ }\mu\text{F}$		10		ms
TEMPERATURE SENSOR					
Temperature Sensor Voltage	$T_A = 25^\circ\text{C}$		680		mV
	$T_A = 0^\circ\text{C}$		725		mV
Temperature Sensitivity	$T_A = -40^\circ\text{C}$ to $+125^\circ\text{C}$		-1.8		mV/ $^\circ\text{C}$
OVERVOLTAGE CLAMP					
External Series Resistance (R_{EXT}) ⁸	For stable clamp operation				
	Overvoltage reduced current mode disabled			2000	Ω
	Overvoltage reduced current mode enabled			1000	Ω
External Series Capacitance (C_{EXT}) ⁸	For stable clamp operation	500			pF
Clamp Input Current	For each active clamp			5	mA
Clamp Activation Voltage				$V_{REF} + 0.55$	V
Clamp Deactivation Voltage		$V_{REF} + 0.1$			V
Input Clamping Voltage	Clamp current = 5 mA		$V_{REF} + 0.2$		V
Activation Time			50		ns
Deactivation Time			100		ns
DIGITAL INPUTS					
Logic Levels					
Input Low Voltage (V_{IL})		-0.3		$+0.3 \times V_{IO}$	V
Input High Voltage (V_{IH})		$0.7 \times V_{IO}$		3.6	V
Input Current (I_L)		-1		+1	μA
Input Pin Capacitance			5		pF

SPECIFICATIONS

Table 1.

Parameter	Test Conditions/Comments	Min	Typ	Max	Unit
DIGITAL OUTPUTS					
Conversion Mode Data Format	Unipolar mode Pseudobipolar mode		Straight binary Twos complement		
Logic Levels					
Output Low Voltage (V_{OL})	Digital output current = +500 μ A			0.4	V
Output High Voltage (V_{OH})	Digital output current = -500 μ A	$V_{IO} - 0.3$			V
POWER REQUIREMENTS					
AVDD to AGND		3.15		5.5	V
LDO_IN to AGND	Internal LDO enabled	2.4		5.5	V
	Internal LDO disabled		0		V
VDD to AGND	Internal LDO disabled	1.71	1.8	1.89	V
VIO to IOGND		1.14		1.98	V
POWER SUPPLY CURRENT⁹					
Standby Current					
AVDD	AVDD = 5 V				
	Internal reference buffer disabled		160		nA
	Internal reference buffer enabled		460		μ A
LDO_IN	LDO_IN = 5 V				
	Internal LDO enabled		9		μ A
	Internal LDO disabled		0.3		μ A
VDD	VDD = 1.8 V, internal LDO disabled				
	Internal reference buffer disabled		1.5		μ A
	Internal reference buffer enabled		5		μ A
VIO	VIO = 1.8 V		250		nA
AVDD Current (Conversion Mode)	AVDD = 5 V				
	Internal Reference Buffer Disabled, Reference High-Z Mode Disabled, Analog Input High-Z Mode Disabled	$f_S = 10$ kSPS	680		nA
		$f_S = 500$ kSPS	26		μ A
		$f_S = 1$ MSPS	52		μ A
	Internal Reference Buffer Disabled, Reference High-Z Mode Enabled, Analog Input High-Z Mode Enabled	$f_S = 10$ kSPS	13		μ A
		$f_S = 500$ kSPS	0.64	0.73	mA
		$f_S = 1$ MSPS	1.28	1.46	mA
	Internal Reference Buffer Enabled, Reference High-Z Mode Enabled, Analog Input High-Z Mode Enabled	$f_S = 10$ kSPS, REFIN = 4.096 V	450		μ A
		$f_S = 500$ kSPS, REFIN = 4.096 V	1	1.14	mA
		$f_S = 1$ MSPS, REFIN = 4.096 V	1.5	1.78	mA
LDO_IN Current (Conversion Mode)	LDO_IN = 5 V, internal LDO enabled				
	Reference High-Z Mode Disabled, Analog Input High-Z Mode Disabled	$f_S = 10$ kSPS	52		μ A
		$f_S = 500$ kSPS	2		mA
		$f_S = 1$ MSPS	4		mA
	Reference High-Z Mode Enabled, Analog Input High-Z Mode Enabled	$f_S = 10$ kSPS	64		μ A
		$f_S = 500$ kSPS	2.6	3.3	mA
		$f_S = 1$ MSPS	5.2	6.6	mA

SPECIFICATIONS

Table 1.

Parameter	Test Conditions/Comments	Min	Typ	Max	Unit
VDD Current (Conversion Mode)	VDD = 1.8 V, internal LDO disabled				
Reference High-Z Mode Disabled, Analog Input High-Z Mode Disabled	$f_S = 10$ kSPS		42		μ A
	$f_S = 500$ kSPS		2		mA
	$f_S = 1$ MSPS		4		mA
Reference High-Z Mode Enabled, Analog Input High-Z Mode Enabled	$f_S = 10$ kSPS		53		μ A
	$f_S = 500$ kSPS		2.5	3.2	mA
	$f_S = 1$ MSPS		5	6.4	mA
VIO Dynamic Current	VIO = 1.8 V				
Register Configuration Mode	Streaming mode, SCK frequency (f_{SCK}) = 50 MHz		125		μ A
Conversion Mode	Status bits enabled				
	$f_S = 10$ kSPS		3.5		μ A
	$f_S = 500$ kSPS		162		μ A
	$f_S = 1$ MSPS		325	360	μ A
POWER DISSIPATION ⁹	AVDD = 5 V, VIO = 1.8 V				
Standby Power Dissipation					
Internal LDO Disabled	VDD = 1.8 V, internal reference buffer disabled		4		μ W
	VDD = 1.8 V, internal reference buffer enabled		2.3		mW
Internal LDO Enabled	LDO_IN = 5 V, internal reference buffer disabled		46		μ W
	LDO_IN = 5 V, internal reference buffer enabled		2.3		mW
Power Dissipation, Internal LDO Disabled	LDO_IN = AGND, VDD = 1.8 V				
Internal Reference Buffer Disabled, Reference High-Z Mode Disabled, Analog Input High-Z Mode Disabled	$f_S = 10$ kSPS		85		μ W
	$f_S = 500$ kSPS		4		mW
	$f_S = 1$ MSPS		8		mW
Internal Reference Buffer Disabled, Reference High-Z Mode Enabled, Analog Input High-Z Mode Enabled	$f_S = 10$ kSPS		170		μ W
	$f_S = 500$ kSPS		8	9.8	mW
	$f_S = 1$ MSPS		16	19.5	mW
Internal Reference Buffer Enabled, Reference High-Z Mode Enabled, Analog Input High-Z Mode Enabled	$f_S = 10$ kSPS, REFIN = 4.096 V		2.4		mW
	$f_S = 500$ kSPS, REFIN = 4.096 V		9.8	11.8	mW
	$f_S = 1$ MSPS, REFIN = 4.096 V		17.1	21.1	mW
Power Dissipation, Internal LDO Enabled	LDO_IN = 5 V				
Internal Reference Buffer Disabled, Reference High-Z Mode Disabled, Analog Input High-Z Mode Disabled	$f_S = 10$ kSPS		270		μ W
	$f_S = 500$ kSPS		10.5		mW
	$f_S = 1$ MSPS		21		mW
Internal Reference Buffer Disabled, Reference High-Z Mode Enabled, Analog Input High-Z Mode Enabled	$f_S = 10$ kSPS		395		μ W
	$f_S = 500$ kSPS		16.5	20.5	mW
	$f_S = 1$ MSPS		33	41.0	mW
Internal Reference Buffer Enabled, Reference High-Z Mode Enabled, Analog Input High-Z Mode Enabled	$f_S = 10$ kSPS, REFIN = 4.096 V		2.6		mW

SPECIFICATIONS

Table 1.

Parameter	Test Conditions/Comments	Min	Typ	Max	Unit
Autocycle Mode Power Dissipation	$f_S = 500$ kSPS, REFIN = 4.096 V		18.3	22.5	mW
	$f_S = 1$ MSPS, REFIN = 4.096 V		34.1	42.6	mW
	LDO_IN = 5 V, internal LDO enabled, autocycle mode enabled				
	AC_CYC = 0x0		2.3		mW
	AC_CYC = 0x7		0.2		mW
TEMPERATURE RANGE					
Specified Performance	T_{MIN} to T_{MAX}	-40		+125	°C

- See the [Channel Configuration Options](#) section for a detailed description of unipolar mode, pseudobipolar mode, and the channel pin assignment options.
- IN+ and IN- represent the analog inputs connected to the positive and negative inputs of the AD4695/AD4696 ADC core via the internal multiplexer (see the [Multiplexer](#) section and [Channel Configuration Options](#) section).
- The analog input leakage current specification refers to the input current of the analog input pins during periods when the ADC is not performing conversions and the analog input voltage is already settled.
- Offset error and gain error specifications are taken with the offset and gain correction registers set to the default values, which correspond to no offset or gain correction. See the [Offset and Gain Correction](#) section for more information.
- %FS is the percentage of the ADC full scale (see the [Transfer Function](#) section for a definition of full scale).
- The REFIN pin and internal reference buffer are only available on the WLCSP models of the AD4695/AD4696. All specifications and conditions regarding REFIN or the internal reference buffer are therefore only relevant for WLCSP models.
- The reference buffer turn-on time specification refers to the amount of time between the reference buffer being enabled and the REF voltage settling to 0.01% accuracy (see the [Internal Reference Buffer](#) section).
- R_{EXT} and C_{EXT} refer to the resistor and capacitor, respectively, that make up the recommended external RC filters at the analog inputs (see the [External RC Filter](#) section).
- For the power supply current and power dissipation specifications where analog input high-Z mode is enabled, analog input high-Z mode is set to be enabled for all channels. The power consumption scales with the percentage of conversions performed with analog input high-Z mode enabled.

TIMING SPECIFICATIONS

AVDD = 3.15 V to 5.5 V, LDO_IN = 2.4 V to 5.5 V with internal LDO enabled, LDO_IN = AGND with internal LDO disabled, VDD = 1.71 V to 1.89 V with internal LDO disabled, VIO = 1.14 V to 1.98 V, AGND = REFGND = IOGND = 0 V, reference voltage (V_{REF}) = 2.4 V to 5.1 V, $f_S = 1$ MSPS for the AD4696, $f_S = 500$ kSPS for the AD4695, digital output load capacitance = 20 pF, autocycle mode disabled, no active overvoltage protection clamps, and $T_A = -40^\circ\text{C}$ to $+125^\circ\text{C}$, unless otherwise noted.

Table 2.

Parameter ¹	Symbol	Min	Typ	Max	Unit
Conversion Time	$t_{CONVERT}$		380	415	ns
Acquisition Time	t_{ACQ}				
Two-Cycle Command Mode, Standard Sequencer, or Advanced Sequencer Enabled					
$f_S = 1$ MSPS		715			ns
$f_S = 500$ kSPS		1715			ns
Single-Cycle Command Mode ² Enabled					
CNV Period (Time Between Conversions)	t_{CYC}				
$f_S = 1$ MSPS, Autocycle Mode Disabled		1000			ns
$f_S = 500$ kSPS, Autocycle Mode Disabled		2000			ns
Autocycle Mode Enabled					
AC_CYC = 0x0		8.5	10	11.5	μs
AC_CYC = 0x1		17	20	23	μs
AC_CYC = 0x2		34	40	46	μs
AC_CYC = 0x3		68	80	92	μs
AC_CYC = 0x4		85	100	115	μs

SPECIFICATIONS

Table 2.

Parameter ¹	Symbol	Min	Typ	Max	Unit
AC_CYC = 0x5		170	200	230	μs
AC_CYC = 0x6		340	400	460	μs
AC_CYC = 0x7		680	800	920	μs
CNV High Time	t _{CNVH}	10			ns
CNV Low Time	t _{CNVL}	80			ns
$\overline{\text{CS}}$ High Time	t _{CSBH}	5			ns
$\overline{\text{CS}}$ Low to Digital Interface Ready Delay	t _{EN}			15	ns
$\overline{\text{CS}}$ High to SDO High Impedance Delay	t _{CSBDIS}			15	ns
SCK Period	t _{SCK}				
Register Configuration Mode		40			ns
Conversion Mode		12.5			ns
SCK Low Time	t _{SCKL}				
Register Configuration Mode		16			ns
Conversion Mode		5			ns
SCK High Time	t _{SCKH}				
Register Configuration Mode		16			ns
Conversion Mode		5			ns
SDI Data Setup Time Prior to SCK Rising Edge	t _{SSDI}	2			ns
SDI Data Hold Time After SCK Rising Edge	t _{HSDI}	2			ns
SCK Falling Edge to Data Remains Valid Delay	t _{HSDO}	1.5			ns
SCK Falling Edge to Data Valid Delay	t _{DSDO}			10.5	ns
Last SCK Edge to CNV Rising Edge Delay	t _{SCKCNV}	80			ns
Last SCK Rising Edge to $\overline{\text{CS}}$ Rising Edge Delay	t _{SCKCSB}	1			ns
CNV Rising Edge to Busy Indicator Rising Edge (Busy Indicator Enabled on General-Purpose Pin)	t _{CNVBSY}			20	ns
CNV Rising Edge to Alert Indicator Transition (Alert Indicator Enabled on General-Purpose Pin)	t _{CNVALT}			425	ns
Busy Indicator Low Time, Autocycle Mode Enabled (Busy Indicator Enabled on General-Purpose Pin)	t _{ACBSY}				
AC_CYC = 0x0		8			μs
AC_CYC = 0x1		16.5			μs
AC_CYC = 0x2		33.5			μs
AC_CYC = 0x3		67.5			μs
AC_CYC = 0x4		84.5			μs
AC_CYC = 0x5		169			μs
AC_CYC = 0x6		339			μs
AC_CYC = 0x7		679			μs
Register Configuration Mode Setup Time	t _{REGCONFIG}	20			ns
$\overline{\text{RESET}}$ Low Time	t _{RESETL}	10			ns
Hardware Reset Delay (VDD Always Supplied)	t _{HWR_DELAY}	310			μs
Software Reset Delay	t _{SWR_DELAY}	310			μs
VDD Power-On Reset Delay	t _{POR_VDD}		2		ms
VIO Power-On Reset Delay (VDD Supplied Externally)	t _{POR_VIO1}		1.3		ms
LDO_IN Power-On Reset Delay	t _{POR_LDO}		3.2		ms
VIO Power-On Reset Delay (VDD Supplied by Internal LDO)	t _{POR_VIO2}		3		ms
LDO Wake-Up Command Power-On Reset Delay	t _{WAKEUP_SW}		3		ms
Hardware Reset Delay (Internal LDO Disabled)	t _{WAKEUP_HW}		3		ms

¹ For all specifications, the relative voltages for the AVDD and REF inputs follow the operating conditions specified in the reference and power requirements sections of [Table 1](#).

² The acquisition time for single-cycle command mode depends on the sample rate and SCK frequency (see the [Single-Cycle Command Mode](#) section).

ABSOLUTE MAXIMUM RATINGS

Table 3.

Parameter	Rating
Analog Inputs	
IN _n , ¹ COM to REFGND	-0.3 V to REF + 0.3 V
Reference Inputs	
REF, REFIN to AGND, REFGND, IOGND	-0.3 V to +6 V
REF to REFIN	-6.3 V to +6.3 V
Supply Inputs	
AVDD, LDO_IN to AGND, REFGND, IOGND	-0.3 V to +6 V
VDD, VIO to AGND, REFGND, IOGND	-0.3 V to +2.1 V
AVDD to LDO_IN	-6.3 V to +6.3 V
AVDD, LDO_IN to REF	-6.3 V to +6.3 V
VDD, VIO to AVDD, LDO_IN, REF	-6.3 V to +2.4 V
VDD to VIO	-2.4 V to +2.4 V
Ground	
AGND, IOGND to REFGND	-0.3 V to +0.3 V
AGND to IOGND	-0.3 V to +0.3 V
Digital Inputs ² to IOGND	-0.3 V to +6 V
Digital Outputs ² to IOGND	-0.3 V to VIO + 0.3 V
Storage Temperature Range	-65°C to +150°C
Junction Temperature	150°C
Lead Temperature Soldering	260°C reflow, as per JEDEC J-STD-020

¹ IN_n refers to the analog inputs, Pin IN0 through Pin IN15.

² See the [Pin Configuration and Function Descriptions](#) section for a list of the digital input and digital output pins.

Stresses at or above those listed under Absolute Maximum Ratings may cause permanent damage to the product. This is a stress rating only; functional operation of the product at these or any other conditions above those indicated in the operational section of this specification is not implied. Operation beyond the maximum operating conditions for extended periods may affect product reliability.

THERMAL RESISTANCE

Thermal performance is directly linked to printed circuit board (PCB) design and operating environment. Careful attention to PCB thermal design is required.

θ_{JA} is specified for worst case conditions and is the natural convection junction-to-ambient thermal resistance measured in a one cubic foot sealed enclosure, and θ_{JC} is the junction to case thermal resistance.

Thermal resistance values specified in [Table 4](#) were calculated based on JEDEC specifications and must be used in compliance with JESD51-12. The worst case junction temperature is reported.

θ_{JA} is highly dependent on the application and board layout. In applications where high maximum power dissipation exists, close attention to thermal board design is required. The θ_{JA} value can vary depending on printed circuit board (PCB) material, layout, and environmental conditions.

Table 4. Thermal Resistance

Package Type	θ_{JA} ¹	θ_{JC} ²	Unit
CP-32-7	40.2	17.5	°C/W
CP-36-5	41.8	0.1	°C/W

¹ Simulated values are based on the JEDEC 2S2P thermal test board with nine thermal vias in a JEDEC natural convection environment. See JEDEC JESD51.

² Simulated values are measured to the package top surface with a cold plate attached directly to the package top surface.

ELECTROSTATIC DISCHARGE (ESD) RATINGS

The following ESD information is provided for handling of ESD-sensitive devices in an ESD protected area only.

Human body model (HBM) per ANSI/ESDA/JEDEC JS-001.

Field induced charged device model (FICDM) per ANSI/ESDA/JEDEC JS-002.

ESD Ratings for AD4695/AD4696

Table 5. AD4695/AD4696 32-Lead LFCSP

ESD Model	Withstand Threshold (kV)	Class
HBM	4	3A
FICDM	1.25	C3

Table 6. AD4695/AD4696 36-Lead WLCSP

ESD Model	Withstand Threshold (kV)	Class
HBM	3	2
FICDM	1	C3

ESD CAUTION



ESD (electrostatic discharge) sensitive device. Charged devices and circuit boards can discharge without detection. Although this product features patented or proprietary protection circuitry, damage may occur on devices subjected to high energy ESD. Therefore, proper ESD precautions should be taken to avoid performance degradation or loss of functionality.

PIN CONFIGURATION AND FUNCTION DESCRIPTIONS

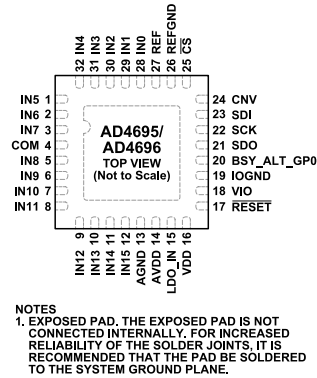

Figure 2. AD4695/AD4696 LFCSP Pin Configuration

Table 7. AD4695/AD4696 LFCSP Pin Function Descriptions

Pin No.	Mnemonic	Type ¹	Description
1	IN5	AI	Analog Input 5.
2	IN6	AI	Analog Input 6.
3	IN7	AI	Analog Input 7.
4	COM	AI	Common Channel Input. IN0 to IN15 can be paired with COM for the ADC core to sample the differential voltage between them. COM is nominally tied to signal ground (unipolar mode) or $V_{REF}/2$ (pseudobipolar mode). See the Channel Configuration Options section for a detailed description on pairing inputs, unipolar mode, and pseudobipolar mode.
5	IN8	AI	Analog Input 8.
6	IN9	AI	Analog Input 9.
7	IN10	AI	Analog Input 10.
8	IN11	AI	Analog Input 11.
9	IN12	AI	Analog Input 12.
10	IN13	AI	Analog Input 13.
11	IN14	AI	Analog Input 14.
12	IN15	AI	Analog Input 15.
13	AGND	P	Analog Supply Ground. AVDD, LDO_IN, and VDD are referenced to AGND.
14	AVDD	P	Analog Power Supply. AVDD is nominally 3.15 V to 5.5 V. Decouple AVDD to AGND with a local 100 nF capacitor.
15	LDO_IN	P	Internal LDO Input. LDO_IN is nominally 2.4 V to 5.5 V when the internal LDO is enabled. Decouple LDO_IN to AGND with a local 100 nF capacitor. If powering VDD with an external 1.8 V rail, tie LDO_IN to AGND. See the Internal LDO section for more information.
16	VDD	P	ADC Core Power Supply. VDD is nominally 1.8 V. VDD must be decoupled with a local 100 nF capacitor to AGND. When the internal LDO is enabled, VDD is internally generated. Disable the internal LDO when supplying VDD from an external source.
17	RESET	DI	Hardware Reset Input. Drive RESET low to perform a hardware reset of the device and reset the register states to the default values (see the Device Reset section).
18	VIO	P	Input/Output Interface Digital Power. VIO is nominally the same supply as the host interface (for example, 1.2 V to 1.8 V). Decouple VIO to IOGND with a local 100 nF capacitor.
19	IOGND	P	Input/Output Interface Digital Supply Ground. VIO is referenced to IOGND.
20	BSY_ALT_GPO	DI/DO	General-Purpose Pin 0. On the LFCSP option, BSY_ALT_GPO can be configured to function as a general-purpose input/output (GPIO), the threshold detection alert indicator, the busy indicator, or the second serial data output in dual-SDO mode (see the General-Purpose Pins section).
21	SDO	DO	Serial Data Output. When the device is configured in register configuration mode, SDO is used to read the configuration register data during SPI read transactions. When the device is configured in conversion mode, SDO is used to read the conversion results. Data output is synchronized to the falling edge of SCK.
22	SCK	DI	Serial Data Clock Input. SCK is used to clock out data on SDO and clock in data on SDI while the device is configured in either register configuration mode or conversion mode.
23	SDI	DI	Serial Data Input. When the device is configured in register configuration mode, SDI is used to perform SPI read and write transactions to access the configuration registers. In conversion mode, SDI receives 5-bit commands from the digital host, as shown in Table 18 .

PIN CONFIGURATION AND FUNCTION DESCRIPTIONS

Table 7. AD4695/AD4696 LFCSP Pin Function Descriptions

Pin No.	Mnemonic	Type ¹	Description
24	CNV	DI	Convert Input. When the device is configured in conversion mode, a rising edge on CNV initiates a conversion of the selected analog input. The AD4695/AD4696 can interface to a 4-wire SPI by tying CNV to \overline{CS} . See the Digital Interface Operation section for more information.
25	\overline{CS}	DI	Chip Select Input. When configured in register configuration mode, the \overline{CS} pin frames the SPI read and write transactions that access the configuration registers. When the device is configured in conversion mode, \overline{CS} can either be held low throughout the entire conversion or used to frame SPI transactions that read back conversion results. The AD4695/AD4696 can interface to a 4-wire SPI by tying CNV to \overline{CS} . See the Digital Interface Operation section for more information.
26	REFGND	P	Reference Ground. REF is referenced to REFGND. IN0 to IN15 can be paired with REFGND to the ADC core to sample the differential voltage between them. See the Channel Configuration Options section for a detailed description on pairing inputs.
27	REF	AI	Reference Input. V_{REF} must be provided by an external precision reference voltage between 2.4 V and 5.1 V. The REF pin must be decoupled with a minimum 1 μ F capacitor for optimal operation. See the Voltage Reference Input section for more information.
28	IN0	AI	Analog Input 0.
29	IN1	AI	Analog Input 1.
30	IN2	AI	Analog Input 2.
31	IN3	AI	Analog Input 3.
32	IN4	AI	Analog Input 4.
33	EPAD	NC	Exposed Pad. The exposed pad is not connected internally. For increased reliability of the solder joints, it is recommended that the pad be soldered to the system ground plane.

¹ AI is analog input, P is power, DI is digital input, DO is digital output, and NC is no internal connection.

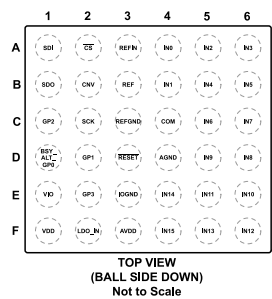

Figure 3. AD4695/AD4696 WLCSP Pin Configuration

Table 8. AD4695/AD4696 WLCSP Pin Function Descriptions

Pin No.	Mnemonic	Type ¹	Description
A1	SDI	DI	Serial Data Input. When the device is configured in register configuration mode, SDI is used to perform SPI read and write transactions to access the configuration registers. In conversion mode, SDI receives 5-bit commands from the digital host, as shown in Table 18 .
A2	\overline{CS}	DI	Chip Select Input. When configured in register configuration mode, the \overline{CS} pin frames the SPI read and write transactions that access the configuration registers. When the device is configured in conversion mode, \overline{CS} can either be held low throughout the entire conversion or used to frame SPI transactions that read back conversion results. The AD4695/AD4696 can interface to a 4-wire SPI by tying CNV to \overline{CS} . See the Digital Interface Operation section for more information.
A3	REFIN	AI	Internal Reference Buffer Input. The internal reference buffer can be used to buffer the reference voltage source and drive the REF pin internally. When the internal reference buffer is enabled, REFIN must be driven by an external precision reference source between 2.4 V and 5.1 V. When not using the internal reference buffer, REFIN must be tied to REF. See the Internal Reference Buffer section for more information.
A4	IN0	AI	Analog Input 0.
A5	IN2	AI	Analog Input 2.
A6	IN3	AI	Analog Input 3.
B1	SDO	DO	Serial Data Output. When the device is configured in register configuration mode, SDO is used to read the configuration register data during SPI read transactions. When the device is configured in conversion mode, SDO is used to read the conversion results. Data output is synchronized to the falling edge of SCK.

PIN CONFIGURATION AND FUNCTION DESCRIPTIONS

Table 8. AD4695/AD4696 WLCSP Pin Function Descriptions

Pin No.	Mnemonic	Type ¹	Description
B2	CNV	DI	Convert Input. When the device is configured in conversion mode, a rising edge on CNV initiates a conversion of the selected analog input. The AD4695/AD4696 can interface to a 4-wire SPI by tying CNV to CS. See the Digital Interface Operation section for more information.
B3	REF	AI	Reference Input. V_{REF} must be provided by an external precision reference voltage between 2.4 V and 5.1 V. The REF pin must be decoupled with a minimum 1 μ F capacitor for optimal operation. See the Voltage Reference Input section for more information.
B4	IN1	AI	Analog Input 1.
B5	IN4	AI	Analog Input 4.
B6	IN5	AI	Analog Input 5.
C1	GP2	DI/DO	General-Purpose Pin 2. Can be configured to function as a general-purpose input/output, the threshold detection alert indicator, or the third serial data output in quad-SDO mode (see the General-Purpose Pins section).
C2	SCK	DI	Serial Data Clock Input. SCK is used to clock out data on SDO and clock in data on SDI while the device is configured in either register configuration mode or conversion mode.
C3	REFGND	P	Reference Ground. REF is referenced to REFGND. IN0 to IN15 can be paired with REFGND to the ADC core to sample the differential voltage between them. See the Channel Configuration Options section for a detailed description on pairing inputs.
C4	COM	AI	Common Channel Input. IN0 to IN15 can be paired with COM for the ADC core to sample the differential voltage between them. COM is nominally tied to signal ground (unipolar mode) or $V_{REF}/2$ (pseudobipolar mode). See the Channel Configuration Options section for a detailed description on pairing inputs, unipolar mode, and pseudobipolar mode.
C5	IN6	AI	Analog Input 6.
C6	IN7	AI	Analog Input 7.
D1	BSY_ALT_GP0	DI/DO	General-Purpose Pin 0. On the WLCSP option, BSY_ALT_GP0 can be configured to function as a general-purpose input/output (GPIO), the threshold detection alert indicator, or the busy indicator (see the General-Purpose Pins section).
D2	GP1	DI/DO	General-Purpose Pin 1. Can be configured to function as a general-purpose input/output, or the second serial data output in dual- and quad-SDO modes (see the General-Purpose Pins section).
D3	RESET	DI	Hardware Reset Input. Drive RESET low to perform a hardware reset of the device and reset the register states to the default values (see the Device Reset section).
D4	AGND	P	Analog Supply Ground. AVDD, LDO_IN, and VDD are referenced to AGND.
D5	IN9	AI	Analog Input 9.
D6	IN8	AI	Analog Input 8.
E1	VIO	P	Input/Output Interface Digital Power. VIO is nominally the same supply as the host interface (for example, 1.2 V to 1.8 V). Decouple VIO to IOGND with a local 100 nF capacitor.
E2	GP3	DI/DO	General-Purpose Pin 3. Can be configured to function as a general-purpose input/output, the busy indicator, or the fourth serial data output in quad-SDO mode (see the General-Purpose Pins section).
E3	IOGND	P	Input/Output Interface Digital Supply Ground. VIO is referenced to IOGND.
E4	IN14	AI	Analog Input 14.
E5	IN11	AI	Analog Input 11.
E6	IN10	AI	Analog Input 10.
F1	VDD	P	ADC Core Power Supply. VDD is nominally 1.8 V. VDD must be decoupled with a local 100 nF capacitor to AGND. When the internal LDO is enabled, VDD is internally generated. Disable the internal LDO when supplying VDD from an external source.
F2	LDO_IN	P	Internal LDO Input. LDO_IN is nominally 2.4 V to 5.5 V when the internal LDO is enabled. Decouple LDO_IN to AGND with a local 100 nF capacitor. If powering VDD with an external 1.8 V rail, tie LDO_IN to AGND. See the Internal LDO section for more information.
F3	AVDD	P	Analog Power Supply. AVDD is nominally 3.15 V to 5.5 V. Decouple AVDD to AGND with a local 100 nF capacitor.
F4	IN15	AI	Analog Input 15.
F5	IN13	AI	Analog Input 13.
F6	IN12	AI	Analog Input 12.

¹ AI is analog input, P is power, DI is digital input, DO is digital output, and NC is no internal connection.

TYPICAL PERFORMANCE CHARACTERISTICS

AVDD = LDO_IN = 5 V, VIO = 1.8 V, VREF = 5 V, fSCK = 50 MHz, unipolar mode, analog input high-Z mode enabled, reference input high-Z mode enabled, internal LDO enabled, fS = 1 MSPS for the AD4696, fS = 500 kSPS for the AD4695, no active clamps, autocycle mode disabled, OSR = 1, and TA = 25°C, unless otherwise specified.

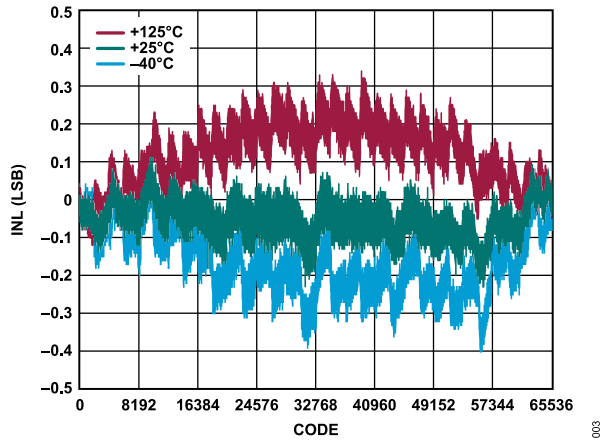

Figure 4. INL vs. Code, VREF = 5 V

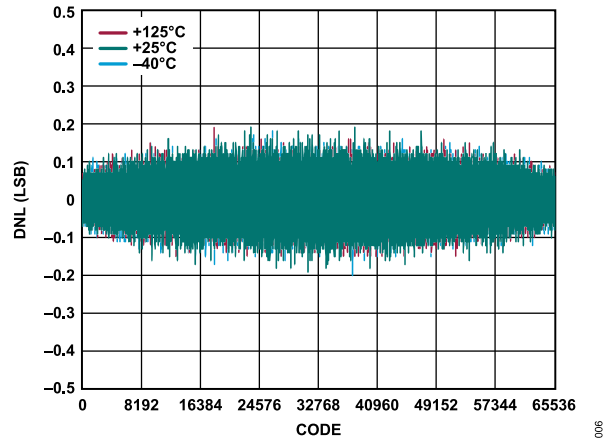

Figure 7. DNL vs. Code, VREF = 5 V

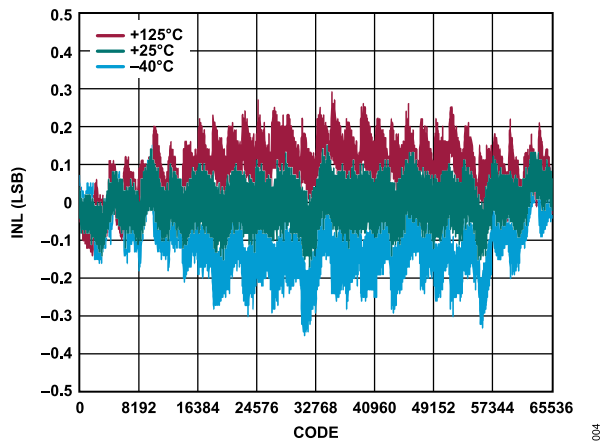

Figure 5. INL vs. Code, VREF = 4.096 V

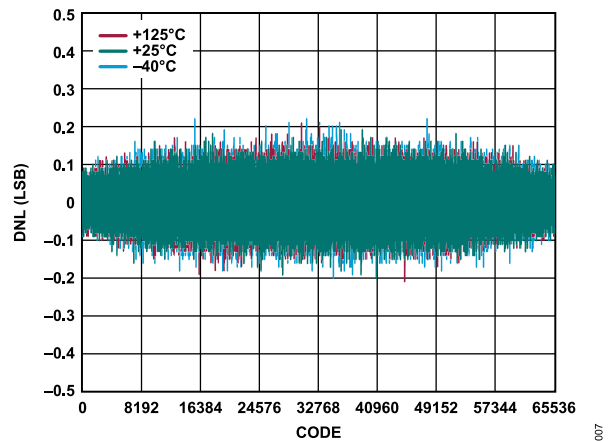

Figure 8. DNL vs. Code, VREF = 4.096 V

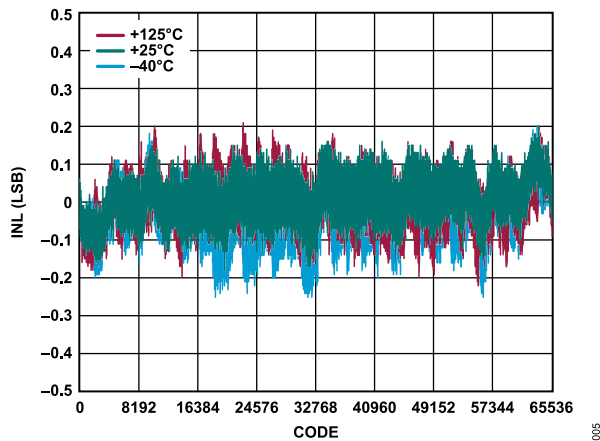

Figure 6. INL vs. Code, VREF = 2.5 V

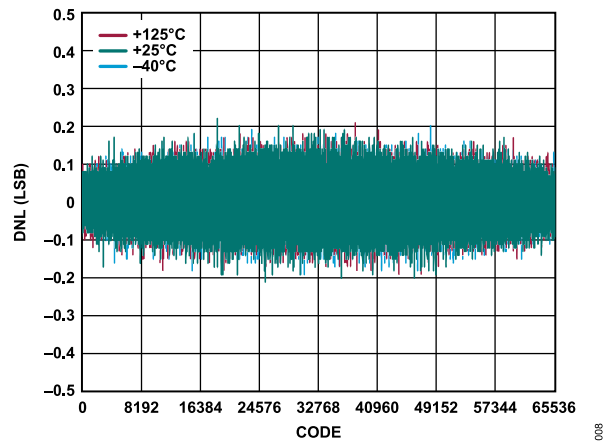

Figure 9. DNL vs. Code, VREF = 2.5 V

TYPICAL PERFORMANCE CHARACTERISTICS

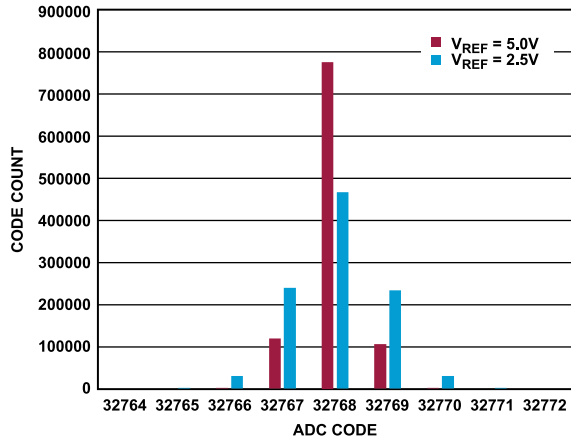

Figure 10. Histogram of a DC Input at Code Center, OSR = 1

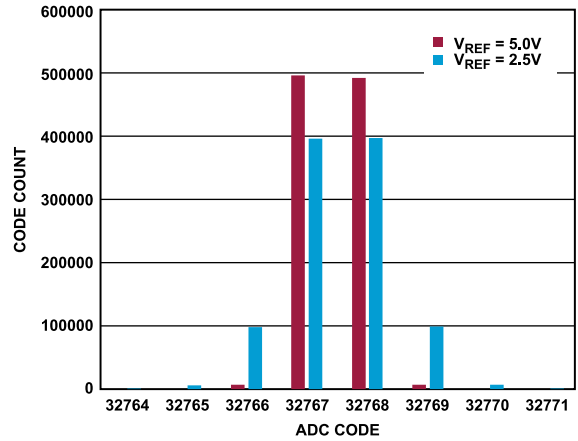

Figure 13. Histogram of a DC Input at Code Transition, OSR = 1

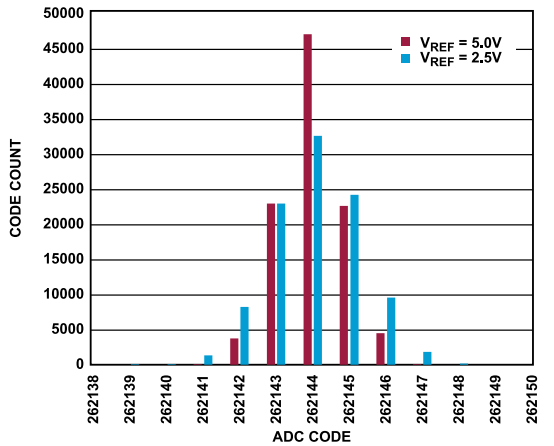

Figure 11. Histogram of a DC Input at Code Center, OSR = 64

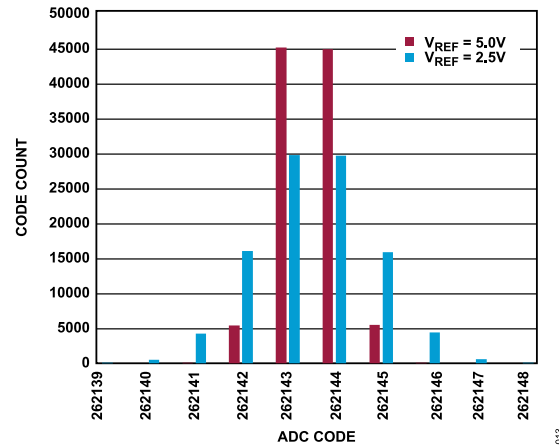

Figure 14. Histogram of a DC Input at Code Transition, OSR = 64

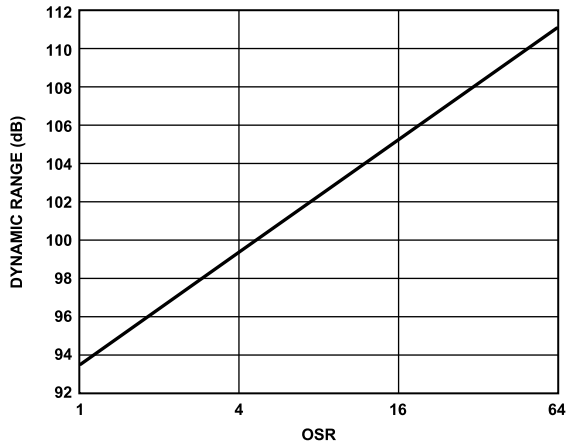

Figure 12. Dynamic Range vs. OSR

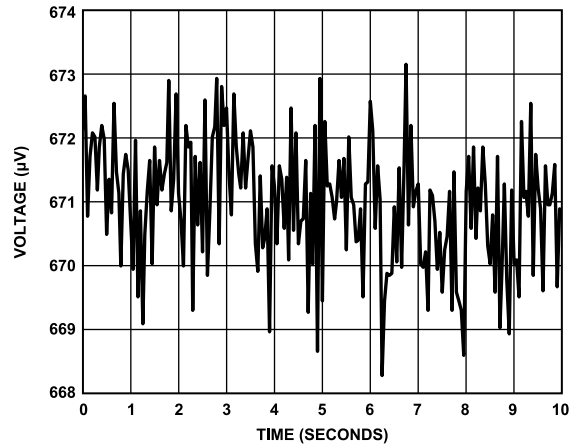

Figure 15. 1/f Noise (0.1 Hz to 10 Hz Bandwidth), 50 kSPS, 2500 Samples Averaged per Reading

TYPICAL PERFORMANCE CHARACTERISTICS

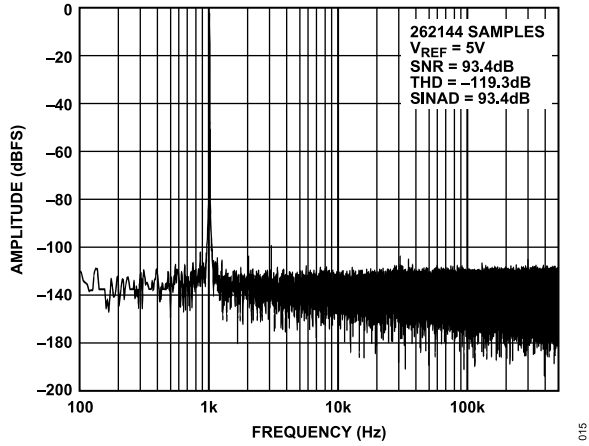

Figure 16. Fast Fourier Transform (FFT), $f_{IN} = 1\text{ kHz}$, $V_{REF} = 5\text{ V}$, $OSR = 1$

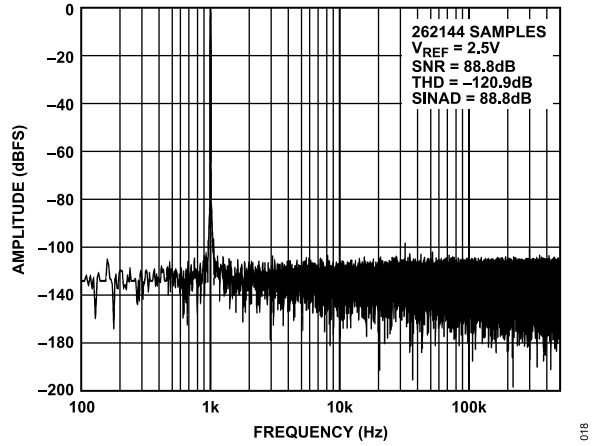

Figure 19. FFT, $f_{IN} = 1\text{ kHz}$, $V_{REF} = 2.5\text{ V}$, $OSR = 1$

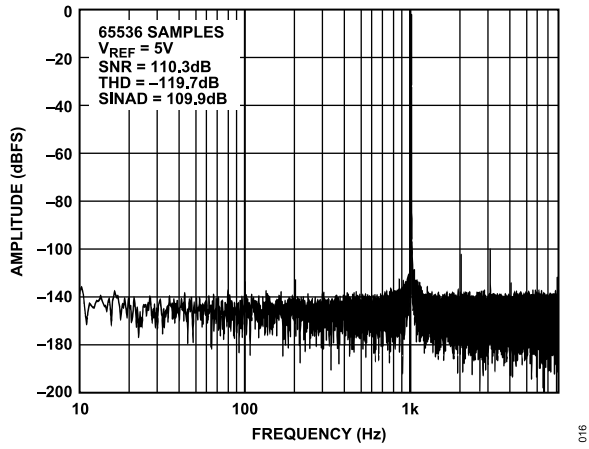

Figure 17. FFT, $f_{IN} = 1\text{ kHz}$, $V_{REF} = 5\text{ V}$, $OSR = 64$

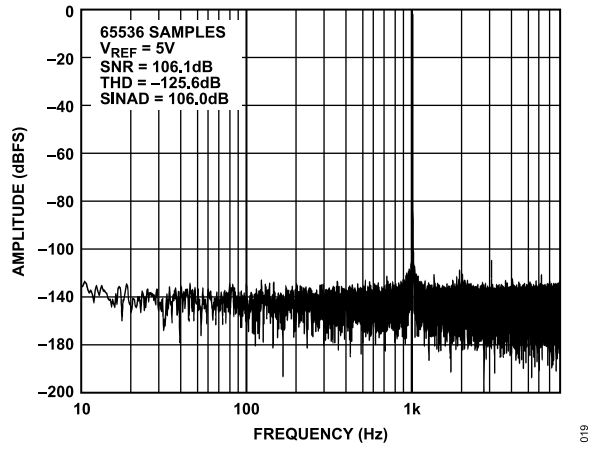

Figure 20. FFT, $f_{IN} = 1\text{ kHz}$, $V_{REF} = 2.5\text{ V}$, $OSR = 64$

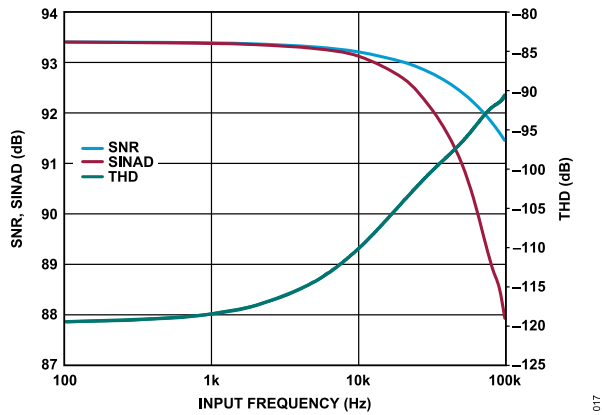

Figure 18. SNR, SINAD, and THD vs. Input Frequency

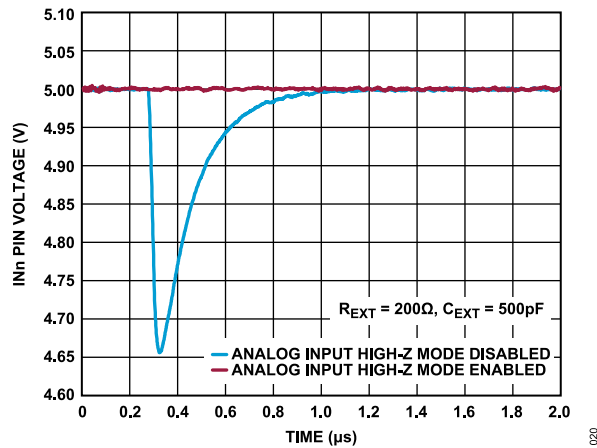

Figure 21. Analog Input Voltage Step with Analog Input High-Z Mode Disabled and Enabled

TYPICAL PERFORMANCE CHARACTERISTICS

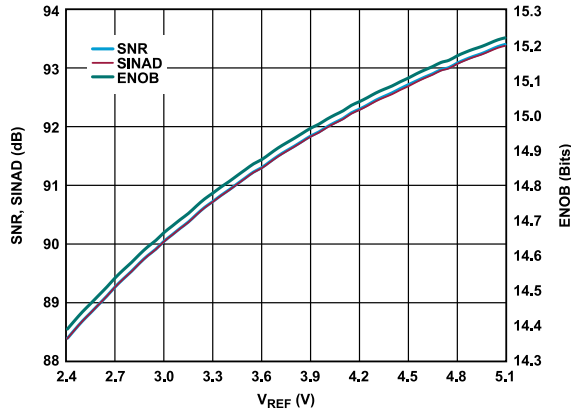

Figure 22. SNR, SINAD, and Effective Number of Bits (ENOB) vs. V_{REF} , $f_{IN} = 1$ kHz

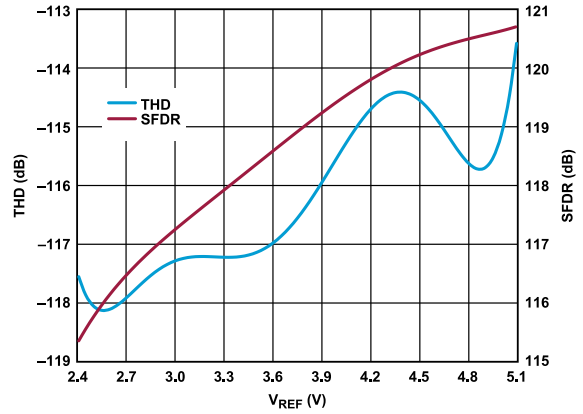

Figure 25. THD and SFDR vs. V_{REF} , $f_{IN} = 1$ kHz

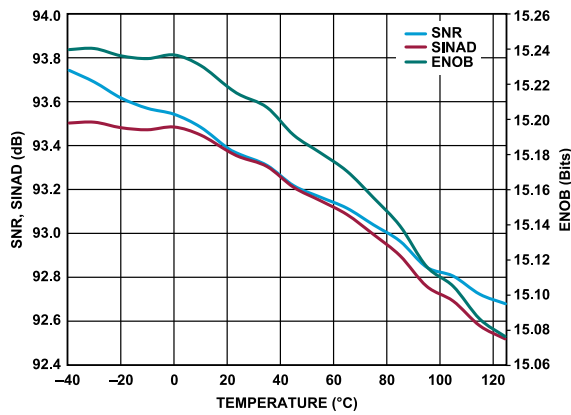

Figure 23. SNR, SINAD, and ENOB vs. Temperature, $f_{IN} = 1$ kHz

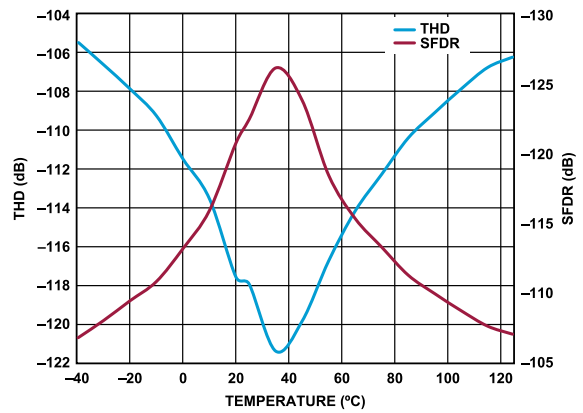

Figure 26. THD and SFDR vs. Temperature, $f_{IN} = 1$ kHz

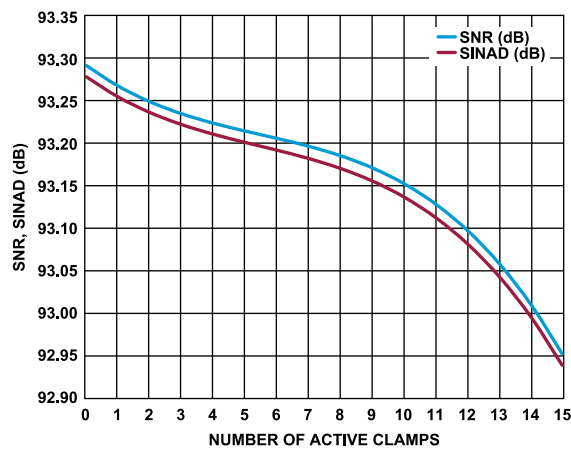

Figure 24. SNR, SINAD vs. Number of Active Clamps, Reduced Current Mode Disabled

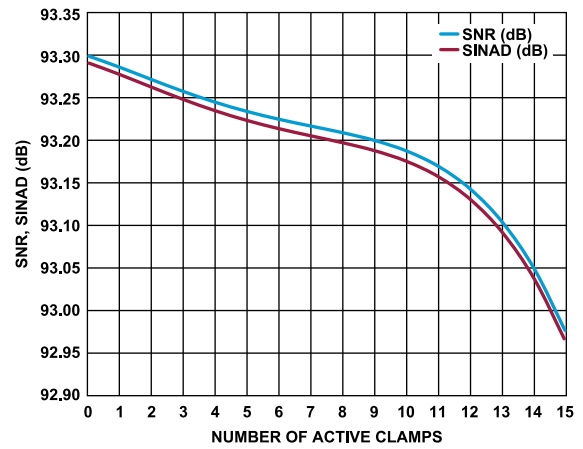

Figure 27. SNR, SINAD vs. Number of Active Clamps, Reduced Current Mode Enabled

TYPICAL PERFORMANCE CHARACTERISTICS

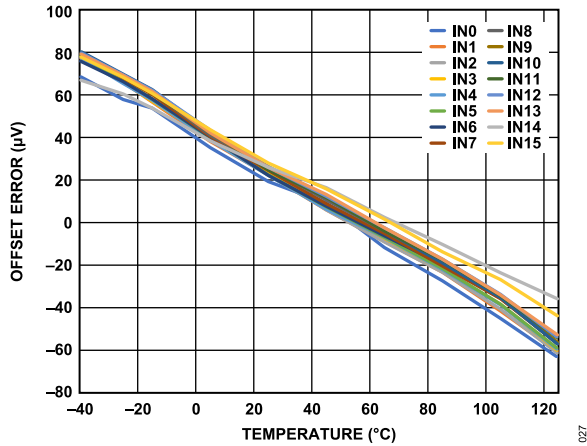

Figure 28. Offset Error vs. Temperature

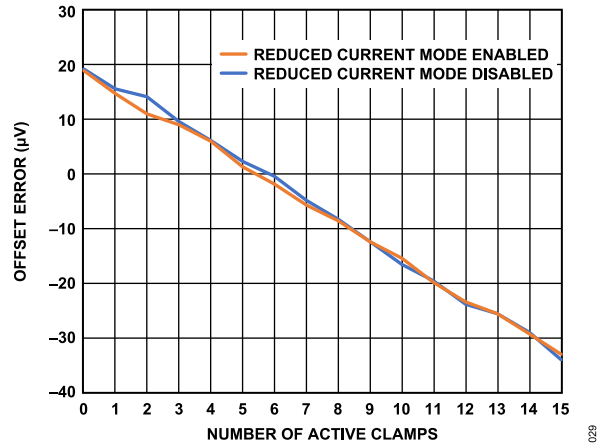

Figure 31. Offset Error vs. Number of Active Clamps, Clamp Current = 5 mA

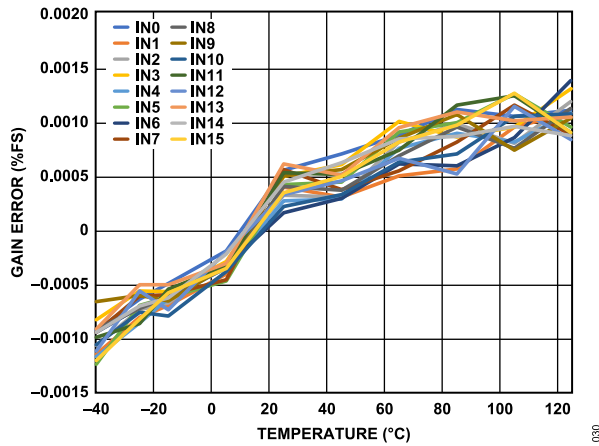

Figure 29. Gain Error vs. Temperature, Internal Reference Buffer Disabled

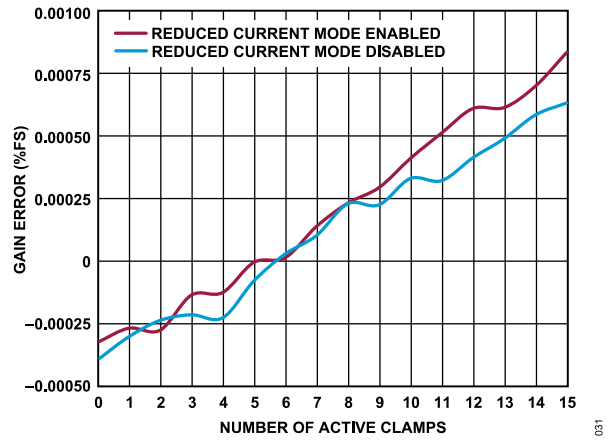

Figure 32. Gain Error vs. Number of Active Clamps, Clamp Current = 5 mA, Internal Reference Buffer Disabled

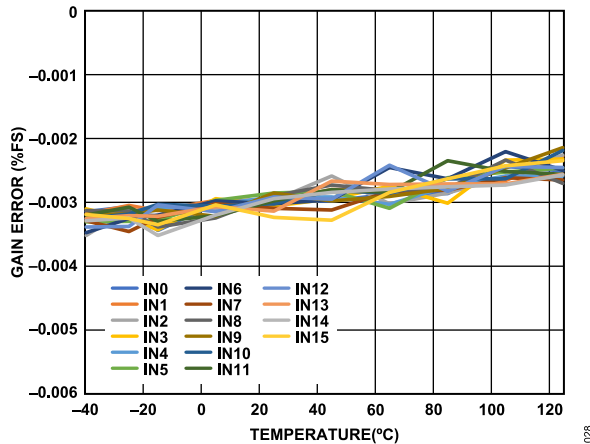

Figure 30. Gain Error vs. Temperature, Internal Reference Buffer Enabled

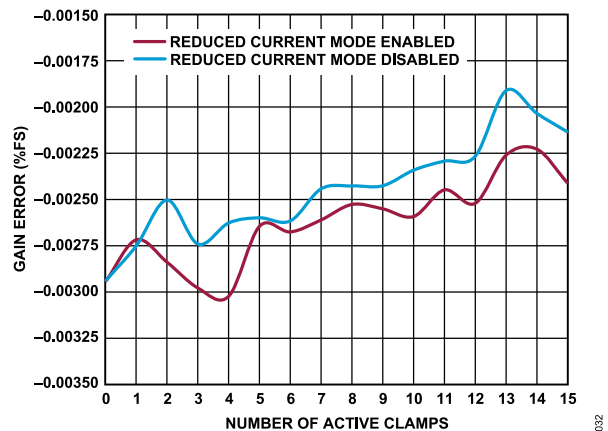

Figure 33. Gain Error vs. Number of Active Clamps, Clamp Current = 5 mA, Internal Reference Buffer Enabled

TYPICAL PERFORMANCE CHARACTERISTICS

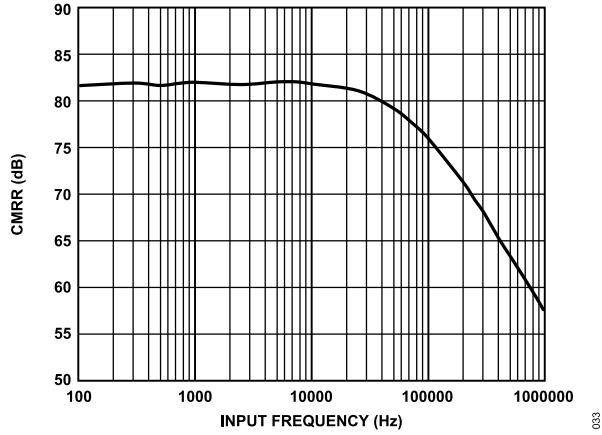

Figure 34. CMRR vs. Input Frequency

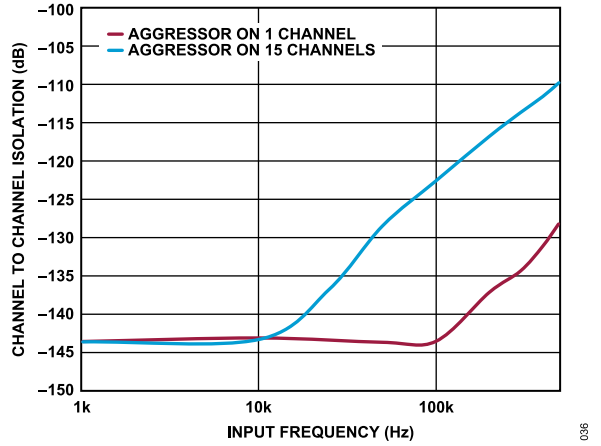

Figure 37. Channel to Channel Isolation vs. Input Frequency

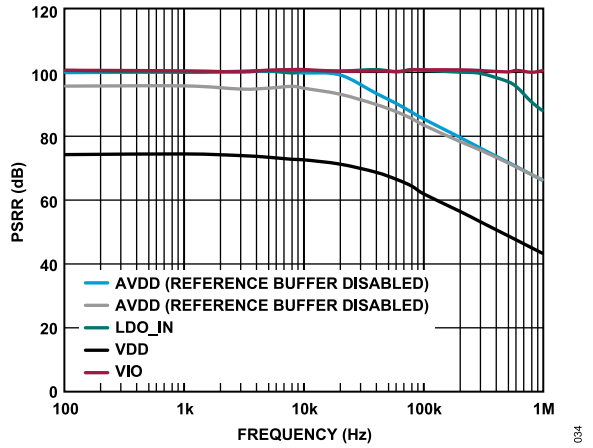

Figure 35. PSRR vs. Frequency

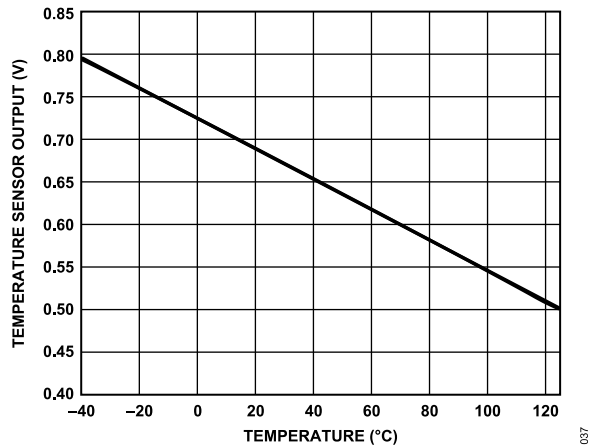

Figure 38. Temperature Sensor Output vs. Temperature

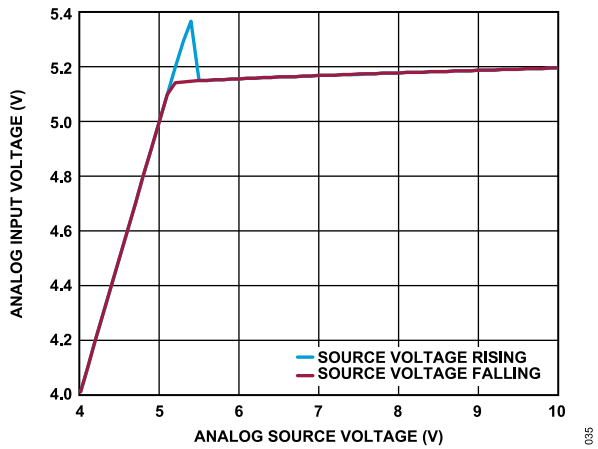

Figure 36. Analog Input Voltage vs. Analog Source Voltage, $R_{EXT} = 1\text{ k}\Omega$, $V_{REF} = 5\text{ V}$

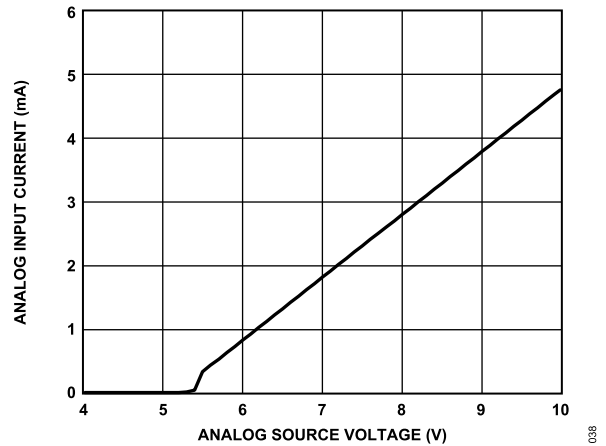

Figure 39. Analog Input Current vs. Analog Source Voltage, $R_{EXT} = 1\text{ k}\Omega$, $V_{REF} = 5\text{ V}$

TYPICAL PERFORMANCE CHARACTERISTICS

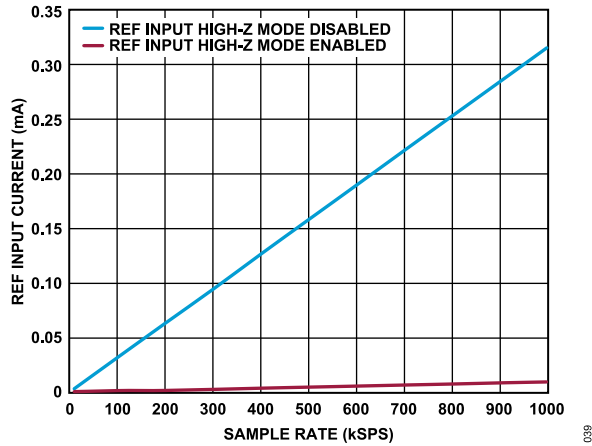

Figure 40. REF Input Current vs. Sample Rate, $V_{REF} = 5 V$

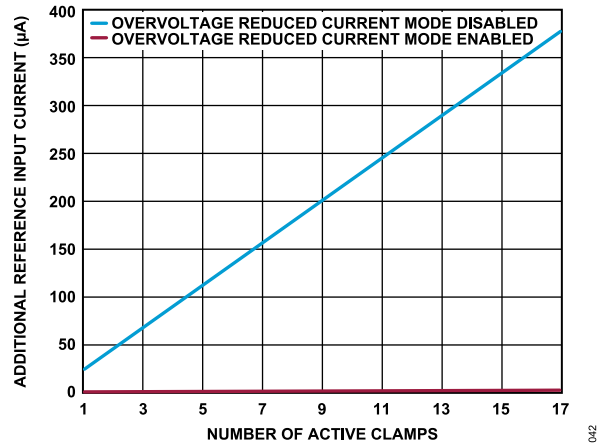

Figure 43. Additional Reference Input Current vs. Number of Active Clamps, Clamp Current = 5 mA, $V_{REF} = 5 V$

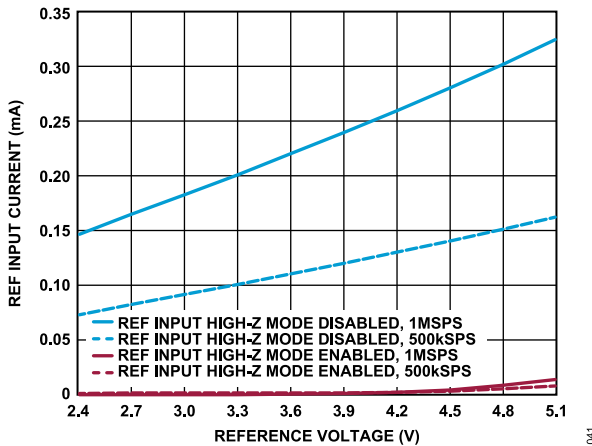

Figure 41. REF Input Current vs. Reference Voltage, $f_s = 1 \text{ MSPS}$ and 500 kSPS

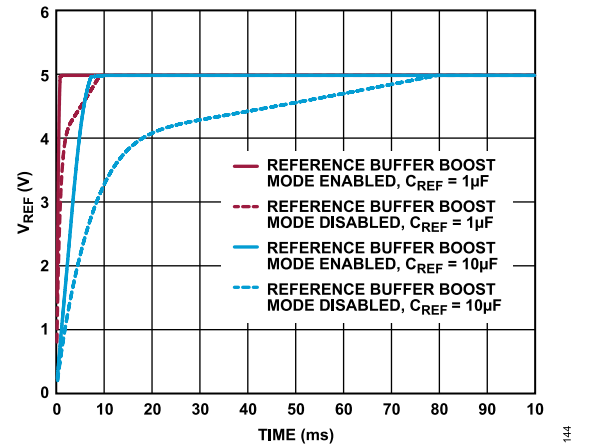

Figure 44. V_{REF} vs. Time for Various Reference Buffer Boost Mode Settings and C_{REF}

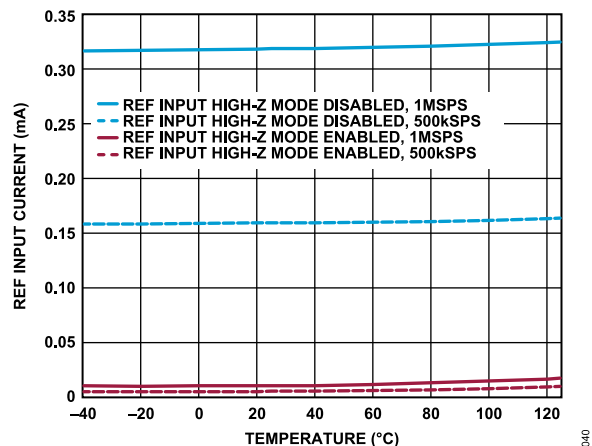

Figure 42. REF Input Current vs. Temperature, $V_{REF} = 5 V$, Frequency of CNV Signal (f_{CNV}) = 1 MSPS

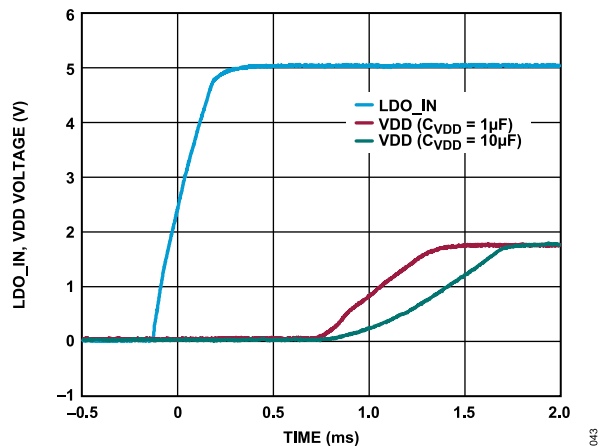

Figure 45. LDO_IN, VDD Voltage vs. Time and VDD Decoupling Capacitance (C_{VDD})

TYPICAL PERFORMANCE CHARACTERISTICS

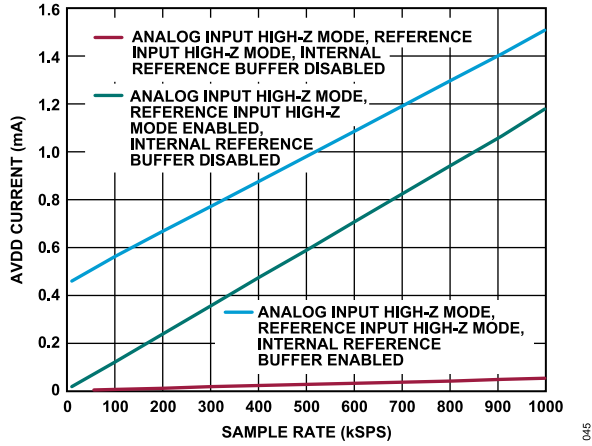

Figure 46. AVDD Current vs. Sample Rate

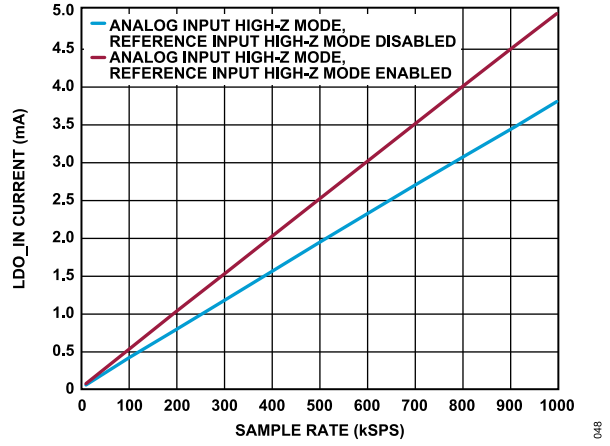

Figure 49. LDO_IN Current vs. Sample Rate, Internal LDO Enabled

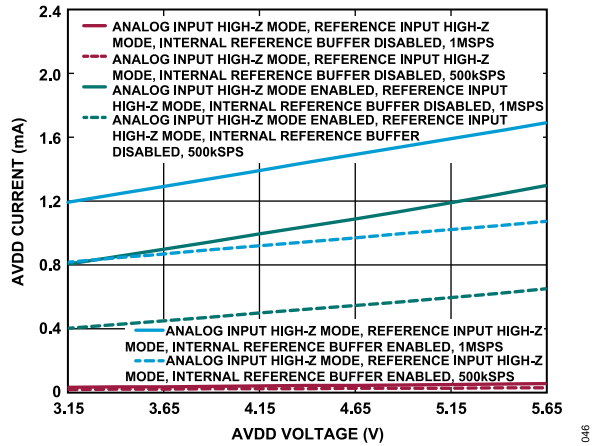

Figure 47. AVDD Current vs. AVDD Voltage

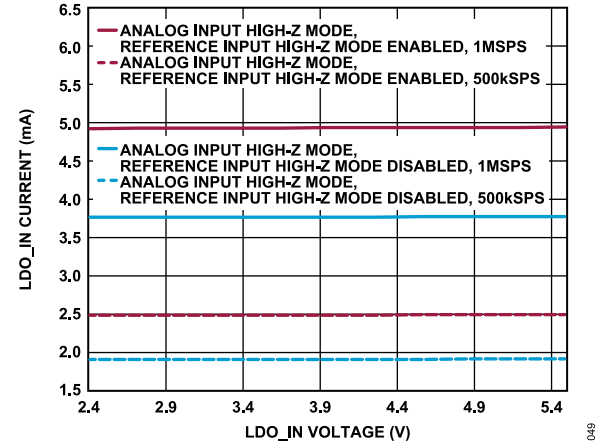

Figure 50. LDO_IN Current vs. LDO_IN Voltage, Internal LDO Enabled

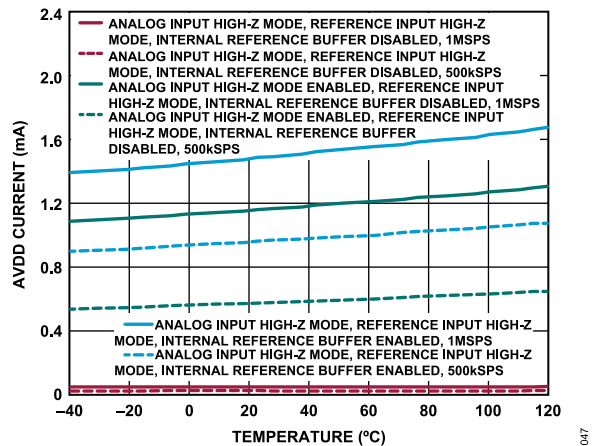

Figure 48. AVDD Current vs. Temperature

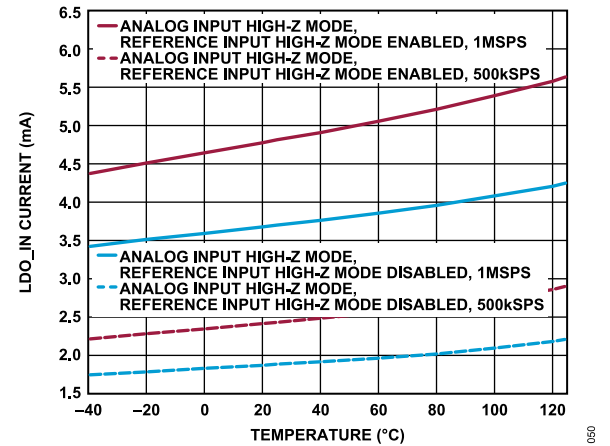

Figure 51. LDO_IN Current vs. Temperature, Internal LDO Enabled

TYPICAL PERFORMANCE CHARACTERISTICS

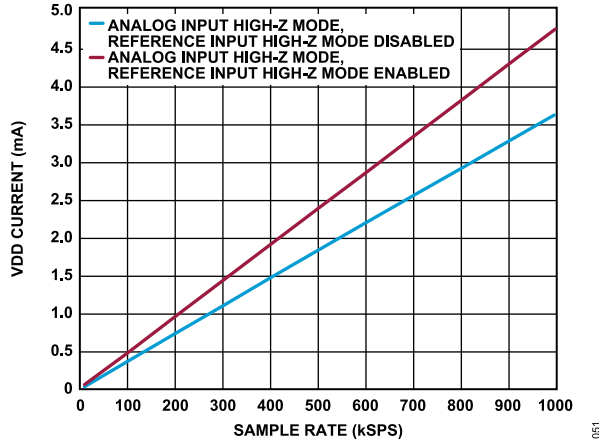

Figure 52. VDD Current vs. Sample Rate, Internal LDO Disabled

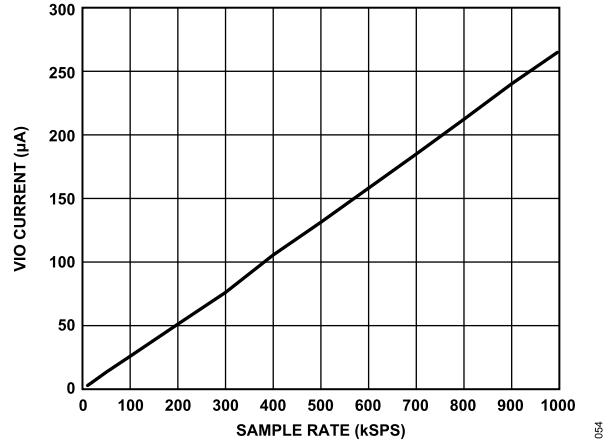

Figure 55. VIO Current vs. Sample Rate, Conversion Mode, OSR = 1

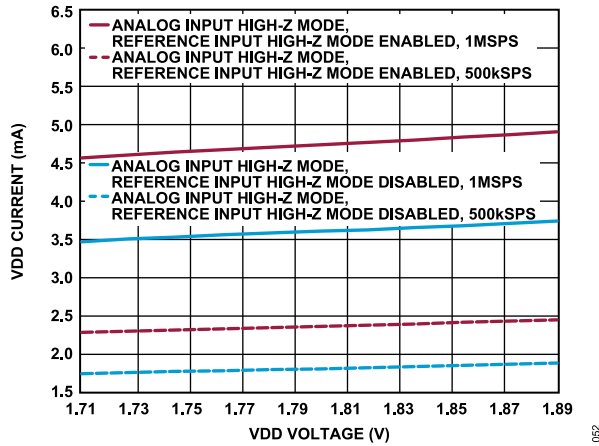

Figure 53. VDD Current vs. VDD Voltage, Internal LDO Disabled

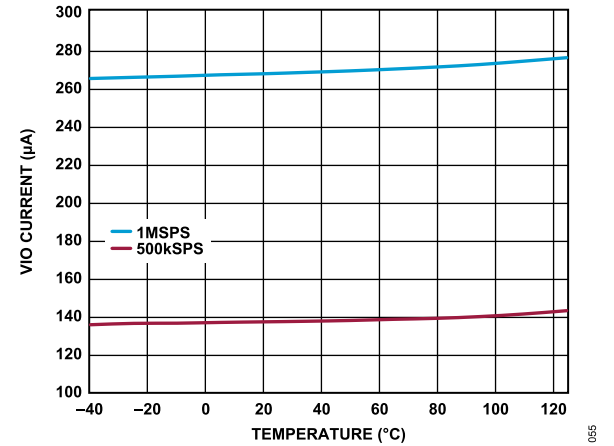

Figure 56. VIO Current vs. Temperature, Conversion Mode, OSR = 1

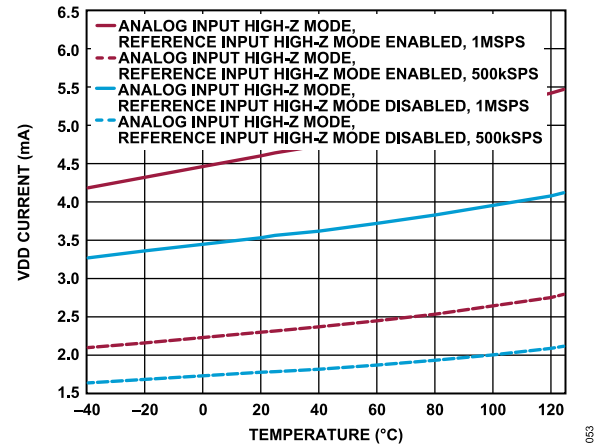

Figure 54. VDD Current vs. Temperature, Internal LDO Disabled

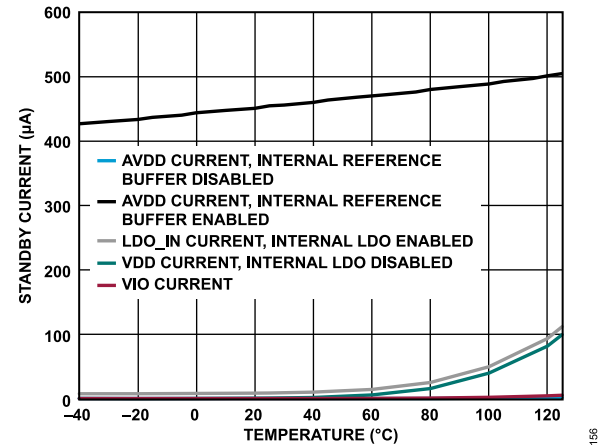

Figure 57. Standby Current vs. Temperature

TYPICAL PERFORMANCE CHARACTERISTICS

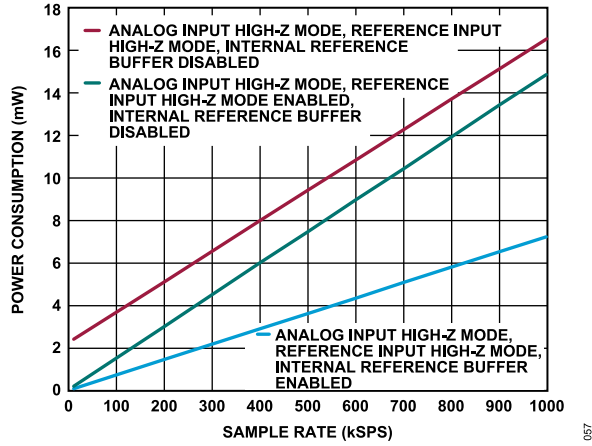

Figure 58. Power Consumption vs. Sample Rate, Internal LDO Disabled

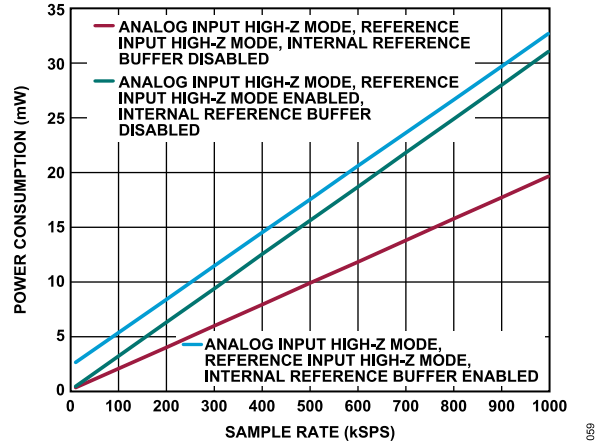

Figure 61. Power Consumption vs. Sample Rate, Internal LDO Enabled

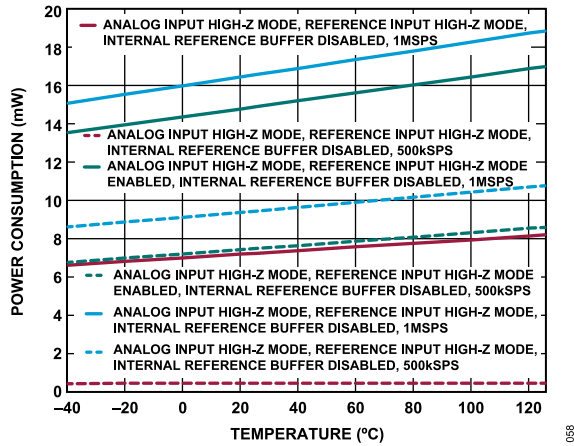

Figure 59. Power Consumption vs. Temperature, Internal LDO Disabled, $f_s = 1$ MSPS and 500 kSPS

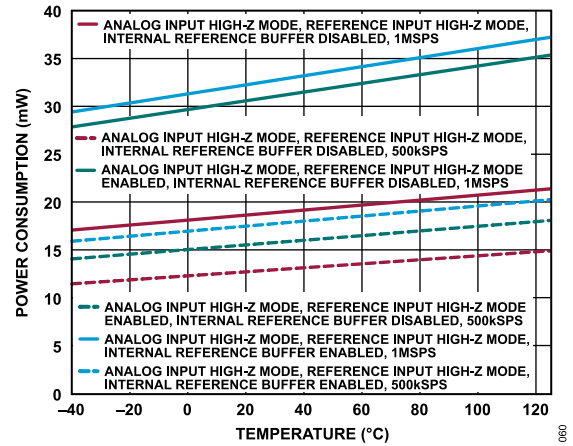

Figure 62. Power Consumption vs. Temperature, Internal LDO Enabled, $f_s = 1$ MSPS and 500 kSPS

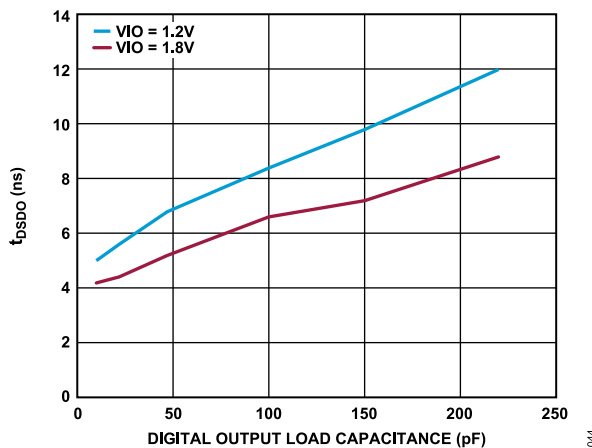

Figure 60. t_{DSDO} vs. Digital Output Load Capacitance

TERMINOLOGY

Integral Nonlinearity Error (INL)

INL is the maximum deviation from a straight line passing through the endpoints of the ADC transfer function. The endpoints of the transfer function are zero scale, a point $\frac{1}{2}$ LSB below the first code transition, and full scale, a point $\frac{1}{2}$ LSB above the last code transition.

Differential Nonlinearity Error (DNL)

In an ideal ADC, code transitions are 1 LSB apart. DNL is the maximum deviation from this ideal value. DNL is often specified in terms of resolution for which no missing codes are guaranteed.

Offset Error

The offset error is the deviation of the measured transition between $-FSR$ and $-FSR + 1$ from the ideal transition, measured in volts. The ideal transition between $-FSR$ and $-FSR + 1$ occurs at an analog input level $\frac{1}{2}$ LSB above the $IN-$ voltage (see the [Transfer Function](#) section).

Offset Error Match

Offset error match is the difference in offset error between any two input channels.

Gain Error

The gain error is the deviation of the measured transition between $+FSR - 1$ and $+FSR$ from the ideal transition, and is measured in percentage of full scale (%FS). The ideal transition between $+FSR - 1$ and $+FSR$ occurs for an analog input level $1\frac{1}{2}$ LSB below the nominal full scale (see the [Transfer Function](#) section).

Gain Error Match

Gain error match is the difference in gain error between any two input channels.

Spurious-Free Dynamic Range (SFDR)

SFDR is the difference, in decibels (dB), between the rms amplitude of the input signal and the peak spurious signal.

Effective Number of Bits (ENOB)

ENOB is a measurement of the resolution with a sine wave input and is related to SINAD by the following formula:

$$ENOB = (SINAD - 1.76)/6.02$$

ENOB is expressed in bits.

Noise Free Code Resolution

Noise free code resolution is the number of bits beyond which it is impossible to distinctly resolve individual codes. To calculate the resolution, use the following equation:

$$Noise\ Free\ Code\ Resolution = \log_2(2^N / Peak\text{-}to\ Peak\text{-}Noise)$$

Noise free code resolution is expressed in bits.

Dynamic Range

Dynamic range is the ratio of the rms value of the full scale to the total rms noise measured with the inputs shorted together. The value for dynamic range is expressed in dB and is measured with a signal at -60 dBFS to include all noise sources and DNL artifacts.

Signal-to-Noise Ratio (SNR)

SNR is the ratio of the rms value of the actual input signal to the rms sum of all other spectral components below the Nyquist frequency, excluding harmonics and dc. The value for SNR is expressed in dB.

Signal-to-Noise-and-Distortion Ratio (SINAD)

SINAD is the measured ratio of signal-to-noise-and-distortion at the output of the ADC. The signal is the rms amplitude of the fundamental. Noise is the sum of all nonfundamental signals up to half the sampling frequency ($f_s/2$), excluding dc.

Channel to Channel Memory

Channel to channel memory is a measure of the level of cross-talk that occurs when switching between channels in a channel sequence. It is measured by applying a full-scale, 100 kHz signal to one analog input channel and a dc voltage on another analog input channel, and repeatedly switching between the two channels between each conversion. The channel to channel memory is the magnitude at 100 kHz in the spectrum measured from the dc channel data.

Channel to Channel Isolation

Channel to channel isolation is a measure of the level of crosstalk from a signal on an inactive channel to an active channel. To measure channel to channel isolation, apply a dc input to one analog input channel and a full-scale, 100 kHz sine wave signal to all other analog input channels and perform conversions only on the dc input channel. The channel to channel isolation is the magnitude at 100 kHz in the spectrum measured from the dc channel data.

Total Harmonic Distortion (THD)

THD is the ratio of the rms sum of harmonics to the fundamental and is defined as

$$THD(dB) = 20 \log \frac{\sqrt{V_2^2 + V_3^2 + V_4^2 + V_5^2 + V_6^2}}{V_1} \quad (1)$$

where:

V_1 is the rms amplitude of the fundamental.

$V_2, V_3, V_4, V_5,$ and V_6 are the rms amplitudes of the second through the sixth harmonic.

Aperture Delay

Aperture delay is the measure of the acquisition performance. Aperture delay is the time between the rising edge of the CNV input and when the input signal is held for a conversion.

THEORY OF OPERATION

OVERVIEW

The AD4695/AD4696 are low power, 16-channel, 16-bit, 500 kSPS/1 MSPS, multiplexed, precision SAR ADCs. The AD4695/AD4696 offer valid first conversion results even after being idle for long periods of time.

The AD4695/AD4696 include features that simplify the design requirements of peripheral circuitry and facilitate high performance data acquisition system designs with low power consumption and high channel density. These features include the following:

- ▶ 16-bit SAR ADC core with no missing codes
- ▶ 16 multiplexed analog inputs with low crosstalk multiplexer
- ▶ Flexible channel sequencing modes
- ▶ Analog input and reference high-Z mode
- ▶ Internal reference buffer (WLCSP option only)
- ▶ Temperature sensor
- ▶ Input overvoltage protection clamps on each analog input
- ▶ Programmable threshold detection for each analog input
- ▶ Autocycle mode for performing conversions autonomously
- ▶ First-order offset and gain correction for each analog input
- ▶ Oversampling and decimation options for each analog input

When multiplexing between channels, the analog input high-Z mode feature reduces the nonlinear voltage steps that occur at the analog inputs. Analog input high-Z mode relaxes settling and bandwidth requirements of the analog front-end circuitry and allows lower bandwidth and lower power amplifiers to drive the analog inputs directly.

The reference input high-Z mode feature significantly reduces the REF input current while the ADC core performs conversions to relax the drive requirements of the reference circuitry. This feature allows the use of lower power references and smaller reference decoupling capacitors (1 μF) than with traditional SAR ADCs.

The WLCSP option also includes an internal reference buffer with high input impedance for directly interfacing with low power references.

Each analog input is equipped with input overvoltage protection clamps to protect the device from overvoltage events. The circuits of the clamps are robust and prevent overvoltage events on an analog input from significantly impacting the performance of the other analog inputs.

The AD4695/AD4696 include a variety of channel sequencing modes that provide a flexible means of performing conversions on a sequence of analog input channels. The standard sequencer and advanced sequencer allow a channel sequence to be preprogrammed and automatically progressed as conversions occur. Two-cycle command mode and single-cycle command mode allow the digital host to manually select from the channels with SPI commands.

The AD4695/AD4696 have an enhanced digital interface that is used to access the device register contents and initiate and read conversion results while providing additional utility. Register configuration mode is used to read and write to the register contents. Conversion mode is used to initiate conversions and read back conversion results. The fast conversion time of the AD4695/AD4696 allows low serial clock rates to read back conversions even when running at full throughput. The AD4695/AD4696 support 4-wire SPI protocol and have optional dual- and quad-SDO modes that enable slower SCK rates by shifting out conversion results on multiple data outputs in parallel.

The power consumption of the AD4695/AD4696 scales with throughput because the ADC core powers down between conversions. When operating at 10 kSPS, for example, the AD4695/AD4696 typically consume 85 μW (with internal LDO, analog input high-Z mode, reference high-Z mode and internal reference buffer disabled), making the devices suitable for battery-powered applications.

The AD4695/AD4696 are available in a 32-lead, 5 mm \times 5 mm LFCSP or in a 36-lead 2.96 mm \times 2.96 mm WLCSP.

CONVERTER OPERATION

The AD4695/AD4696 contain an SAR-based ADC core that utilizes a charge redistribution digital-to-analog-converter (DAC) to quantize the applied input voltage to an output code. [Figure 63](#) shows a simplified schematic of the AD4695/AD4696 SAR ADC core.

The analog inputs and the temperature sensor are connected to the capacitor array inputs (ADCIN+ and ADCIN-) via the internal low crosstalk multiplexer, represented by SW_{MUX+} and SW_{MUX-} in [Figure 63](#). The multiplexer switches are controlled by the internal channel sequencing logic and are updated once per conversion (see the [Multiplexer](#) section and the [Channel Sequencing Modes](#) section).

The AD4695/AD4696 SAR ADC conversion routine consists of an acquisition phase and a conversion phase. The ADC remains in the acquisition phase until the conversion phase begins. During the acquisition phase, the capacitor array acquires the voltage on the analog input channel selected by the internal multiplexer. During the conversion phase, the ADC core samples the input voltage and generates a corresponding output code result. [Figure 64](#) shows the data processing path for the conversion results generated by the AD4695/AD4696 ADC core.

The AD4695/AD4696 must be in conversion mode to initiate the conversion phase (see the [Conversion Mode](#) section). In register configuration mode, the SAR ADC core remains in the acquisition phase.

During the acquisition phase, the terminals of the capacitor array tied to the input of the comparator are connected to REFGND through the SW+ and SW- switches. All switches on the individual capacitors in the array are connected to ADCIN+ and ADCIN-, and ADCIN+ and ADCIN- are connected to the selected analog input

THEORY OF OPERATION

channel through SW_{MUX+} and SW_{MUX-} . The acquisition phase ends immediately at the beginning of the conversion phase.

The conversion phase is initiated by a rising edge on the CNV input (in conversion mode only). When the conversion phase begins, $SW+$, $SW-$, SW_{MUX+} , and SW_{MUX-} open first and sample the analog input voltage on the capacitor arrays. The two capacitor arrays are then disconnected from $ADCIN+$ and $ADCIN-$ and connected to $REFGND$. The sampled voltage is applied to the comparator inputs, which causes the comparator to become unbalanced. The ADC control logic performs a bit trial for each capacitor in the array, starting with the MSB, by switching each element of the capacitor array between $REFGND$ and REF in sequence. During each bit trial, the comparator input varies by binary weighted voltage steps ($V_{REF}/2$, $V_{REF}/4$, ..., $V_{REF}/65,536$), and the control logic acts to bring the comparator back into a balanced condition. The state of the comparator is recorded for each bit trial to produce the resulting conversion result. The conversion phase terminates when all bit trials are complete and the conversion result is ready.

The SAR ADC core generates one output code for each conversion phase. Multiple output codes are averaged together to generate an oversampled ADC result when the active channel is configured with an OSR setting greater than 1 (see the [Transfer Function](#) section and [Oversampling and Decimation](#) section).

The conversion time specification ($t_{CONVERT}$) in [Table 2](#) refers to the delay between a CNV rising edge and the end of the conversion phase. During the conversion phase, the ADC generates a busy indicator to communicate to the digital host when a conversion is complete and ready to be read via the SPI (see the [Busy Indicator](#)

section). When enabled, the busy indicator transitions high at the start of the conversion phase, and transitions low at the end of the conversion phase.

The delay between the end of each acquisition phase and the beginning of the following acquisition phase depends on the channel sequencing mode selected. When two-cycle command mode, the standard sequencer, or the advanced sequencer are enabled, the internal control logic determines the timing of the start of the next acquisition phase. When single-cycle command mode is enabled, the ADC core cannot enter the acquisition phase until the 5-bit channel command is received over the SPI (see the [Single-Cycle Command Mode](#) section).

The minimum acquisition time specification (t_{ACQ}) in [Table 2](#) indicates the minimum amount of time that the AD4695/AD4696 are in the acquisition phase when running at the maximum sample rate.

When analog input high-Z mode is disabled, the switches that connect the analog inputs to the capacitor arrays close immediately at the start of the acquisition phase. When analog input high-Z mode is enabled, these switches close partway through the acquisition phase, but the resulting voltage kickback is significantly reduced. As a result, the settling time and bandwidth requirements of the analog front-end circuitry are reduced when analog input high-Z mode is enabled (see [Figure 21](#) and the [Signal Settling Requirements](#) section).

The AD4695/AD4696 ADC core is controlled by an internal clock, and the SPI serial clock (SCK) is not required for the conversion process.

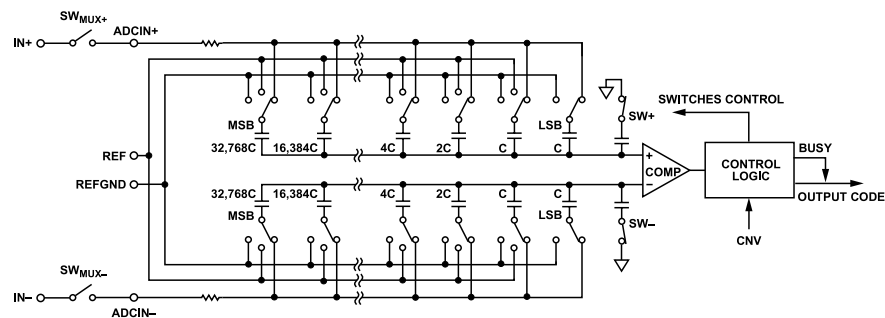

Figure 63. ADC Simplified Schematic

THEORY OF OPERATION

TRANSFER FUNCTION

Figure 64 shows the AD4695/AD4696 data processing path. The SAR ADC core generates one 16-bit output code per conversion period. The OSR setting for the selected analog input channel determines how many consecutive 16-bit output code results are averaged, and then the offset and gain correction settings are applied to generate the final result to be read over the SPI in conversion mode (see the [Oversampling and Decimation](#) section and the [Offset and Gain Correction](#) section).

The conversion result length is determined by the OSR setting. The conversion result resolution can range from 16 bits to 19 bits for an OSR of 1 and 64, respectively (see the [Oversampling and Decimation](#) section).

The conversion result encoding format is determined by the selected polarity mode. The results are in straight binary format for channels configured in unipolar mode, and twos complement

for channels configured in pseudobipolar mode (see the [Channel Configuration Options](#) section).

The AD4695/AD4696 include offset and gain correction for each channel that can be configured to compensate for first-order system errors. The offset and gain correction registers modify the ADC transfer function digitally (see the [Offset and Gain Correction](#) section).

The ideal transfer function is shown in Figure 65. The [Converting Between Codes and Volts](#) section describes the relationship between output codes and input voltages vs. V_{REF} , OSR, polarity modes, and offset and gain correction settings. Table 9 through Table 12 show examples of different voltage inputs and the corresponding results for each OSR and polarity mode option (assuming an ideal ADC transfer function and with the offset and gain correction values set to default values).

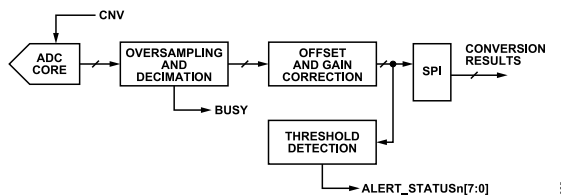

Figure 64. ADC Data Processing Path

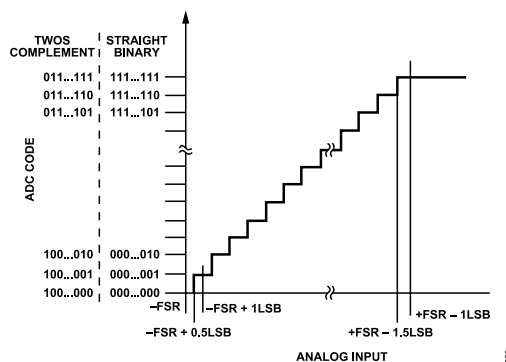

Figure 65. ADC Ideal Transfer Function (FSR Is Full-Scale Range)

Table 9. Output Codes and Ideal Input Voltages, $V_{REF} = 5\text{ V}$, OSR = 1

Description	Input Voltage in Unipolar Mode	Digital Output Code (Straight Binary)	Input Voltage in Pseudobipolar Mode	Digital Output Code (Twos Complement)
FSR - 1 LSB	4.999924 V	0xFFFF	2.499924 V	0x7FFF
Midscale + 1 LSB	2.500076 V	0x8001	76.3 μV	0x0001
Midscale	2.5 V	0x8000	0 V	0x0000
Midscale - 1 LSB	2.499924 V	0x7FFF	-76.3 μV	0xFFFF
-FSR + 1 LSB	76.3 μV	0x0001	-2.499924 V	0x8001
-FSR	0 V	0x0000	-2.5 V	0x8000

THEORY OF OPERATION

Table 10. Output Codes and Ideal Input Voltages, $V_{REF} = 5\text{ V}$, $OSR = 4$

Description	Input Voltage in Unipolar Mode	Digital Output Code (Straight Binary)	Input Voltage in Pseudobipolar Mode	Digital Output Code (Twos Complement)
FSR – 1 LSB	4.999962 V	0x1FFFF	2.499962 V	0x0FFFF
Midscale + 1 LSB	2.500038 V	0x10001	38.1 μV	0x00001
Midscale	2.5 V	0x10000	0 V	0x00000
Midscale – 1 LSB	2.499962 V	0x0FFFF	–38.1 μV	0x1FFFF
–FSR + 1 LSB	38.1 μV	0x00001	–2.499962 V	0x10001
–FSR	0 V	0x00000	–2.5 V	0x10000

Table 11. Output Codes and Ideal Input Voltages, $V_{REF} = 5\text{ V}$, $OSR = 16$

Description	Input Voltage in Unipolar Mode	Digital Output Code (Straight Binary)	Input Voltage in Pseudobipolar Mode	Digital Output Code (Twos Complement)
FSR – 1 LSB	4.999981 V	0x3FFFF	2.499981 V	0x1FFFF
Midscale + 1 LSB	2.500019 V	0x20001	19.1 μV	0x00001
Midscale	2.5 V	0x20000	0 V	0x00000
Midscale – 1 LSB	2.499981 V	0x1FFFF	–19.1 μV	0x3FFFF
–FSR + 1 LSB	19.1 μV	0x00001	–2.499981 V	0x20001
–FSR	0 V	0x00000	–2.5 V	0x20000

Table 12. Output Codes and Ideal Input Voltages, $V_{REF} = 5\text{ V}$, $OSR = 64$

Description	Input Voltage in Unipolar Mode	Digital Output Code (Straight Binary)	Input Voltage in Pseudobipolar Mode	Digital Output Code (Twos Complement)
FSR – 1 LSB	4.999910 V	0x7FFFF	2.499910 V	0x3FFFF
Midscale + 1 LSB	2.500010 V	0x40001	9.54 μV	0x00001
Midscale	2.5 V	0x40000	0 V	0x00000
Midscale – 1 LSB	2.499990 V	0x3FFFF	–9.54 μV	0x7FFFF
–FSR + 1 LSB	9.54 μV	0x00001	–2.499990 V	0x40001
–FSR	0 V	0x00000	–2.5 V	0x40000

THEORY OF OPERATION

ANALOG INPUTS

Figure 66 shows an equivalent circuit of the AD4695/AD4696 analog inputs (IN0 to IN15 and COM).

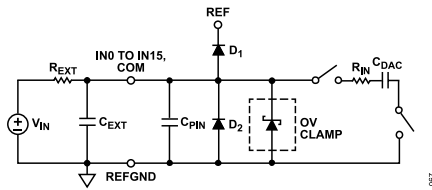

Figure 66. Equivalent Analog Input Circuit

A low crosstalk analog multiplexer routes the signals from the analog input pins to the ADC core inputs. The impedance of the analog inputs is modeled as the parallel combination of the pin capacitance (C_{PIN}) and the network formed by the series connection of R_{IN} and C_{DAC} . R_{IN} represents the ADC input series resistance and the multiplexer switch resistance and is typically 240 Ω . C_{DAC} represents the ADC sampling capacitive DAC shown in Figure 63, and is typically 60 pF.

Each analog input has a unique overvoltage protection clamp circuit, represented by OV CLAMP in Figure 66. The clamps protect the analog inputs from dc overvoltage conditions and eliminate the need for additional external protection diodes. See the [Input Overvoltage Protection Clamps](#) section for a detailed description of the overvoltage protection clamps.

R_{EXT} and C_{EXT} in Figure 66 represent an external, RC low-pass filter, which is included in the system design to limit the bandwidth of the input signal. R_{EXT} can also be used to improve overvoltage protection of the analog inputs. See the [External RC Filter](#) section for detailed descriptions of the R_{EXT} and C_{EXT} functions.

Multiplexer

The AD4695/AD4696 contain a flexible, low crosstalk analog multiplexer for selecting from the 16 analog inputs and internal temperature sensor and routing them to the inputs of the 16-bit, pseudo differential SAR ADC core. Figure 67 shows a simplified schematic of the internal multiplexer. The SW_{MUX+} and SW_{MUX-} switches shown in Figure 63 and Figure 67 represent the multiplexer switches that route the selected channel to the ADC inputs (labeled $ADCIN+$ and $ADCIN-$ in Figure 63). SW_{MUX+} and SW_{MUX-} are break-before-make and are controlled by the internal channel sequencing logic (see the [Channel Sequencing Modes](#) section).

The multiplexer allows flexible analog input channel configuration. The SW_{MUX-} position is user programmable, and can be assigned to any of the pins shown in Figure 67 (see the [Channel Configuration Options](#) section).

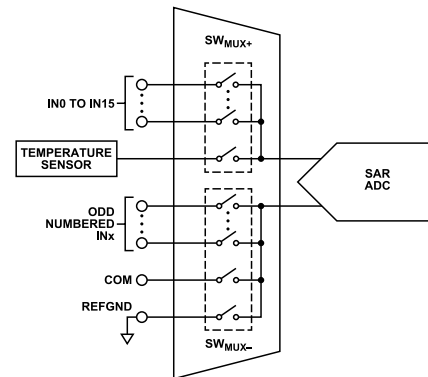

Figure 67. Multiplexer Simplified Schematic

Channel Configuration Options

The AD4695/AD4696 feature several channel configuration options that allow the device to interface with a variety of signals. The channel configuration can be independently programmed for each of the 16 analog inputs (IN0 through IN15).

The channel configuration settings include pin pairing assignments and signal polarity modes. The pin pairing options assign the position of SW_{MUX-} for each position of SW_{MUX+} and determine which signal is routed to the negative side of the SAR ADC core ($ADCIN-$ in Figure 63). The signal polarity modes configure the $ADCIN-$ voltage range. Figure 68 shows the pin pairing and voltage ranges for the different channel configuration options.

The pin pairing assignment options include the following:

- ▶ Figure 68, IN0 to IN15 paired with REFVND
- ▶ Figure 69, IN0 to IN15 paired with COM
- ▶ Figure 70, even numbered input paired with the next highest odd numbered input (for example, IN0 with IN1, IN2 with IN3, and so on).

The two signal polarity modes are called unipolar mode and pseudobipolar mode. When a channel is in unipolar mode, the signal routed to $ADCIN-$ is nominally 0 V (relative to REFVND). When a channel is in pseudobipolar mode, the signal routed to $ADCIN-$ is nominally $V_{REF}/2$ V (relative to REFVND). The valid operating input voltage specification for unipolar and pseudobipolar modes are shown in Table 1.

When an input is configured in unipolar mode, its output codes are in straight binary format. When an input is configured in pseudobipolar mode, its output codes are in twos complement format. See the [Transfer Function](#) section for an example of the output code formatting for both unipolar and pseudobipolar modes.

The pin pairing assignments are selected with the IN_PAIR bit field in the $CONFIG_INn$ registers. The signal polarity modes are selected with the IN_MODE field in the $CONFIG_INn$ registers.

When an even numbered input is paired with its corresponding odd numbered input, selecting the odd numbered input through

THEORY OF OPERATION

any of the channel sequencing modes is functionally identical to selecting the even numbered input. The even numbered input is always connected to ADCIN+, the odd numbered input is always connected to ADCIN-, and only the settings in the even numbered input CONFIG_INn register are applied. It is recommended to only include the even numbered input in the channel sequence when the input is assigned as part of a channel pair.

When the standard sequencer is enabled, the pin pairing assignment settings are the same for all 16 analog inputs and are set by the IN_PAIR field in the CONFIG_IN0 register. When the advanced sequencer, two-cycle command mode, or single-cycle command mode is enabled, the pin pairing assignment settings are independent for all 16 analog inputs and are set by the IN_PAIR field in the corresponding CONFIG_INn register for each input. The polarity mode settings for each analog input are always set by the IN_MODE bits in the corresponding CONFIG_INn registers, regardless of the channel sequencing mode.

Note that pseudobipolar mode is not available for channels with the REFGND pin pairing assignment selected. If a channel pin pairing assignment is configured as REFGND, the state of the IN_PAIR field is ignored.

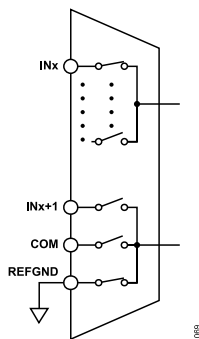

Figure 68. INx Paired with REFGND

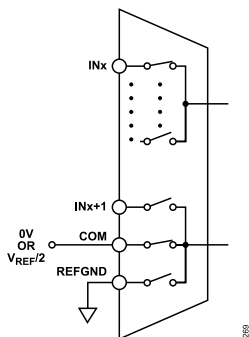

Figure 69. INx Paired with COM

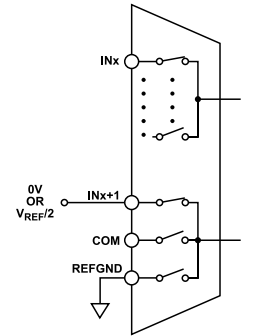

Figure 70. Even- and Odd-Channel Paired

Analog Input High-Z Mode

To achieve optimal data sheet performance from traditional high resolution multiplexed SAR ADCs, system designers must often include dedicated, high bandwidth, low noise ADC driver amplifiers between the analog signal conditioning circuitry and the ADC inputs to settle the voltage kickback that occurs at the analog inputs between conversions. The AD4695/AD4696 analog input high-Z mode simplifies the design requirements of the AFE circuitry that drives the analog inputs and facilitates the design of small footprint, high channel density, precision multiplexed SAR ADC signal chains.

Analog input high-Z mode significantly reduces the magnitude of the voltage kickback that occurs at the analog inputs when the ADC and multiplexer switches reconnect at the start of the ADC acquisition phase (see the [Signal Settling Requirements](#) section). [Figure 21](#) shows the voltage kickback that occurs on an analog input driven to 5 V after switching from another analog input driven to 0 V with analog input high-Z mode disabled and enabled.

The reduction in the voltage kickback increases the effective input impedance of the AD4695/AD4696 analog inputs and reduces the bandwidth requirements of the AFE circuitry to achieve desired settling accuracy and performance. The relaxed bandwidth requirements of the AD4695/AD4696 simplify the AFE circuit design by broadening the selection of compatible amplifiers and external RC filter components. Therefore, analog input high-Z mode helps remove the requirement of dedicated ADC driver amplifiers per channel, which significantly reduces system footprint and power consumption.

The analog input high-Z mode also reduces performance degradation caused by series resistance between the front-end amplifiers and the AD4695/AD4696 analog inputs, which allows the resistor in the external RC filter (shown as R_{EXT} in [Figure 66](#) and [Figure 112](#)) to be larger compared to traditional multiplexed SAR ADCs. Using larger R_{EXT} with smaller C_{EXT} alleviates amplifier stability concerns without significantly impacting distortion performance.

[Figure 71](#) and [Figure 72](#) demonstrate how a lower power, lower bandwidth amplifier ([ADA4077-1](#)) can achieve the same ac performance as a lower noise, higher bandwidth ADC driver amplifier ([ADA4807-1](#)) by utilizing the AD4695/AD4696 analog input

THEORY OF OPERATION

high-Z mode. Figure 71 and Figure 72 show the SNR and THD performance of the AD4695/AD4696 paired with the ADA4077-1 and ADA4807-1 with various external RC filter components with analog input high-Z mode disabled and enabled. Figure 73 shows the circuit configuration used to measure the performance metrics shown in Figure 71 and Figure 72. The standard sequencer is configured to alternate between two AD4695/AD4696 channels once per conversion. The channels are driven by antiphase, full-scale, 1 kHz sine waves.

The ADA4807-1 is a low noise, high bandwidth amplifier that is typically recommended for driving precision SAR ADCs, and the ADA4077-1 is a high precision, low drift amplifier with a comparably lower bandwidth. Table 13 shows the -3 dB bandwidth, input voltage noise, and supply current per amplifier specifications for the ADA4807-1 and ADA4077-1. When analog input high-Z mode is disabled, the ADA4077-1 THD performance is degraded because of its inability to settle the voltage kickback between conversions. When analog input high-Z mode is enabled, the ADA4077-1 is able to achieve similar THD performance to the ADA4807-1, despite having a comparably lower bandwidth. In the example shown in Figure 73, analog input high-Z mode removes the need for an ADA4807-1 or equivalent ADC driver amplifier for each of its 16 analog input channels, which reduces the standby current consumption of the system by roughly 16 mA, and drastically reduces the full solution footprint.

Table 26 provides a list of recommended companion amplifiers and external RC filter components to pair with the AD4695/AD4696 for different target sample rates and input signal bandwidths.

Analog input high-Z mode is enabled with the AINHIZ_EN bit in the CONFIG_INn registers. When the standard sequencer is enabled, analog input high-Z mode is enabled or disabled for all 16 analog inputs and is set by the AINHIZ_EN bit in the CONFIG_IN0 register. When the advanced sequencer is enabled, or when using two-cycle command mode or single-cycle command mode, analog input high-Z mode is enabled or disabled for all 16 analog inputs independently and is set by the AINHIZ_EN bit in the corresponding CONFIG_INn register for each input. Analog input high-Z mode is always enabled when sampling the temperature sensor.

Analog input high-Z mode must be enabled when reference input high-Z mode is enabled. If any analog input channels are config-

ured with analog input high-Z mode disabled, the reference input high-Z mode must also be disabled.

Table 13. Companion Amplifier Specifications

Amplifier	Input Voltage Noise	-3dB Bandwidth	Supply Current per Amplifier
ADA4807-1/ ADA4807-2/ ADA4807-4	3.1 nV/ $\sqrt{\text{Hz}}$	180 MHz	1.0 mA
ADA4077-1/ ADA4077-2/ ADA4077-4	6.9 nV/ $\sqrt{\text{Hz}}$	5.9 MHz	400 μA

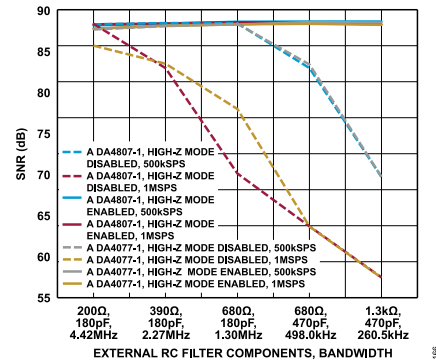

Figure 71. SNR vs. External RC Filter Components, Bandwidth for Various Amplifiers ($V_{REF} = 5\text{ V}$, $f_{IN} = 1\text{ kHz}$)

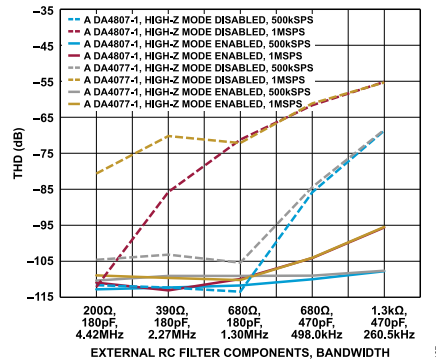

Figure 72. THD vs. External RC Filter Components, Bandwidth for Various Amplifiers ($V_{REF} = 5\text{ V}$, $f_{IN} = 1\text{ kHz}$)

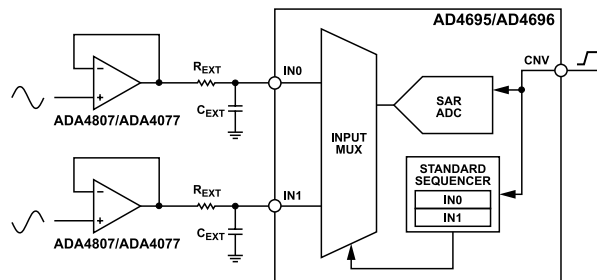

Figure 73. Amplifier and RC Filter Performance vs. Analog Input High-Z Mode Test Circuit

THEORY OF OPERATION

INPUT OVERVOLTAGE PROTECTION CLAMPS

The AD4695/AD4696 include overvoltage protection clamps on IN0 to IN15 and COM to reduce the risk of device damage from sustained dc overvoltage events. These clamps eliminate the need for external clamping diodes in systems where the input driving circuitry positive supply rail is greater than V_{REF} (see [Figure 112](#)).

[Table 1](#) shows the activation, deactivation, and clamping voltages of the overvoltage protection clamps. [Figure 36](#) and [Figure 39](#) show typical behavior of the clamps during overvoltage conditions. The clamp circuits activate when the analog input voltage exceeds the activation voltage. The clamps deactivate when the input voltage drops below the deactivation voltage. While a clamp is active, a flag is set in the status registers that can be read by the digital host. See the [Overvoltage Clamp Flags](#) section for a detailed description of the options for reading the status of each clamp.

The overvoltage protection clamps limit the extent to which input overvoltage events disturb the reference source. When active, the clamps limit the voltage on the analog inputs to the specified clamping voltage and conduct the input current to ground rather than through the ESD diode connecting the analog input to the REF input (D_1 in [Figure 66](#)), which prevents overvoltage conditions on one analog input from degrading performance on other analog inputs or other devices sharing the reference. [Figure 43](#) shows the relationship between a single clamp input current and the resulting additional reference input current.

[Figure 24](#), [Figure 27](#), and [Figure 31](#) through [Figure 33](#) show the offset error, gain error, and ac performance for one analog input channel vs. the total number of active overvoltage protection clamps on the other inputs.

Each overvoltage protection clamp circuit supports a maximum sustained current of 5 mA. All 17 clamp circuits can sink 5 mA simultaneously without damaging the device. The clamp current is a function of V_{REF} , the external series resistance (such as R_{EXT} in [Figure 66](#)), and the output voltage of the AFE circuitry. See the [Input Overvoltage Protection Clamps](#) section for details on how to select R_{EXT} to prevent excess clamp current during overvoltage events.

Overvoltage Reduced Current Mode

The overvoltage reduced current mode further reduces the additional reference current during overvoltage events. [Figure 43](#) shows the difference between the additional reference input currents drawn for different clamp input currents with the overvoltage reduced current mode enabled and disabled.

The overvoltage reduced current mode is enabled when the OV_MODE bit in the REF_CTRL register is set to 0. Overvoltage reduced current mode is enabled by default.

Enabling overvoltage reduced current mode changes the maximum allowable value of R_{EXT} for ensuring stable clamp operation. See the [Overvoltage Protection Clamp Stability](#) section for more information

on the relationship between the external RC filter and clamp operation.

Overvoltage Protection Clamp Stability

In applications where analog input overvoltage events are not a concern, or in applications where clamp stability is not a concern, the R_{EXT} and C_{EXT} values are not required to follow the guidelines described in this section.

The stability of the overvoltage protection clamp circuits depends on the external RC filter component values and whether the overvoltage reduced current mode is enabled or disabled. When a clamp is unstable, it toggles between the active and inactive states during overvoltage events. This instability causes small, modulating currents to flow in both the overdriven input and the reference, which can result in measurement errors in the conversions of other analog inputs if the reference circuitry does not have adequate load regulation to maintain a stable reference voltage in response to the additional reference current. [Table 1](#) and [Figure 43](#) show the additional reference input (REF) current per active clamp.

To ensure stable clamp operation, C_{EXT} in the external RC filter (as shown in [Figure 66](#)) must be at least 500 pF. The maximum value of R_{EXT} is 1 k Ω when the overvoltage reduced current mode is enabled, and 2 k Ω when the overvoltage reduced current mode is disabled.

Overvoltage Clamp Flags

The AD4695/AD4696 provide several means to check the status of the overvoltage protection clamps.

The INX_CLAMP_FLAG bits in the $CLAMP_STATUS1$ and $CLAMP_STATUS2$ registers indicate the status of the overvoltage protection clamps for IN0 to IN15. Each INX_CLAMP_FLAG bit is asserted when the corresponding input clamp circuit is active and is deasserted when the corresponding input clamp circuit is inactive. The $CLAMP_FLAG$ bit in the status register is asserted when any combination of the overvoltage clamps on IN0 to IN15 are activated (when any of the INX_CLAMP_FLAG bits are asserted). This bit is sticky and is only cleared when it is read while all clamps are inactive.

The COM_CLAMP_FLAG bit in the status register is asserted when the \overline{COM} input overvoltage protection clamp is active and is deasserted when the \overline{COM} input overvoltage protection clamp is inactive. These bits can be read when in register configuration mode to check the current status of each of the overvoltage input clamp circuits.

The OV_ALT flag in the optional status bits allows all overvoltage clamp statuses to be checked while performing conversions. The OV_ALT flag is the bitwise logical OR of the 16 INX_CLAMP_FLAG bits in the $CLAMP_STATUS1$ and $CLAMP_STATUS2$ registers. The OV_ALT flag can also be configured as the logical OR of the overvoltage clamp flags and the general threshold alert indicator (as

THEORY OF OPERATION

described in the [Threshold Detection and Alert Indicators](#) section). See the [Status Bits](#) section for details on configuring the OV_ALT flag.

TEMPERATURE SENSOR

The AD4695/AD4696 include a temperature sensor that converts the die temperature to an output voltage that can be sampled and converted to an output code by the SAR ADC core. The relationship between the measured die temperature (T) and the temperature sensor output voltage (V_{TEMP}) is nominally

$$V_{TEMP} = \left(-1.8 \frac{\text{mV}}{^{\circ}\text{C}} \times T\right) + 725 \text{ mV} \quad (2)$$

V_{TEMP} is converted to a 16-bit output code (C_{TEMP}) by the ADC with the same transfer function as the analog inputs. V_{TEMP} is calculated from C_{TEMP} with the following equation:

$$V_{TEMP} = C_{TEMP} \times \frac{V_{REF}}{2^{16}} \quad (3)$$

Conversely, measured die temperature (T) is calculated from V_{TEMP} with the following equation:

$$T = \frac{V_{TEMP} - 725\text{mV}}{-1.8 \text{ mV}/^{\circ}\text{C}} \quad (4)$$

The temperature sensor sensitivity is a measure of the change in output voltage in relation to a change in device temperature, and is typically $-1.8 \text{ mV}/^{\circ}\text{C}$. At 0°C , the temperature sensor output is typically 725 mV. The typical range for V_{TEMP} is therefore 797 mV to 500 mV across a -40°C to 125°C temperature range.

When the temperature sensor is selected, the multiplexer $\text{SW}_{\text{MUX}+}$ switch (see [Figure 67](#)) selects the temperature sensor output and its $\text{SW}_{\text{MUX}-}$ switch selects REF_GND, and the SAR ADC core samples V_{TEMP} to generate a corresponding output code. The analog-to-digital conversion of the temperature sensor output utilizes the same transfer function as an analog input configured in unipolar mode with $\text{OSR} = 1$ (see the [Transfer Function](#) section).

When the standard sequencer or advanced sequencer is enabled, the temperature sensor is sampled at the end of the preprogrammed channel sequence if the TEMP_EN bit in the TEMP_CTRL register is set to 1.

When using either two-cycle command mode or single-cycle command mode, the temperature sensor can be selected by writing the code 0x0F on SDI on the first five rising edges of SCK in the same way analog inputs are selected (see [Table 18](#)).

When the temperature sensor is enabled, analog input high-Z mode is always enabled and the OSR is always 1. The temperature sensor does not have threshold detection alerts.

VOLTAGE REFERENCE INPUT

V_{REF} sets the ADC full-scale voltage (see the [Transfer Function](#) section). The ADC core samples the voltage on the reference input (REF) during the bit trials in the conversion process to determine

the output code result. The AD4695/AD4696 are compatible with reference voltages from 2.4 V to 5.1 V.

The AD4695/AD4696 must be configured for optimal performance with the selected reference voltage. The VREF_SET bit field in the REF_CTRL register provides five V_{REF} range options, as shown in [Table 49](#). This value must be programmed to match the V_{REF} voltage applied to the REF pin.

A common challenge presented by traditional SAR ADCs is in designing reference circuitry with sufficient drive capability to maintain a precise V_{REF} while the REF input dynamically draws input current during the SAR bit trials. Deviations in V_{REF} result in reduction in ADC accuracy and performance, such as higher gain error or distortion. The REF input presents a dynamic load as the input pulls charge from the external reference circuitry at different times in the SAR process. This process traditionally requires either voltage references with sufficient load regulation and drive capabilities, or the use of a dedicated reference buffer to drive the REF input with a large reference decoupling capacitor. See the [Reference Circuitry Design](#) section for more information on properly selecting reference circuitry components.

The AD4695/AD4696 incorporate features that simplify design of the companion reference circuitry, and facilitate the design of small footprint, low power systems. The reference input high-Z mode reduces the REF input current by approximately 95%, allowing a broader selection of voltage references and amplifiers to drive the REF input without impacting performance (see the [Reference Input High-Z Mode](#) section). The internal reference buffer (available in the WLCSP option only) also provides a true buffered reference input (see the [Internal Reference Buffer](#) section).

The average REF input current scales with sample rate (see [Table 1](#) and [Figure 40](#)).

Reference Input High-Z Mode

When enabled, reference input high-Z mode reduces the average REF current by approximately 95% from $320 \mu\text{A}/\text{MSPS}$ to $11 \mu\text{A}/\text{MSPS}$ (see [Table 1](#)). The reduction in REF current allows the AD4695/AD4696 to tolerate larger series resistance between the reference source and the REF input without compromising performance. Therefore, reference input high-Z mode allows voltage references with higher load regulation specifications to directly drive the REF input without the need for a dedicated reference buffer.

The REF input requires a reference decoupling capacitor (C_{REF}). When reference input high-Z mode is disabled, C_{REF} must be $10 \mu\text{F}$ or larger. When reference input high-Z mode is enabled, C_{REF} can be as small as $1 \mu\text{F}$.

See the [Reference Circuitry Design](#) section for more reference circuit design recommendations.

To enable and disable reference input high-Z mode, set the value of the REFHIZ_EN bit in the REF_CTRL register. Reference input high-Z mode is enabled by default.

THEORY OF OPERATION

Analog input high-Z mode must be enabled when reference input high-Z mode is enabled. If any analog input channels are configured with analog input high-Z mode disabled, reference input high-Z mode must also be disabled.

Internal Reference Buffer

The internal reference buffer (available only in the WLCSP option of the AD4695/AD4696) provides a true buffered reference input (REFIN). The internal reference buffer is useful in applications using unbuffered, low power reference sources, or where multiple devices share a common reference source. As described in the [Reference Circuit Design for Internal Reference Buffer](#) section, an RC low-pass filter with a very low cutoff frequency can be implemented at the internal reference buffer input to significantly reduce wideband noise from the reference source.

When the internal reference buffer is enabled, the maximum allowable V_{REF} is $AVDD - 0.3\text{ V}$ (see [Table 1](#)).

When not using the internal reference buffer, REFIN must be tied to REF.

When the internal reference buffer is enabled, the AD4695/AD4696 draw approximately 450 μA more current through the AVDD supply; however, this is still typically less additional supply current when compared to a dedicated external reference buffer that is traditionally required to drive the reference input of a SAR ADC. [Table 1](#) shows power consumption with the internal reference buffer disabled and enabled.

[Figure 74](#) shows a simplified diagram of the AD4695/AD4696 internal reference buffer. The internal reference buffer is enabled by setting the REFBUF_EN bit in the REF_CTRL register to 1. The reference input high-Z mode must be enabled when using the internal reference buffer (REFHIZ_EN = 1). The internal reference buffer is disabled by default.

When the internal reference buffer is disabled, setting the REFBUF_BP bit in the REF_CTRL register bypasses the internal reference buffer by internally connecting the REFIN and REF pins (via SW_{BP}). When the internal reference buffer is enabled (REFBUF_EN = 1), the value of the REFBUF_BP bit is ignored and SW_{BP} is always open. Do not operate the AD4695/AD4696 in conversion mode while the REFBUF_BP bit is set to 1.

The internal reference buffer turn-on time specification (t_{REFBUF} in [Table 1](#)) is the delay between enabling the internal reference buffer and the REF pin voltage transitioning from 0 V to V_{REF} within 0.01%. t_{REFBUF} is proportional to the REF decoupling capacitor (C_{REF}). The internal reference buffer includes a boost mode, which reduces the internal reference buffer turn-on time when it is enabled by increasing the internal reference buffer output current (see the [Optimizing Reference Buffer Startup](#) section). Set the REFBUF_BOOST bit in the REF_CTRL register to 1 to enable reference buffer boost mode. Reference buffer boost mode is disabled by default.

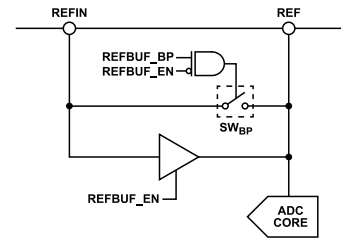

Figure 74. Internal Reference Buffer Simplified Schematic

POWER SUPPLIES

The AD4695/AD4696 have three power supply pins: an analog supply (AVDD), an ADC core supply (VDD), and a digital input/output interface supply (VIO). The AD4695/AD4696 also include an internal LDO that can be used to provide the VDD rail with a wider variety of supply voltages (or in single-supply systems by tying LDO_IN to AVDD). [Table 1](#) shows the specified power supply voltage requirements.

AVDD can range from 3.15 V to 5.5 V and powers the analog front-end features of the AD4695/AD4696, including the multiplexer, analog input high-Z mode and reference input high-Z mode circuitry, and the internal reference buffer (WLCSP option only). When the internal reference buffer is disabled and the REF input is driven directly, AVDD can be as low as $REF - 0.25\text{ V}$. When the internal reference buffer is enabled and V_{REF} is provided on REFIN, AVDD must be at least $REFIN + 0.3\text{ V}$ (see [Table 1](#)).

VDD is nominally 1.8 V, and powers both the ADC core and the device register memory. When power is first applied to VDD, the ADC core initializes and the device register contents are set to the default states (as shown in the [Register Information](#) section).

VIO can range from 1.14 V to 1.98 V and sets the input and output levels for the digital interface pins. VIO allows direct interfacing with digital controller logic levels between 1.2 V and 1.8 V (see the [Digital Interface](#) section for more information).

Decouple AVDD, LDO_IN, and VDD to AGND and VIO to IOGND with at least 100 nF. When shorting AVDD and LDO_IN, a single decoupling capacitor can be used for both pins. When not using the internal LDO, LDO_IN does not require decoupling.

As described in the [Internal LDO](#) section, the internal LDO requires a decoupling capacitor of at least 100 nF on the VDD pin for proper device operation.

The AD4695/AD4696 are independent of the power supply sequencing between VIO, VDD, and AVDD (and LDO_IN when the internal LDO is enabled). When VIO and VDD are first supplied, a power-on reset (POR) initiates (see the [Device Reset](#) section). Additionally, the AD4695/AD4696 are insensitive to power supply ripple over a wide frequency range, as shown in [Figure 35](#).

THEORY OF OPERATION

Internal LDO

To minimize the number of system supply rails required to power the AD4695/AD4696, the internal LDO can be used to supply the VDD voltage internally. LDO_IN can be tied to AVDD to enable a single supply to power the entire device (excluding VIO, which must be powered by the digital host input/output voltage).

To enable the internal LDO, LDO_IN must be driven to at least 2.4 V and VIO must already be powered. To enable the internal LDO, set the LDO_EN bit in the setup register to 1. The internal LDO is enabled by default on device power-up and after device resets.

The output of the internal LDO is connected to the VDD pin. When the internal LDO is enabled, its output drives VDD internally. When the internal LDO is disabled, its output is disabled and high impedance.

The internal LDO requires an output decoupling capacitor. When using the internal LDO, include a 100 nF to 10 μ F decoupling capacitor between the VDD and AGND pins, as pictured in [Figure 112](#).

It is not possible to power the VIO supply with the internal LDO output. VIO must be supplied by the digital host or other system supply rail.

When using the internal LDO, the VDD supply voltage is driven by the internal LDO output automatically when LDO_IN and VIO are supplied. When not using the internal LDO, LDO_IN must be tied to AGND and VDD must be supplied externally.

The internal LDO output is designed to withstand being powered up with VDD either driven by a separate 1.8 V supply or inadvertently shorted to AGND. Ensure that the VDD pin is disconnected from any other rails or loads. The internal LDO is not intended to power additional devices. Clear the LDO_EN bit of the SETUP register when powering VDD externally, even if the LDO_IN input is shorted to AGND (see the [Device Configuration Recommendations](#) section).

The internal LDO can be disabled to put the AD4695/AD4696 in a low power state without disabling the AVDD, LDO_IN, or VIO rails. When the internal LDO is disabled while VDD is not powered by an external supply, the ADC core shuts down and the configuration register contents are erased. The internal LDO can be enabled again either with a wake-up command over the SPI, or with a hardware reset. The wake-up command is 0x81 and is identical to performing a software reset (see the [Device Reset](#) section for detailed descriptions of hardware and software resets). The digital interface requires that VIO still be supplied to accept the wake-up command, and the internal LDO is not enabled if VIO is not within the specified range (see [Table 1](#)).

OVERSAMPLING AND DECIMATION

The AD4695/AD4696 include an oversampling and decimation engine that averages consecutive ADC samples to generate an oversampled result with higher effective resolution and lower effective noise (see [Table 1](#)).

Each analog input channel can be configured with an OSR of 1, 4, 16, or 64. Conversion results generated for channels with an OSR of 4, 16, or 64 are 17 bits, 18 bits, or 19 bits long, as shown in [Table 21](#) and [Table 22](#) and the [Transfer Function](#) section.

When a given analog input channel is selected by the channel sequencing logic, the multiplexer continues to select that channel until the specified number of conversions have been performed, and the results of each of those conversions are averaged together to generate a single output code. For example, if IN0 is configured with an OSR of 64, one averaged result is produced after the 64th consecutive CNV rising edge (when the AD4695/AD4696 are in conversion mode). Configuring a channel with an OSR of 1 is equivalent to performing no oversampling on that channel.

When enabled on the BSY_ALT_GP0 pin or the serial data output(s), the busy indicator acts as a data ready signal, and only transitions low when the oversampled result is available (see the [Busy Indicator](#) section). [Figure 78](#) shows the relative timing of the busy indicator when the OSR for a channel is set to a value other than 1.

The effective sample period of a given channel is equal to the conversion period (t_{CYC}) in [Table 2](#) multiplied by its OSR. [Figure 78](#) shows the relative timing of the CNV signal and the availability of the oversampled result. Consider the OSR of each channel when designing the channel sequence to achieve the desired certain effective sample rates for each channel (see the [Effective Channel Sample Rate](#) section).

The OSR is configured via the OSR_SET bit fields in the CONFIG_INn registers (see [Table 57](#)).

When the standard sequencer is enabled, the OSR for all analog input channels is the same and is set by the OSR_SET bit field in the CONFIG_IN0 register. When the advanced sequencer is enabled, each of the 16 analog input channels can be configured with different OSR settings with the OSR_SET bit fields in the corresponding CONFIG_INn registers.

Oversampling is not supported in two-cycle command mode or single-cycle command mode. Set the OSR_SET bit fields for all active channels to 0x0 when using two-cycle command mode or single-cycle command mode.

When autcycle mode is enabled, the conversion signal is generated internally by the AD4695/AD4696, and the oversampling engine continues to wait for OSR conversion periods before generating an output result.

THEORY OF OPERATION

OFFSET AND GAIN CORRECTION

The AD4695/AD4696 include offset and gain error correction functionality to correct for first-order nonidealities in a full AFE signal chain. Offset and gain error correction digitally adjusts the offset and gain of the overall ADC transfer function (see the [Transfer Function](#) section).

The final output code is calculated with the following expression:

$$OUT = (IN + B) \times M \quad (5)$$

where:

OUT is the final output code result.

IN is the result generated by the ADC (after oversampling).

B is the offset correction value.

M is the gain correction value.

The gain correction value (*M*) for each analog input is set with the gain bit field in the corresponding *GAIN_INn* register. The gain bit field is 16 bits wide and is in straight binary format. The range of gain correction values is 0 to 1.99997, and is calculated with the following expression:

$$M = \frac{GAIN}{2^{15}} \quad (6)$$

where *GAIN* is the value written to the gain bit field.

The offset correction value (*B*) for each analog input is set with the offset field in the corresponding *OFFSET_INn* register. The offset bit field is 16 bits wide and is in twos complement format to enable positive and negative offset correction. The range of offset correction values is $\pm FSR/8$ for all OSR options, which means the MSB of the offset bit field always corresponds to the (MSB – 3) bit of the ADC result. For example, when the OSR for a given analog input channel is 1, the offset correction value is equal to offset, Bits[15:3], and when the OSR is 64, the offset correction value is offset, Bits[15:0]. [Table 14](#) shows the offset correction value for each OSR option.

Offset and gain correction are always enabled for all analog input channels. When the offset bit field for a given analog input is set to 0x0000, the offset correction value is 0 and is equivalent to applying no offset correction. When the gain bit field for a given analog input is set to 0x8000, the gain correction value is 1 and is equivalent to applying no gain correction.

Table 14. Oversample Ratio vs. Offset Correction Value

Oversample Ratio	Offset Correction Value (B)
1	Offset, Bits[15:3]
4	Offset, Bits[15:2]
16	Offset, Bits[15:1]
64	Offset, Bits[15:0]

THRESHOLD DETECTION AND ALERT INDICATORS

The AD4695/AD4696 include a threshold detection feature with alert indicators that notify the digital host system when a conversion result violates user defined upper and lower limits.

The *TD_EN* bit in the *CONFIG_INn* registers enables or disables threshold detection for the corresponding analog input. When the standard sequencer is enabled, threshold detection is enabled or disabled for all analog inputs with the *TD_EN* bit in the *CONFIG_IN0* register. When the advanced sequencer, two-cycle command mode, or single-cycle command mode is enabled, threshold detection is enabled or disabled for each analog input independently with the *TD_EN* bit in each of the corresponding *CONFIG_INn* registers.

When threshold detection is enabled for a given analog input, the ADC results generated for that analog input are compared against an upper threshold value and lower threshold value. Upper and lower threshold values can be independently assigned for each of the 16 analog inputs. The upper and lower threshold values for the 16 analog inputs are set with the upper and lower bit fields in the *UPPER_INn* and *LOWER_INn* registers. The upper and lower bit fields are 12 bits wide and correspond to the 12 MSBs of the ADC results for all OSR options. For example, setting the upper bit field to 0xFFF corresponds to an upper threshold value of 0xFFF0 when the OSR of that channel is 1, and 0x7FF80 when the OSR of that channel is 64 (see the [Oversampling and Decimation](#) section).

When an analog input is configured in unipolar mode, the corresponding upper and lower bit fields are in straight binary format. When an analog input is configured in pseudobipolar mode, the corresponding upper and lower bit fields are in twos complement format.

Alert Indicator Registers

The *ALERT_STATUS1* to *ALERT_STATUS4* registers contain the upper alert indicators (*HI_INn*) and lower alert indicators (*LO_INn*) for all 16 analog inputs. The *TD_ALERT* bit in the status register is the logical OR of the *HI_INn* and *LO_INn* bits. When the ADC result is greater than or equal to the upper threshold value, the corresponding *HI_INn* flag is set to 1. When the ADC result is less than or equal to the lower threshold value, the corresponding *LO_INn* flag is set to 1. When the OSR of an *INn* analog input is greater than 1, the state of its corresponding *HI_INn* and *LO_INn* flags update after the oversampled result is generated.

Reading the *TD_ALERT* bit indicates to the digital host whether any upper or lower threshold was violated, and reading the *HI_INn* and *LO_INn* bits indicates which specific type of threshold was violated on which channel. The AD4695/AD4696 must be in register configuration mode to read from the registers that contain these alert indicator bits, but the state of *TD_ALERT* can also be read via the status bits or a general-purpose pin when these options

THEORY OF OPERATION

are enabled (see the [Status Bits](#) section and [Alert Indicator on General-Purpose Pins](#) section).

The HI_INn and LO_INn bits are read to clear bits and are automatically reset to 0 after being read in a SPI read transaction (in register configuration mode).

When the ALERT_MODE bit in the setup register is set to 0, the HI_INn and LO_INn bits also automatically clear based on user programmable hysteresis settings. The HYSTERESIS bit fields in the 16 HYST_INn registers set the hysteresis value for the corresponding analog input. Each analog input can be programmed with different hysteresis values. When this option is selected, each HI_INn bit automatically clears when the corresponding analog input generates a conversion result that is less than the upper threshold value minus the hysteresis value. Each LO_INn bit automatically clears when the corresponding analog input generates a conversion result that is greater than the lower threshold value plus the hysteresis value. [Figure 75](#) shows how the HI_INn and LO_INn bits are set and cleared when ALERT_MODE is set to 0 and 1 as conversion results are generated on the corresponding analog input channel. ALERT_MODE is set to 0 by default.

Alert Indicator on General-Purpose Pins

When the alert indicator is enabled on a general-purpose pin, the state of the TD_ALERT bit is driven on either BSY_ALT_GP0 or GP2, which allows threshold violations to be detected without

interrupting conversions. The combination of the alert indicator on the general-purpose pins and autocycle mode allows the digital host serial interface to remain idle until a threshold violation is detected (see the [Autocycle Mode](#) section).

[Figure 94](#) through [Figure 100](#) show the relative timing of CNV rising edges and when the state of the alert indicator is updated and driven out on the general-purpose pin.

On the WLCSP options of the AD4695/AD4696, the alert indicator can be enabled on either the BSY_ALT_GP0 pin or the GP2 pin. The ALERT_GP_SEL bit in the GP_MODE register selects which of the general-purpose pins is configured as the alert indicator. Set the ALERT_GP_EN bit in the GP_MODE register to 1 to enable the alert indicator on the selected general-purpose pin (see [Table 54](#)).

On the LFCSP option of the AD4695/AD4696, the alert indicator can be enabled only on the BSY_ALT_GP0 pin, and the state of the ALERT_GP_SEL bit has no impact on device behavior. Set the ALERT_GP_EN bit in the GP_MODE register to 1 to enable the busy indicator on BSY_ALT_GP0 (see [Table 54](#)).

The BSY_ALT_GP0 and GP2 pins can also be configured to perform other functions than the alert indicator, and all other higher priority functions must be disabled to configure them as the alert indicator. See the [General-Purpose Pins](#) section for details on configuring the general-purpose pins.

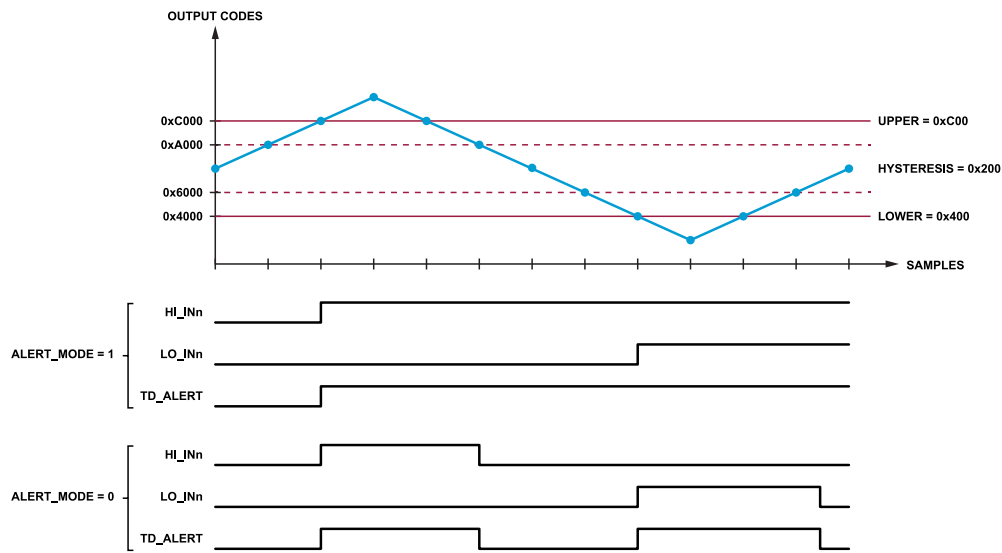

Figure 75. Alert Indicator Behavior with Hysteresis Enabled and Disabled (Unipolar Mode, OSR = 1)

022

THEORY OF OPERATION

BUSY INDICATOR

The busy indicator acts as a data ready signal that can be used to trigger an interrupt service routine on the digital host to initiate an SPI transaction to read the ADC result (see the [Conversion Mode](#) section and [SPI Peripheral Synchronization in Conversion Mode](#) section). The busy indicator can be enabled on the serial data outputs and on some of the general-purpose pins.

Busy Indicator on Serial Data Outputs

When the busy indicator is enabled on the serial data outputs, the serial data outputs are high impedance while the ADC is in the conversion phase, and transition low when the ADC result is ready. Set the SDO_STATE bit in the setup register to 1 to enable the busy indicator on the serial data outputs.

[Figure 94](#) through [Figure 100](#) show the relative timing of CNV rising edges to the busy indicator on the serial data outputs.

The serial data output mode selected by the SDO_MODE bit field determines which pins are assigned as serial data outputs (see the [Serial Data Output Modes](#) section). When SDO_STATE is set to 1, the busy indicator is enabled on all pins assigned as serial data outputs. When single-SDO mode is selected, the busy indicator is only output on SDO. When dual-SDO mode or quad-SDO mode is selected, the busy indicator is also output on the relevant general-purpose pins as indicated in [Table 19](#).

When enabling the busy indicator on the serial data outputs, place pull-up resistors (2 k Ω minimum) on each utilized pin to ensure that the serial data output lines are pulled high until the ADC result is ready.

The serial data outputs are forced to a high impedance state whenever the \overline{CS} pin is driven high. If the \overline{CS} pin is high when the ADC result is ready, the serial data outputs remain high impedance until the \overline{CS} pin is brought low (see the [Digital Interface](#) section).

Busy Indicator on General-Purpose Pins

When the busy indicator is enabled on a general-purpose pin, the selected general-purpose pin is driven high while the ADC is in the conversion phase, and transitions low when the ADC result is ready. Set the BUSY_GP_EN bit in the GP_MODE register to 1 to enable the busy indicator on the selected general-purpose pin.

[Figure 94](#) through [Figure 100](#) show the relative timing of CNV rising edges to the busy indicator rising and falling edges.

On the WLCSP option of the AD4695/AD4696, the busy indicator can be enabled on either the BSY_ALT_GP0 pin or the GP3 pin. The BUSY_GP_SEL bit in the GP_MODE register selects which of the general-purpose pins is configured as the busy indicator. Set the BUSY_GP_EN bit in the GP_MODE register to 1 to enable the busy indicator on the selected general-purpose pin.

On the LFCSP option of the AD4695/AD4696, the busy indicator can be enabled only on the BSY_ALT_GP0 pin, and the state of the BUSY_GP_SEL bit has no impact on device behavior. Set the BUSY_GP_EN bit in the GP_MODE register to 1 to enable the busy indicator on the BSY_ALT_GP0 pin.

When a general-purpose pin is assigned as the busy indicator, it is not forced to high impedance when the \overline{CS} pin is high, which allows the digital host to leave the serial interface completely disabled until a busy indicator falling edge is registered (see the [SPI Peripheral Synchronization in Conversion Mode](#) section).

The BSY_ALT_GP0 and GP3 pins can also be configured to perform other functions than the busy indicator, and all other higher priority functions must be disabled to configure these pins as the busy indicator. See the [General-Purpose Pins](#) section for details on configuring the general-purpose pins.

CHANNEL SEQUENCING MODES

In conversion mode, the AD4695/AD4696 multiplexer channel updates once per conversion period at the start of the ADC core acquisition phase, as described in the [Converter Operation](#) section. The multiplexer is controlled by internal channel sequencing logic, and there are four options for programming the channel sequence.

The standard sequencer and advanced sequencer automates progression through a preprogrammed channel sequence. When either the standard sequencer or advanced sequencer is enabled, the digital host is not required to provide channel sequencing instructions while reading conversion results over the SPI, which reduces the digital resource requirements.

Two-cycle command mode and single-cycle command mode allow the digital host to directly control the channel sequence via 5-bit commands written over the serial interface during conversion data readback frames. Two-cycle command mode and single-cycle command mode enable systems with dynamic and adaptive channel sequencing requirements, such as control loop applications.

[Figure 76](#) through [Figure 80](#) show conversion mode example timing diagrams of the AD4695/AD4696 multiplexer channel selection, ADC sampling, and conversion data output relative to the channel sequencing settings and the CNV signal. The BUSY signal refers to the busy indicator, which can be enabled on the BSY_ALT_GP0 pin, the GP3 pin, or the serial data outputs, as described in the [Busy Indicator](#) section. The SDOx signal refers to the SDO pin plus the addition serial data output signals if dual-SDO mode or quad-SDO mode is enabled, as described in the [Serial Data Output Modes](#) section.

[Table 15](#) shows the configuration settings used to select from the four channel sequencing modes. Both the STD_SEQ_EN bit and the NUM_SLOTS_AS bit field are located in the SEQ_CTRL register. The $\overline{CYC_CTRL}$ bit is located in the setup register.

As noted in the [Channel Configuration Options](#) section, when even and odd numbered inputs are paired, selecting the odd numbered

THEORY OF OPERATION

input using any of the four channel sequencing modes results in the same behavior as if the even numbered input were selected instead. For this reason, it is recommended to only include the even numbered input in the channel sequence.

Table 15. Register Settings for Channel Sequencing Modes

Channel Sequencing Mode	STD_SEQ_EN	NUM_SLOTS_AS	CYC_CTRL
Two-Cycle Command Mode	0	0x00	0
Single-Cycle Command Mode	0	0x00	1
Standard Sequencer	1	Don't care	0
Advanced Sequencer	0	0x01 to 0x7F	0

Standard Sequencer

The standard sequencer automates progression through a preprogrammed set of enabled channels. The standard sequencer is the simplest of the four channel sequencing modes and is ideal for systems with fixed, static channel sequences.

The standard sequencer advances through each enabled channel in ascending order and repeats the sequence until the device exits conversion mode. The multiplexer channel is updated to the next enabled channel each time a conversion result is ready. [Figure 76](#) shows an example where the standard sequencer, three analog inputs (IN0, IN2, and IN15), and the temperature sensor are enabled in the sequence with no oversampling on any channel.

The bits in the STD_SEQ_CONFIG register control which channels are included in the channel sequence when the standard sequencer is enabled. Each bit in the STD_SEQ_CONFIG register corresponds to one of the 16 analog inputs, and each channel is enabled if its corresponding bit is set to 1. If the TEMP_EN bit in the TEMP_CTRL register is set to 1, the temperature sensor is added to the end of the sequence as well. For the example in [Figure 76](#), the value programmed into the STD_SEQ_CONFIG register is 0x1005, and the TEMP_EN bit is set to 1.

To enable the standard sequencer, set the STD_SEQ_EN bit in the SEQ_CTRL register to 1 and set the CYC_CTRL bit in the setup register to 0 (see [Table 15](#)). The standard sequencer is enabled by default.

While the AD4695/AD4696 are in register configuration mode when the STD_SEQ_EN bit in the SEQ_CTRL register is set to 1, the multiplexer automatically connects the first enabled channel in the sequence to the ADC core inputs, which allows the ADC to acquire the signal on that channel even before the device enters conversion mode.

When the standard sequencer is enabled, the control bits in the CONFIG_IN0 register determine the configuration settings for all IN0 to IN15 analog inputs (except for the polarity mode, which is set for each INn analog input independently with the IN_MODE bit in the corresponding CONFIG_INn register). Therefore, all analog

inputs have the same pin pairing options, analog input high-Z mode enable settings, OSR settings, and threshold detection enable settings.

The multiplexer does not advance to the next channel in the sequence until the required number of conversions dictated by the selected channel OSR setting is complete. For example, if the OSR is set to 16, 16 CNV rising edges are required before the conversion result is ready and the multiplexer selects the next channel in the sequence. [Figure 77](#) shows an example timing diagram where the OSR for all channels is set to N. See the [Oversampling and Decimation](#) section for more information.

When the standard sequencer is enabled, each enabled analog input is sampled once per sequence iteration, which means each analog input has the same effective sample rate. See the [Effective Channel Sample Rate](#) section for more information.

Advanced Sequencer

The advanced sequencer automates progression through a preprogrammed channel sequence where the order of channels is completely customizable. The advanced sequencer enables highly flexible sequences of channels with minimal digital overhead.

The advanced sequencer steps through a set of channel slots, where each slot can be assigned to any of the 16 analog inputs and sequences can be between two and 128 slots. The sequence progresses through the enabled slots in ascending order starting from Slot 0, and the sequence is repeated until the device exits conversion mode. [Figure 77](#) shows an example where the advanced sequencer is enabled with four slots enabled and assigned to IN6, IN10, IN6, and IN3 with the temperature sensor enabled (with no oversampling on any channel).

The number of slots in the sequence is set with the NUM_SLOTS_AS bit field in the SEQ_CTRL register. Each slot channel assignment is set with the SLOT_INX bit fields in the AS_SLOTn registers (located at Register Address 0x0100 to Register Address 0x017F), where AS_SLOT0 corresponds to Slot 0, AS_SLOT1 corresponds to Slot 1 and so on. [Table 63](#) shows the values of SLOT_INX for each of the 16 analog inputs.

If the TEMP_EN bit in the TEMP_CTRL register is set to 1, the temperature sensor is appended to the end of the sequence. The temperature sensor cannot be selected with the SLOT_INX fields in the AS_SLOTn registers.

To enable the advanced sequencer, set the STD_SEQ_EN bit to 0, set the CYC_CTRL bit to 0, and set the NUM_SLOTS_AS field to any value between 1 and 127 (see [Table 15](#)).

While the AD4695/AD4696 are in register configuration mode when the STD_SEQ_EN bit in the SEQ_CTRL register is set to 0, the multiplexer automatically connects the channel specified in the AS_SLOT0 register to the ADC core inputs, which allows the ADC to acquire the signal on that channel even before the device enters conversion mode.

THEORY OF OPERATION

When the advanced sequencer is enabled, the configuration settings for each channel are set with the corresponding CONFIG_INn register. Therefore, all analog inputs can have different channel configuration options, analog input high-Z mode enable settings, OSR settings, and threshold detection enable settings. Configure each CONFIG_INn register before entering conversion mode and initiating conversions.

The multiplexer does not advance to the next channel in the sequence until the required number of conversions dictated by the selected channel OSR setting is complete. When the OSR of a channel in the sequence is set to a value other than 1 (when the OSR_SET bit field in the corresponding CONFIG_INn register is not set to 0x0), the advanced sequencer does not advance to the next channel in the sequence and the busy indicator does not transition low until the required number of conversions is complete. For example, if the OSR is set to 16, 16 CNV rising edges are required before the conversion result is ready and the multiplexer selects the next channel in the sequence. [Figure 78](#) shows an example timing diagram where OSR for IN0 is set to N. See the [Oversampling and Decimation](#) section for more information.

When the advanced sequencer is enabled, the channel sequence can be configured to achieve different effective sample rates for each channel. See the [Effective Channel Sample Rate](#) section for more information.

Two-Cycle Command Mode

Two-cycle command mode allows the digital host system to manually control the next channel in the sequence on-the-fly and enables dynamic channel sequencing without interrupting conversions.

In two-cycle command mode, the channel sequence is determined by 5-bit commands transmitted from the digital host during conversion result readback frames. The 5-bit commands are clocked in on SDI on the first five SCK rising edges in the frame and latched into memory on the sixth SCK falling edge in the frame. If a valid channel command is received, the conversion result for that channel is available after two conversion periods. [Figure 79](#) shows the relative timing between the 5-bit commands (represented by CMD) and the corresponding acquisition phase, conversion phase, and conversion result readback in two-cycle command mode.

Two-cycle command mode maximizes the acquisition time for all channels because the 5-bit channel commands are latched in before the multiplexer switches select the corresponding channel and begin the ADC acquisition phase.

[Table 18](#) shows the valid commands for selecting IN0 to IN15 or the temperature sensor. Commands other than those listed in [Table 18](#) are treated as no operation (NOOP) commands and result in the multiplexer repeating the previous channel.

When two-cycle command mode is enabled, the first analog input channel selected is the one specified in the AS_SLOT0 register. The channel only updates when a valid command code is received.

To enable two-cycle command mode, set the STD_SEQ_EN bit to 0, set the NUM_SLOTS_AS bit field to 0x00 and set the CYC_CTRL bit to 0 (see [Table 15](#)).

While the AD4695/AD4696 are in register configuration mode when the STD_SEQ_EN bit in the SEQ_CTRL register is set to 0, the multiplexer automatically connects the channel specified in the AS_SLOT0 register to the ADC core inputs, which allows the ADC to acquire the signal on that channel even before the device enters conversion mode.

When two-cycle command mode is enabled, the configuration settings for each channel are set with the corresponding CONFIG_INn register. Therefore, all analog inputs can have different channel configuration options, analog input high-Z mode enable settings, and threshold detection enable settings. Configure each CONFIG_INn register before entering conversion mode and initiating conversions.

Oversampling is not supported when two-cycle command mode is enabled. Set the OSR for all analog inputs to 1 before entering conversion mode with two-cycle command mode enabled (see the [Oversampling and Decimation](#) section).

Single-Cycle Command Mode

Single-cycle command mode allows the digital host system to manually control the next channel in the sequence on-the-fly and enables dynamic channel sequencing without interrupting conversions.

In single-cycle command mode, the channel sequence is determined by 5-bit commands transmitted from the digital host during conversion result readback frames. The 5-bit commands are clocked in on SDI on the first five SCK rising edges in the frame and latched into memory on the sixth SCK falling edge in the frame.

If a valid channel command is received, the conversion result for that channel is available in only one conversion period. [Figure 80](#) shows the relative timing between the 5-bit commands (represented by CMD) and the corresponding acquisition phase, conversion phase, and conversion result readback in single-cycle command mode.

Single-cycle command mode minimizes the latency between the 5-bit channel commands and the corresponding ADC data because the multiplexer switches select the specified channel immediately after the 5-bit command latches into memory. As a result, the acquisition time depends on how quickly the digital host can complete the write of the 5-bit command. [Figure 100](#) shows a conversion mode timing diagram with single-cycle command mode enabled, and [Table 2](#) lists the relevant timing specifications. The t_{ACQ} in single-cycle command mode is a function of t_{CYC} and the SCK period (t_{SCK}), and is calculated with the following expression:

$$t_{ACQ} = t_{CYC} - (5.5 \times t_{SCK}) \quad (7)$$

THEORY OF OPERATION

Table 18 shows the valid commands for selecting IN0 to IN15 or the temperature sensor. Commands other than those listed in Table 18 are treated as NOOP commands and result in the multiplexer repeating the previous channel.

When single-cycle command mode is enabled, the first analog input channel selected is the one specified in the AS_SLOT0 register. The channel only updates after a valid command is received.

To enable single-cycle command mode, set the STD_SEQ_EN bit to 0, set the NUM_SLOTS_AS bit field to 0x00, and set the CYC_CTRL bit to 1 (see Table 15).

When single-cycle command mode is enabled, the configuration settings for each channel are set with the corresponding CONFIG_INn register. Therefore, all analog inputs can have different channel configuration options, analog input high-Z mode enable settings, and threshold detection enable settings. Configure each CONFIG_INn register before entering conversion mode and initiating conversions.

Oversampling is not supported when single-cycle command mode is enabled. Set the OSR for all analog inputs to 1 before entering conversion mode with single-cycle command mode enabled (see the Oversampling and Decimation section).

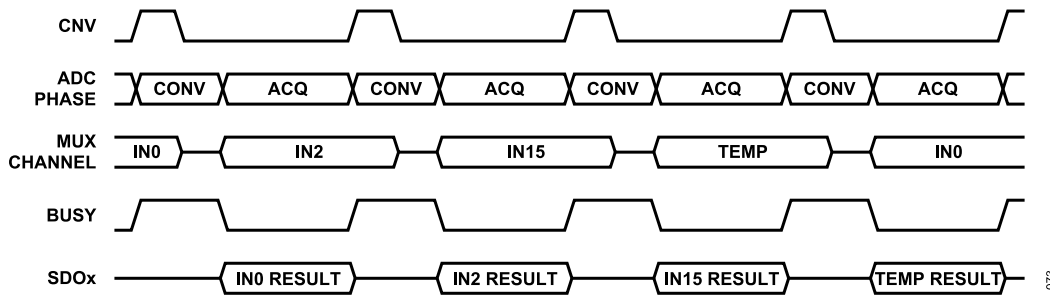

Figure 76. Standard Sequencer Example with OSR = 1

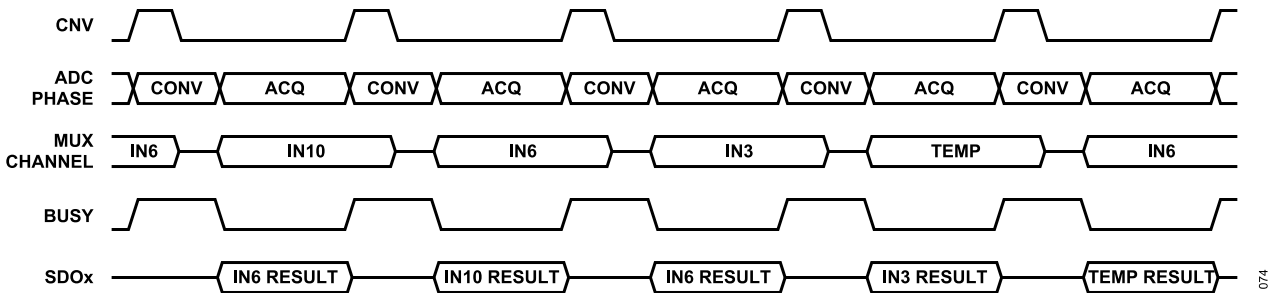

Figure 77. Advanced Sequencer Example with OSR = 1 for All Channels

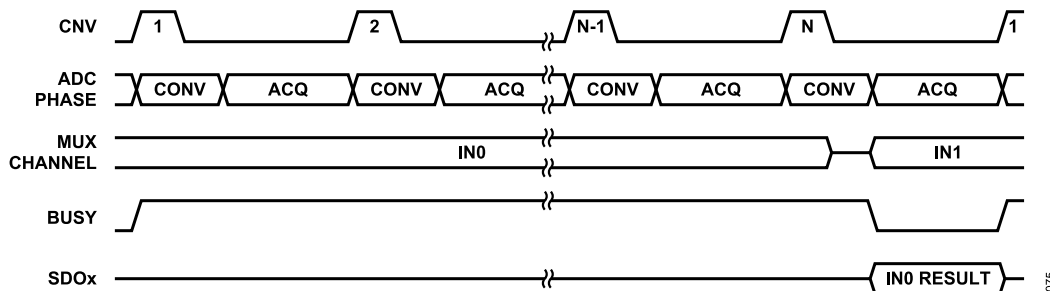

Figure 78. Standard Sequencer and Advanced Sequencer SPI Frames with IN0 OSR = N

THEORY OF OPERATION

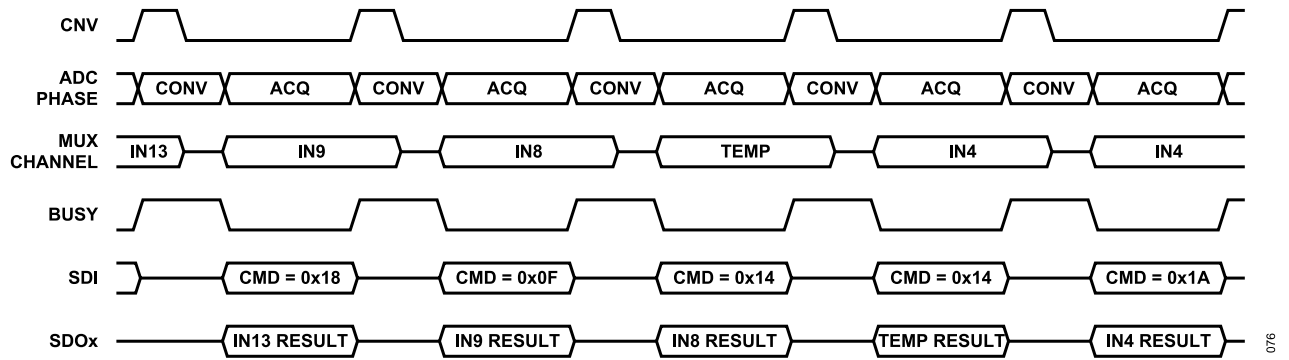

Figure 79. Two-Cycle Command Mode Timing

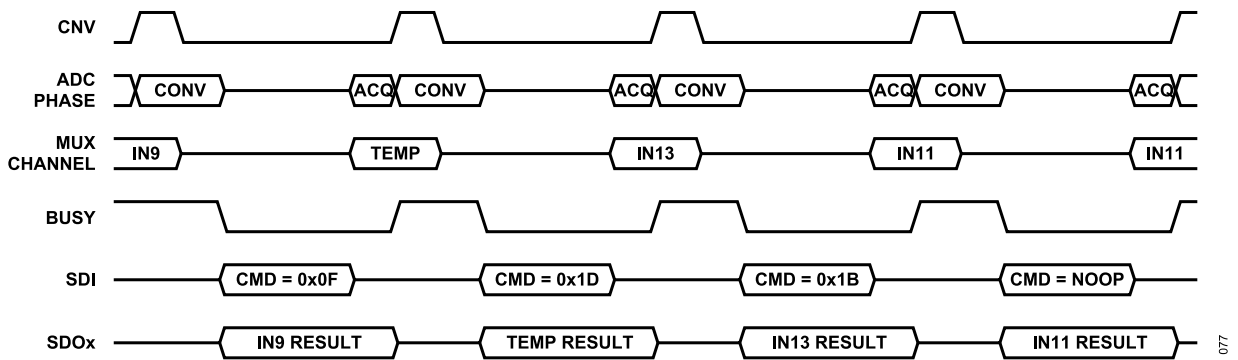

Figure 80. Single-Cycle Command Mode Timing

DIGITAL INTERFACE

The AD4695/AD4696 digital interface includes a 4-wire SPI, a convert start input (CNV), an active low reset input ($\overline{\text{RESET}}$), and a BSY_ALT_GP0 pin that functions as a general-purpose pin. The WLCSP option also includes three additional general-purpose pins (GP1, GP2, and GP3).

The AD4695/AD4696 digital interface has two operating modes, register configuration mode and conversion mode. In register configuration mode, the SPI is used to read from and write to the configuration registers. In conversion mode, the SPI is used to read conversion results and optional status bits. See the [Register Configuration Mode](#) section and [Conversion Mode](#) section more details on these operating modes.

The interface logic level is set by the VIO voltage, and supports 1.2 V to 1.8 V logic systems. The AD4695/AD4696 use SPI Mode 3 (clock phase (CPHA) = clock polarity (CPOL) = 1).

REGISTER CONFIGURATION MODE

When in register configuration mode, the digital host can read from and write to the AD4695/AD4696 configuration registers via the SPI. The device must be in register configuration mode to perform register read and write instructions. Register configuration mode is the default mode of operation on device power-up and reset.

The register configuration mode protocol is flexible and can be configured for efficient access of large blocks of the configuration register map. Each SPI frame consists of at least one instruction phase, at least one data phase, and an optional 8-bit cyclic redundancy check (CRC) checksum (see the [Checksum Protection](#) section). Data is transmitted over the SPI MSB first. The format and order of the instruction and data phases is configurable, as described in the [Instruction Phase](#) section through the [Checksum Protection](#) section. [Figure 81](#) shows an example of a basic SPI frame that consists of the instruction phase, data phase, and optional CRC checksum.

A $\overline{\text{CS}}$ falling edge starts an SPI frame and a subsequent $\overline{\text{CS}}$ rising edge ends the SPI frame. Data is latched on SDI on the SCK rising edges and shifted out on SDO on the SCK falling edges. For all SPI transactions, data is aligned MSB first.

[Figure 93](#) shows a detailed timing diagram for register read and write operations via the SPI when the device is in register configuration mode. See [Table 2](#) for the timing specifications shown in [Figure 93](#).

See the [Register Details](#) section for a detailed description of the addresses and functions of the AD4695/AD4696 configuration registers.

The 5-bit register configuration mode command switches the device from conversion mode into register configuration mode (see the [Register Configuration Mode Command](#) section).

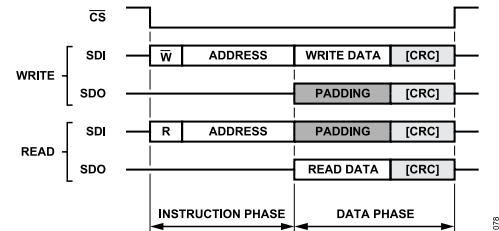

Figure 81. Basic SPI Frame

Instruction Phase

Each SPI frame starts with the instruction phase. The instruction phase immediately follows a $\overline{\text{CS}}$ falling edge (see [Figure 81](#)). The instruction phase consists of a read/write (R/W) bit followed by a register address word. Set the R/W bit high to initiate a read instruction or set the R/W bit low to initiate a write instruction. The register address word specifies the address of the register to be accessed. The register address word is 15 bits in length (long addressing) by default, and can be changed to 7 bits in length (short addressing) with the ADDR_LEN bit in the SPI_CONFIG_B register.

When using single instruction mode, each register read or write transaction in an SPI frame begins with an instruction phase. When using streaming mode, only one instruction phase is required per SPI frame to access a set of contiguous registers. See the [Single Instruction Mode](#) section and the [Streaming Mode](#) section for instructions on selecting and using these modes.

Data Phase

During the data phase, register data is either shifted out on SDO on SCK falling edges (for register reads) or latched in on SDI on SCK rising edges (for register writes). The data phase can include the data for an entire register or individual bytes of the register (see the [Multibyte Register Access](#) section).

If the CRC is disabled, the register contents are updated immediately after the final SCK rising edge of the data phase. If the CRC is enabled, the register contents are updated immediately after the final SCK rising edge of the checksum (if the checksum value matches the data in the data phase).

Address Direction Options

The address direction options control whether the address is set to automatically increment or decrement when accessing multiple bytes of data in a single data phase (for example, when accessing multibyte registers or when streaming mode is enabled). [Figure 82](#) and [Figure 83](#) show SPI frames with both address direction options.

Select between the two address direction options with the ADDR_DIR bit in the SPI_CONFIG_A register. When the ADDR_DIR bit is set to 0, the descending address option is selected and the address decrements after each byte is accessed. When the ADDR_DIR bit is set to 1, the ascending address option is

DIGITAL INTERFACE

selected and the address increments after each byte is accessed. The descending address option is selected by default.

Multibyte Register Access

Some AD4695/AD4696 configuration registers contain multiple bytes of data stored in adjacent address locations in memory. These registers are referred to as multibyte registers. The address of each multibyte register is defined as the address of its least significant byte (LSByte), but the multibyte register contents extend across multiple register addresses. For example, the STD_SEQ_CONFIG register (Address 0x0024) is two bytes long, the address of its LSByte is 0x0024, and the address of its MSByte is 0x0025. Table 31 specifies whether registers are single byte or multibyte.

The state of the MB_STRICT bit in the SPI_CONFIG_C register determines whether multibyte registers are treated as a single unit of memory with one register address or as multiple registers that are each one byte long with individual register addresses.

When the MB_STRICT bit is set to 0, each byte of a multibyte register must be read from or written to individually, which allows the digital host to access one byte of a multibyte register without accessing the other byte(s). With this setting, all data phases in an SPI frame consist of a single byte rather than the entire multibyte register, and each byte in a multibyte register is directly addressable. The contents of either byte are updated by an SPI write transaction as long as new data is provided for that entire byte. Figure 85 and Figure 90 show examples where individual bytes in a multibyte register (address = 0x0043) are accessed over multiple SPI transactions in streaming mode and single instruction mode with MB_STRICT = 0.

When the MB_STRICT bit is set to 1, all bytes of a multibyte register must be read from or written to in the same SPI transaction. With this setting, the data phase includes all bytes when accessing a multibyte register. If the digital host fails to read from or write to the entire multibyte register, the SPI transaction is considered invalid and the MB_ERROR flag in the SPI_STATUS register is set to 1. This setting ensures that all modes or enable bits associated with a multibyte register are updated simultaneously. The MB_STRICT bit is set to 1 by default.

When the MB_STRICT bit is set to 1, the order in which each byte of a multibyte register is read from or written to depends on the selected address direction option (see the Address Direction Options section). With the descending addresses option selected, the first byte accessed in the data phase is the MSByte of the multibyte register, and each subsequent byte corresponds to the data in the next lowest address. With the ascending addresses option selected, the first byte accessed in the data phase is the LSByte of the multibyte register and each subsequent byte corresponds to the data in the next highest address. Figure 82 and Figure 83 show generalized read and write transactions of a multibyte register for both address direction options.

When CRC is enabled, a checksum follows the data phase for each SPI transaction. When the MB_STRICT bit is set to 0, the checksum occurs after each byte of a multibyte register is accessed (see Figure 85 and Figure 90). When the MB_STRICT bit is set to 1, the checksum only occurs after all bytes of the multibyte register are accessed (see Figure 86 and Figure 91).

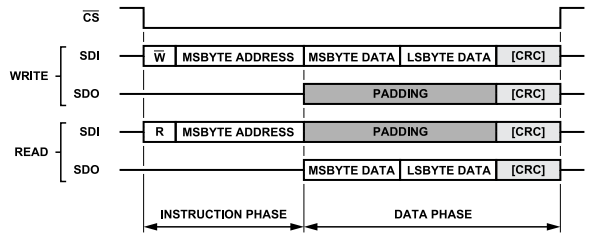

Figure 82. Multibyte Register Access with MB_STRICT = 1 and Descending Address

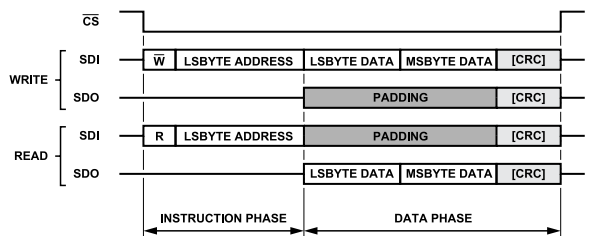

Figure 83. Multibyte Register Access with MB_STRICT = 1 and Ascending Address

DIGITAL INTERFACE

Streaming Mode

When the INST_MODE bit in the SPI_CONFIG_B register is set to 0, streaming mode is enabled. In streaming mode, only one instruction phase is required per SPI frame and the register address being read from or written to is automatically updated after each data phase (based on the selected address direction option). The instruction phase is followed by multiple data phases for each register being accessed until the end of the SPI frame. Streaming mode enables efficient access to large, contiguous sections of the configuration register map, such as when updating the advanced sequencer slot registers (AS_SLOTn) to configure the advanced sequencer.

Figure 84 shows a generalized SPI frame for performing multiple register read and write transactions with streaming mode selected. Because there is only one instruction phase per frame in streaming mode, all SPI transactions in a given SPI frame are either all reads or all writes. The checksum is included in each data phase only if CRC is enabled (see the Checksum Protection section).

Figure 85 to Figure 87 show examples of accessing different parts of the register map with both address direction options and with both MB_STRICT options (see the Multibyte Register Access section).

When streaming mode is active, a specified number of registers can be looped to repeatedly access the same registers multiple times in a single SPI frame. The LOOP_COUNT bit field in the LOOP_MODE register determines how many registers are accessed before the register address is reset to the starting address (the one specified in the instruction phase). When the MB_STRICT bit is set to 1, a multibyte register is considered one register when looping. When the MB_STRICT bit is set to 0, each byte of a multibyte register is considered one register when looping. Figure 88 shows an example using looping to repeatedly read from the CLAMP_STATUSn registers.

If the LOOP_COUNT bit field is set to 0x0, looping is disabled. If looping is disabled and the descending address option is selected, the address decrements until it reaches Address 0x0000,

and the address is set to the highest valued register address available (Address 0x013F) on the subsequent byte access. If looping is disabled and the ascending address option is selected, the address increments until it reaches the highest valued register address available (Address 0x013F), and the address is set to Address 0x0000 on the subsequent byte access. Looping is disabled by default.

Note that even when using 7-bit addressing, registers with addresses larger than 0xFF are still accessible in streaming mode. However, accessing these registers is generally more efficient using 15-bit addressing.

Single Instruction Mode

When the INST_MODE bit in the SPI_CONFIG_B register is set to 1, single instruction mode is enabled. In single instruction mode, each SPI read or write transaction includes an instruction phase to specify whether the transaction is a read or a write and what address is being accessed. Single instruction mode allows the digital host to quickly read from or write to registers with nonadjacent register addresses in a single SPI frame, as opposed to streaming mode, which allows exclusively reading from or writing to registers with adjacent addresses without starting a new SPI frame.

Figure 89 shows a generalized SPI frame for performing multiple register read and write transactions with single instruction mode selected. The checksum is included in each data phase only if CRC is enabled (see the Checksum Protection section).

Figure 90 shows an example of reading from and writing to the most significant byte and least significant byte of the UPPER_IN1 register (MB_STRICT = 0). Figure 91 and Figure 92 show examples of reading from the UPPER_IN1 register and writing to the UPPER_IN0 register in the same frame with both address direction options (MB_STRICT = 1). Note that the UPPER_INn registers are multibyte registers, and when MB_STRICT is set to 1, both bytes must be read from or written to in one data phase (see the Multibyte Register Access register section).

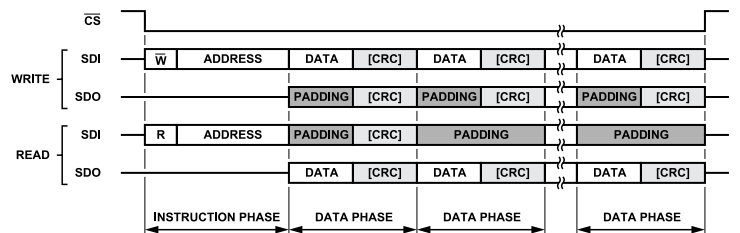

Figure 84. Streaming Mode SPI Frame

DIGITAL INTERFACE

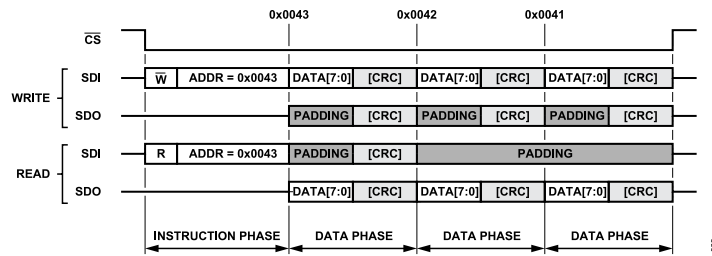

Figure 85. Streaming Mode SPI Frame, Looping Disabled, Descending Address, MB_STRICT = 0

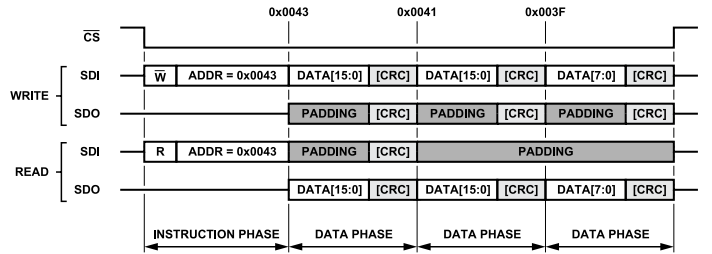

Figure 86. Streaming Mode SPI Frame, Looping Disabled, Descending Address, MB_STRICT = 1

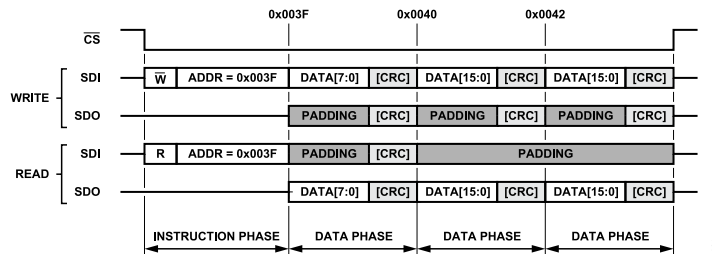

Figure 87. Streaming Mode SPI Frame, Looping Disabled, Ascending Address, MB_STRICT = 1

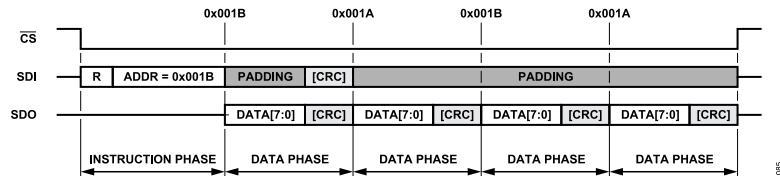

Figure 88. Streaming Mode SPI Frame, Looping Enabled, LOOP_COUNT = 7, Descending Address

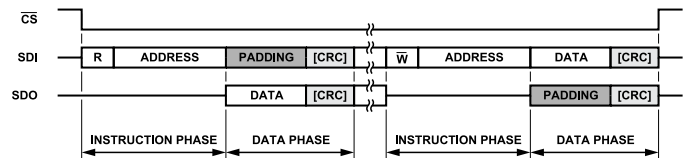

Figure 89. Single Instruction Mode SPI Frame

DIGITAL INTERFACE

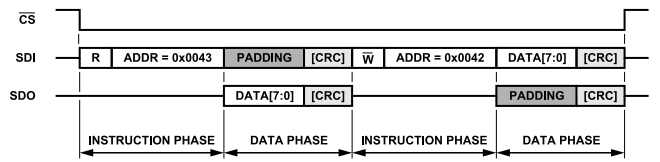

Figure 90. Single Instruction Mode SPI Frame, $MB_STRICT = 0$

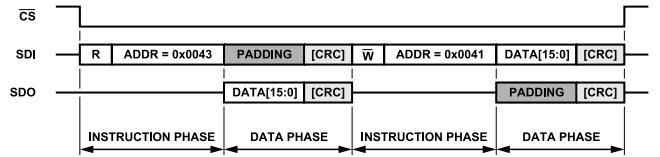

Figure 91. Single Instruction Mode SPI Frame, $MB_STRICT = 1$, Descending Address

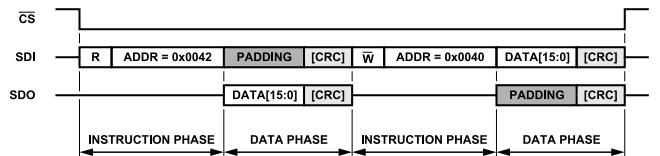

Figure 92. Single Instruction Mode SPI Frame, $MB_STRICT = 1$, Ascending Address

Checksum Protection

The AD4695/AD4696 include optional error checking based on an 8-bit CRC in register configuration mode. When the CRC is enabled, an 8-bit checksum code is appended to the data phase of each register read or write transaction. The value of the checksum is calculated from the data read or written over the SPI, and therefore allows the AD4695/AD4696 and the digital host to detect corrupted data. If the checksum does not match the corresponding register data, the register read or write is considered invalid.

Figure 84 shows a generalized SPI frame for performing register reads and writes with streaming mode selected, including the CRC checksum. Figure 89 shows a generalized SPI frame for performing register reads and writes with single instruction mode selected, including the CRC checksum. Note that the checksums on SDI shown in both Figure 84 and Figure 89 are sent from the digital host to the AD4695/AD4696, and the digital host must send a valid checksum during the SPI read and write transactions pictured. The only exception is when performing multiple register reads with streaming mode selected, where the digital host is only required to send a CRC on SDI for the first transaction (see Figure 84).

When the AD4695/AD4696 receive a checksum that does not match its corresponding SPI transaction, the transaction is considered invalid, and the CRC_ERROR bit in the SPI_STATUS register is set to 1. The CRC_ERROR bit is a write 1 to clear bit (R/W1C) and must be written to 1 to be cleared.

When a write transaction is considered invalid, register contents are not updated. When a read transaction is considered invalid, the digital host must ignore the received register data and attempt the register read transaction again. Read to clear bits are only cleared

when the register read transaction is considered valid (for example, the HI_INn and LO_INn bits in the $ALERT_STATUSn$ registers).

When streaming mode and the CRC are both enabled and an invalid checksum is received for a given SPI transaction, all subsequent SPI transactions are considered invalid for the remainder of the SPI frame (until \overline{CS} is brought high).

The CRC is enabled with the CRC_EN and CRC_EN_N bit fields in the SPI_CONFIG_C register. To enable the CRC, CRC_EN must be set to 0x1 and CRC_EN_N must be set to 0x2. CRC is disabled for all other combinations of CRC_EN and CRC_EN_N .

The AD4695/AD4696 expect checksums to be included in each SPI transaction immediately after the CRC is enabled. Write to the SPI_CONFIG_C register to enable the CRC before writing to any other registers, then read the SPI_CONFIG_C register assuming that the CRC has been enabled. If the host receives the correct state of the CRC_EN and CRC_EN_N bit fields and a valid checksum, the CRC is enabled, and the host can begin configuring the remaining configuration registers.

The following CRC polynomial is used to calculate the checksum from the data:

$$x^8 + x^2 + x + 1 \quad (8)$$

The CRC calculation is seeded by a non-zero value to detect if the data lines are stuck low. Table 16 shows the data and seed values for each possible type of SPI transaction.

In single instruction mode, the seed for all CRCs is 0xA5. In streaming mode, the seed for the first CRC in the frame is also 0xA5, but the seed for the remaining CRCs in the frame is the LSB byte

DIGITAL INTERFACE

of the register address being accessed. If MB_STRICT is set to 1 and a multibyte register is accessed, the register address used for the seed depends on the selected address direction option. The address of the MSByte is used with descending address, and the address of the LSByte is used with ascending address. For

example, in both [Figure 86](#) and [Figure 87](#), the second data phase includes data from the UPPER_IN0 register, but the seed used for the checksum is 0x41 with the descending address option ([Figure 86](#)) and 0x40 with the ascending address option ([Figure 87](#)).

Table 16. CRC Input Values for SPI Modes and Transactions

SPI Transaction Type	Pin	Single Instruction Mode or First CRC with Streaming Mode	Subsequent CRCs with Streaming Mode
Write	SDI	SPI data = instruction phase bits, data phase bits Seed = 0xA5	SPI data = data phase bits Seed = LSByte of current register address
	SDO	SPI data = instruction phase bits, data phase bits Seed = 0xA5	SPI data = data phase bits Seed = LSByte of current register address
Read	SDI	SPI data = instruction phase bits, padding bits Seed = 0xA5	Not applicable
	SDO	SPI data = instruction phase bits, data phase bits Seed = 0xA5	SPI data = data phase bits Seed = LSByte of current register address

DIGITAL INTERFACE

Register Read and Write Timing Diagrams

Figure 93 shows a timing diagram for the SPI when the AD4695/AD4696 are in register configuration mode. See Table 2 for the timing specifications pictured in Figure 93.

Register read and write transactions are framed by \overline{CS} . While \overline{CS} is high, SCK edges are ignored, and SDO is high impedance. A falling edge on \overline{CS} begins an SPI frame and data on SDI is latched on SCK rising edges while data is shifted out on SDO on SCK falling edges. A rising edge on \overline{CS} ends the SPI frame and forces SDO to high impedance.

The first phase of an SPI frame immediately following a \overline{CS} falling edge is the instruction phase. The instruction phase is followed by the data phase. For SPI read transactions, the register contents are shifted out on SDO during the data phase. For SPI write transactions, the register contents are latched in on SDI during the data phase. See the Streaming Mode and Single Instruction Mode sections for a detailed description of the order of instruction and data phases in each SPI frame.

The length of the address in the instruction phase (represented by M in Figure 93) is set by the ADDR_LEN bit in the SPI_CONFIG_B register (see the Instruction Phase section).

The length of the data phase (represented by N in Figure 93) depends on whether the CRC is enabled and the length of the register being accessed (see the Checksum Protection and Multibyte Register Access sections).

The AD4695/AD4696 ignore the state of CNV when in register configuration mode. The Entering Conversion Mode section describes the process for placing the AD4695/AD4696 in conversion mode.

Entering Conversion Mode

To place the AD4695/AD4696 in conversion mode, set the SPI_MODE bit in the setup register to 1. When the SPI_MODE bit is set to 1, the SPI frame immediately terminates, and the device enters conversion mode. No further register reads or writes can occur until the device enters register configuration mode again.

The digital host must provide a delay specified by t_{SCKCNV} after the final SCK rising edge of the register write before initiating conversions with a CNV rising edge (see Table 2 and Figure 93).

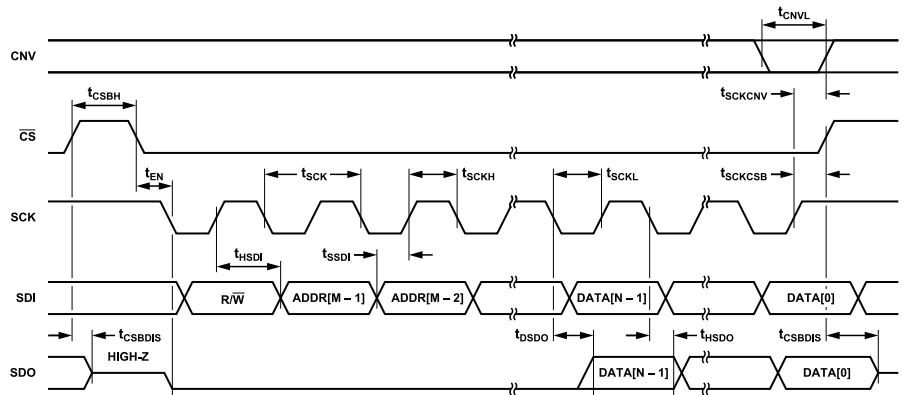

Figure 93. Register Configuration Mode Timing Diagram

DIGITAL INTERFACE

CONVERSION MODE

When the AD4695/AD4696 are in conversion mode, CNV rising edges initiate conversions on the selected channel and the channel sequencing logic updates the multiplexer to the next channel (see the [Converter Operation](#) and [Channel Sequencing Modes](#) sections). The device enters conversion mode when the SPI_MODE bit in the setup register is set to 1.

In conversion mode, the SPI is used to read the ADC results and write the 5-bit SDI commands shown in [Table 18](#). [Figure 94](#) to [Figure 101](#) show timing diagrams for SPI frames relative to performing conversions. The CNV pin and \overline{CS} pin can be tied together to enable interfacing with a single 4-wire SPI port (see [Figure 101](#)). Each ADC result is available until the next CNV rising edge occurs.

An optional set of five status bits can be appended to the ADC data. The status bits include channel information, the overvoltage clamp flag, and a threshold detection alert indicator. See the [Status Bits](#) section for a description of the status bits and how they are enabled.

In conversion mode, the general purpose pins can be assigned as an additional serial data output to reduce the SCK frequency required to shift out the ADC result plus optional status bits before the next conversion occurs. See the [Serial Data Output Modes](#) section for a description of the options available on both package options of the AD4695/AD4696 and how to enable these modes.

The general purpose pins can also be assigned as either the busy indicator or the threshold detection alert indicator. [Figure 94](#) to [Figure 101](#) show the relative timing of the CNV signal and the busy and alert indicators when they are assigned to the general purpose pins. The [General-Purpose Pins](#) section describes how to set the general purpose pins to the desired function.

Table 17. Status Bits Names and Descriptions

Status Word Index	Bit Name	Description
Bit 4	OV_ALT	Active high. Indicates the status of the overvoltage protection clamp flag and (if enabled) the status of the threshold detection alert indicator.
Bits[3:0]	INX	Indicates what analog input channel the ADC data corresponds to (IN0 to IN15).

Table 18. Conversion Mode Commands

Channel Sequencing Mode	5-Bit SDI Command (CMD)	Description
Two-Cycle Command Mode and Single-Cycle Command Mode	0x00 to 0x09, 0x0B to 0x0E	NOOP
	0x0A	Register configuration mode command
	0x0F	Temperature sensor channel selection
	0x10 to 0x1F	IN0 to IN15 channel selection
Standard Sequencer and Advanced Sequencer	0x00 to 0x09, 0x0B to 0x1F	NOOP
	0x0A	Register configuration mode command

When autcycle mode is enabled, the AD4695/AD4696 generate their own internal convert start signal to autonomously perform conversions without a CNV signal from the digital host (see the [Autocycle Mode](#) section).

Status Bits

A set of five status bits can be appended to the end of each conversion result. The status bits allow the digital host to monitor the status of the analog inputs without interrupting analog-to-digital conversions. [Table 17](#) shows the names and descriptions of the status bits.

By default, the OV_ALT status bit indicates the status of the overvoltage clamp flags (the bitwise logical OR of the CLAMP_FLAG bit and COM_CLAMP_FLAG bit in the status register). When the OV_ALT_MODE bit in the GP_MODE register is set to 1, the OV_ALT status bit is the logical OR of the CLAMP_FLAG bit and the threshold detection alert indicator (TD_ALERT bit in the status register). The digital host can monitor the state of the OV_ALT bit to detect and respond to out of range events.

The INX bits indicate which of the 16 analog inputs the conversion result corresponds to. The values for the INX bits range from 0 to 15 (0x0 to 0xF) and correspond to IN0 to IN15, respectively. An INX value of 15 corresponds to either IN15 or the temperature sensor. The INX bits can be used by the digital host to align the ADC data with the sequence of analog input channels.

Set the STATUS_EN bit in the setup register to 1 to enable the status bits. The status bits are disabled by default. When the status bits are enabled, the serial data output word extends to 24 bits, where Bit 20 to Bit 24 contain the status bits (see [Table 21](#), [Table 22](#) and [Table 23](#)).

DIGITAL INTERFACE

Serial Data Output Modes

The AD4695/AD4696 digital interface allows clocking out ADC data on more than one serial data output, which reduces the number of SCK periods required to access the full ADC result and allows slower SCK frequencies. The three serial data output modes include single-SDO mode, dual-SDO mode, and quad-SDO mode. In single-SDO mode, the ADC results are only shifted out on SDO. In dual-SDO mode and quad-SDO mode, ADC results are shifted out on SDO and general-purpose pins in parallel.

Table 19 shows the pins used for each serial data output signal for each serial data output mode. Table 21 and Table 22, show the formatting of conversion results for all combinations of serial data output modes, status bits, and OSR options. The values of the blank cells in Table 21 and Table 22 depend on the setting of SDO_STATE, as described in the Conversion Mode Timing Diagrams section.

The serial data output modes only apply when the device is in conversion mode. In register configuration mode, register read data is always shifted out serially on SDO only.

The SDO_MODE bit field in the setup register determines which serial data output mode is selected. Table 20 shows the values

of SDO_MODE and the corresponding serial data output modes. Quad-SDO mode is only available in the WLCSP option of the AD4695/AD4696.

Table 19. Serial Data Output Mode Pin Assignments

Mode	Signal	LFCSP Pins	WLCSP Pins
Single-SDO Mode	SDO0	SDO	SDO
Dual-SDO Mode	SDO1	BSY_ALT_GP0	GP1
	SDO0	SDO	SDO
Quad-SDO Mode	SDO3	N/A	GP3
	SDO2	N/A	GP2
	SDO1	N/A	GP1
	SDO0	N/A	SDO

Table 20. SDO_MODE Values vs. Serial Data Output Mode

SDO_MODE	Mode (LFCSP)	Mode (WLCSP)
0x0	Single-SDO Mode	Single-SDO Mode
0x1	Dual-SDO Mode	Dual-SDO Mode
0x2	Single-SDO Mode	Quad-SDO Mode
0x3	Single-SDO Mode	Single-SDO Mode

Table 21. Single-SDO Mode Data Output Format

OSR Setting	Status Bits	Signal	SCK Falling Edge Number															
			1	2	3	...	15	16	17	18	19	20	21	22	23	24		
1	Disabled	SDO0	D15	D14	D13	...	D1	D0										
4	Disabled	SDO0	D16	D15	D14	...	D2	D1	D0									
16	Disabled	SDO0	D17	D16	D15	...	D3	D2	D1	D0								
64	Disabled	SDO0	D18	D17	D16	...	D4	D3	D2	D1	D0							
1	Enabled	SDO0	D15	D14	D15	...	D1	D0	0	0	0	OV_ALT	INX[3]	INX[2]	INX[1]	INX[0]		
4	Enabled	SDO0	D16	D15	D16	...	D2	D1	D0	0	0	OV_ALT	INX[3]	INX[2]	INX[1]	INX[0]		
16	Enabled	SDO0	D17	D16	D17	...	D3	D2	D1	D0	0	OV_ALT	INX[3]	INX[2]	INX[1]	INX[0]		
64	Enabled	SDO0	D18	D17	D16	...	D4	D3	D2	D1	D0	OV_ALT	INX[3]	INX[2]	INX[1]	INX[0]		

Table 22. Dual-SDO Mode Data Output Format

OSR Setting	Status Bits	Signal	SCK Falling Edge Number												
			1	2	3	4	5	6	7	8	9	10	11	12	
1	Disabled	SDO1	D15	D13	D11	D9	D7	D5	D3	D1					
		SDO0	D14	D12	D10	D8	D6	D4	D2	D0					
4	Disabled	SDO1	D16	D14	D12	D10	D8	D6	D4	D2	D0				
		SDO0	D15	D13	D11	D9	D7	D5	D3	D1					
16	Disabled	SDO1	D17	D15	D13	D11	D9	D7	D5	D3	D1				
		SDO0	D16	D14	D12	D10	D8	D6	D4	D2	D0				
64	Disabled	SDO1	D18	D16	D14	D12	D10	D8	D6	D4	D2	D0			
		SDO0	D17	D15	D13	D11	D9	D7	D5	D3	D1				
1	Enabled	SDO1	D15	D13	D11	D9	D7	D5	D3	D1	0	0		INX[3]	INX[2]
		SDO0	D14	D12	D10	D8	D6	D4	D2	D0	0	OV_ALT		INX[1]	INX[0]
4	Enabled	SDO1	D16	D14	D12	D10	D8	D6	D4	D2	D0	0		INX[3]	INX[2]
		SDO0	D15	D13	D11	D9	D7	D5	D3	D1	0	OV_ALT		INX[1]	INX[0]
16	Enabled	SDO1	D17	D15	D13	D11	D9	D7	D5	D3	D1	0		INX[3]	INX[2]
		SDO0	D16	D14	D12	D10	D8	D6	D4	D2	D0	0		INX[1]	INX[0]

DIGITAL INTERFACE

Table 22. Dual-SDO Mode Data Output Format

OSR Setting	Status Bits	Signal	SCK Falling Edge Number											
			1	2	3	4	5	6	7	8	9	10	11	12
64	Enabled	SDO0	D16	D14	D12	D10	D8	D6	D4	D2	D0	OV_ALT	INX[1]	INX[0]
		SDO1	D18	D16	D14	D12	D10	D8	D6	D4	D2	D0	INX[3]	INX[2]
		SDO0	D17	D15	D13	D11	D9	D7	D5	D3	D1	OV_ALT	INX[1]	INX[0]

Table 23. Quad-SDO Mode Data Output Format

OSR Setting	Status Bits	Signal	SCK Falling Edge Number					
			1	2	3	4	5	6
1	Disabled	SDO3	D15	D11	D7	D3		
		SDO2	D14	D10	D6	D2		
		SDO1	D13	D9	D5	D1		
		SDO0	D12	D8	D4	D0		
4	Disabled	SDO3	D16	D12	D8	D4	D0	
		SDO2	D15	D11	D7	D3		
		SDO1	D14	D10	D6	D2		
		SDO0	D13	D9	D5	D1		
16	Disabled	SDO3	D17	D13	D9	D5	D1	
		SDO2	D16	D12	D8	D4	D0	
		SDO1	D15	D11	D7	D3		
		SDO0	D14	D10	D6	D2		
64	Disabled	SDO3	D18	D14	D10	D6	D2	
		SDO2	D17	D13	D9	D5	D1	
		SDO1	D16	D12	D8	D4	D0	
		SDO0	D15	D11	D7	D3		
1	Enabled	SDO3	D15	D11	D7	D3	0	INX[3]
		SDO2	D14	D10	D6	D2	0	INX[2]
		SDO1	D13	D9	D5	D1	0	INX[1]
		SDO0	D12	D8	D4	D0	OV_ALT	INX[0]
4	Enabled	SDO3	D16	D12	D8	D4	D0	INX[3]
		SDO2	D15	D11	D7	D3	0	INX[2]
		SDO1	D14	D10	D6	D2	0	INX[1]
		SDO0	D13	D9	D5	D1	OV_ALT	INX[0]
16	Enabled	SDO3	D17	D13	D9	D5	D1	INX[3]
		SDO2	D16	D12	D8	D4	D0	INX[2]
		SDO1	D15	D11	D7	D3	0	INX[1]
		SDO0	D14	D10	D6	D2	OV_ALT	INX[0]
64	Enabled	SDO3	D18	D14	D10	D6	D2	INX[3]
		SDO2	D17	D13	D9	D5	D1	INX[2]
		SDO1	D16	D12	D8	D4	D0	INX[1]
		SDO0	D15	D11	D7	D3	OV_ALT	INX[0]

Conversion Mode Timing Diagrams

Figure 94 to Figure 101 show detailed timing diagrams for performing analog-to-digital conversions when the AD4695/AD4696 are in conversion mode with each serial data output mode option (with autcycle mode disabled).

When the device is in conversion mode, a CNV rising edge initiates a conversion and enters the conversion phase (see the Converter

Operation section). When a conversion is initiated, it continues until completion regardless of the state of CNV. When the standard sequencer, advanced sequencer, or two-cycle command mode is enabled, the device enters the acquisition phase before the conversion phase is complete. When single-cycle command mode is enabled, the device enters the acquisition phase after the sixth SCK rising edge in the SPI frame. Figure 94 to Figure 99 and Figure 101 show t_{ACQ} when the standard sequencer, advanced sequencer, or

DIGITAL INTERFACE

two-cycle command mode is enabled. [Figure 100](#) shows t_{ACQ} when single-cycle command mode is enabled.

\overline{CS} frames the conversion result data. While \overline{CS} is high, SCK edges are ignored, and all pins assigned as serial data outputs are high impedance. While \overline{CS} is low, data is clocked out with the MSB first on the serial data output(s) on SCK falling edges, and data is latched in on SDI on the SCK rising edges.

CNV and \overline{CS} can be tied together and driven by the chip select of the host SPI to minimize the number of digital signals required to interface with the AD4695/AD4696 (see the [SPI Peripheral Connections](#) section). [Figure 101](#) shows a timing diagram of the AD4695/AD4696 interfacing with a 4-wire SPI with the CNV and \overline{CS} signals tied together.

The conversion phase must be complete before the digital host provides the first SCK falling edge. The digital host can use the busy indicator falling edge to detect the end of the conversion phase and to begin clocking out the ADC results. Otherwise, the digital host must include a delay dictated by the conversion time specification ($t_{CONVERT}$) in [Table 2](#) between the CNV rising edge and the first SCK falling edge.

The 5-bit SDI commands shown in [Table 18](#) are latched in on SDI on the first five SCK rising edges in the SPI frame. The register configuration mode command instructs the AD4695/AD4696 to exit conversion mode and enter register configuration mode (see the [Register Configuration Mode Command](#) section). The channel select commands in [Table 18](#) are only used when two-cycle command mode or single-cycle command mode is enabled. These commands are interpreted as NOOP commands when the standard sequencer or the advanced sequencer is enabled (see the [Channel Sequencing Modes](#) section).

To ensure optimal performance, there must be a sufficient delay between the final SCK edge and the next CNV rising edge, and there must be no SCK activity until the conversion time has elapsed (see t_{SCKCNV} in [Table 2](#) and [Figure 94](#) to [Figure 101](#)).

The SDO_STATE bit in the setup register determines the behavior of the serial data output(s) at the beginning and the end of the conversion mode SPI frames. When the SDO_STATE bit is set to 0, the serial data output(s) hold their final value(s) until the MSB of the next conversion result is clocked out. The serial data output(s) remain in this state even if multiple extra SCK falling edges occur after the full result is shifted out. The serial data output(s) are forced to high impedance when \overline{CS} is brought high, but return to the previous state after \overline{CS} is brought low again. [Figure 94](#), [Figure 96](#), and [Figure 98](#) show the behavior of the serial data output(s) when SDO_STATE is set to 0. SDO_STATE is set to 0 by default.

When SDO_STATE is set to 1, the busy indicator is enabled on the serial data output(s) (see the [Busy Indicator](#) section). The serial data output(s) are forced to high impedance if any SCK falling edges occur after the final bits of the result are already clocked out, or when CNV or \overline{CS} is brought high. When a CNV rising edge initiates a conversion, the serial data output(s) remain high impedance until the conversion phase is complete and the result is available to be read over the SPI. The serial data output(s) are driven low when the data is ready. If the current selected channel has an OSR greater than 1, the serial data output(s) are driven low after the oversampled result is ready. Note that \overline{CS} must be driven low for the busy indicator to appear on the serial data output(s).

When the busy indicator is enabled on a general-purpose pin, the selected general-purpose pin is driven high after a CNV rising edge and is driven low when the conversion is complete (see the [Busy Indicator on General-Purpose Pins](#) section). The BUSY signal in [Figure 94](#) to [Figure 100](#) represents the general-purpose pin assigned as the busy indicator. [Figure 78](#) in the [Channel Sequencing Modes](#) section shows the relative timing of the CNV rising edge and the busy indicator for OSR settings of 1 and greater than 1.

When the threshold detection alert indicator is enabled on a general-purpose pin, the selected general-purpose pin reflects the value of the TD_ALERT bit in the status register. The ALERT signal in [Figure 94](#) to [Figure 100](#) represents the general-purpose pin assigned as the alert indicator. [Figure 78](#) in the [Channel Sequencing Modes](#) section show the relative timing of the CNV rising edge and the alert indicator for OSR settings of 1 and greater than 1.

Register Configuration Mode Command

The register configuration mode command is a 5-bit command written on SDI that instructs the device to exit conversion mode and enter register configuration mode. The register configuration mode command is 0x0A. [Figure 102](#) shows the relative timing of the register configuration mode command and the AD4695/AD4696 entering register configuration mode.

The register configuration mode command is clocked in on SDI on the first five SCK rising edges after a conversion. When the register configuration mode command is received, the subsequent rising edge on \overline{CS} places the AD4695/AD4696 in register configuration mode. The digital host must wait for the $t_{REGCONFIG}$ delay (shown in [Figure 102](#) and [Table 2](#)) to elapse between the fifth SCK rising edge and the \overline{CS} rising edge.

DIGITAL INTERFACE

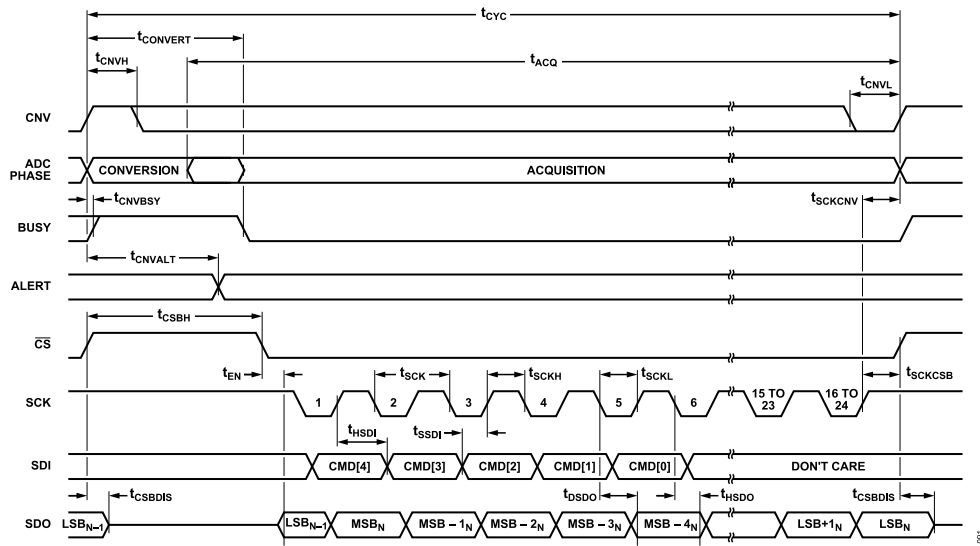

Figure 94. Conversion Mode Timing Diagram, Single-SDO Mode, SDO_STATE = 0

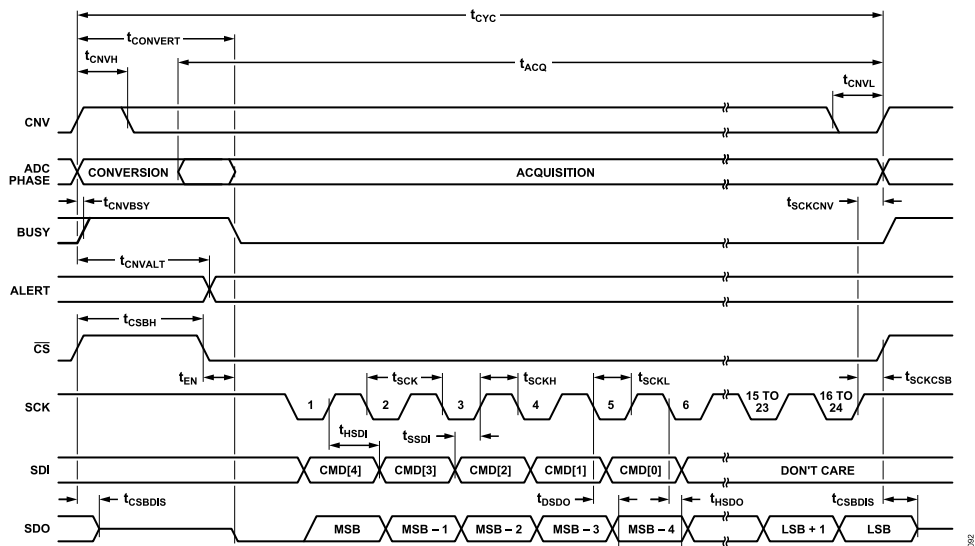

Figure 95. Conversion Mode Timing Diagram, Single-SDO Mode, SDO_STATE = 1

DIGITAL INTERFACE

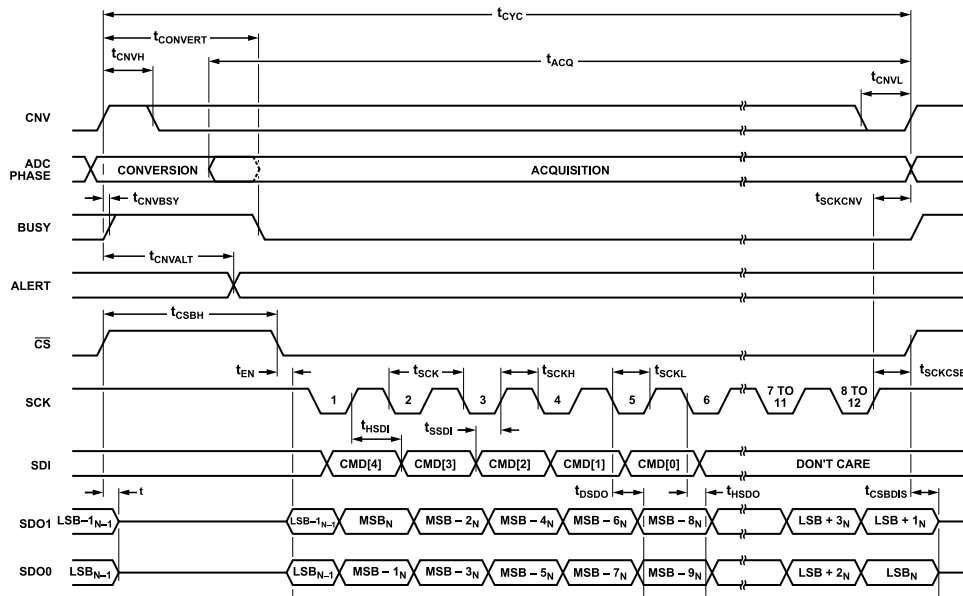

Figure 96. Conversion Mode Timing Diagram, Dual-SDO Mode, SDO_STATE = 0

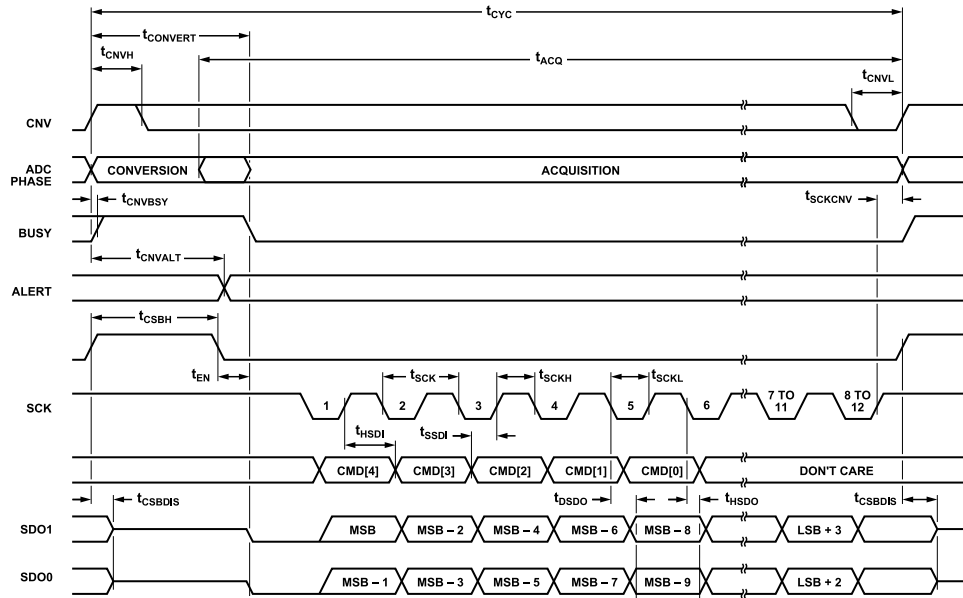

Figure 97. Conversion Mode Timing Diagram, Dual-SDO Mode, SDO_STATE = 1

DIGITAL INTERFACE

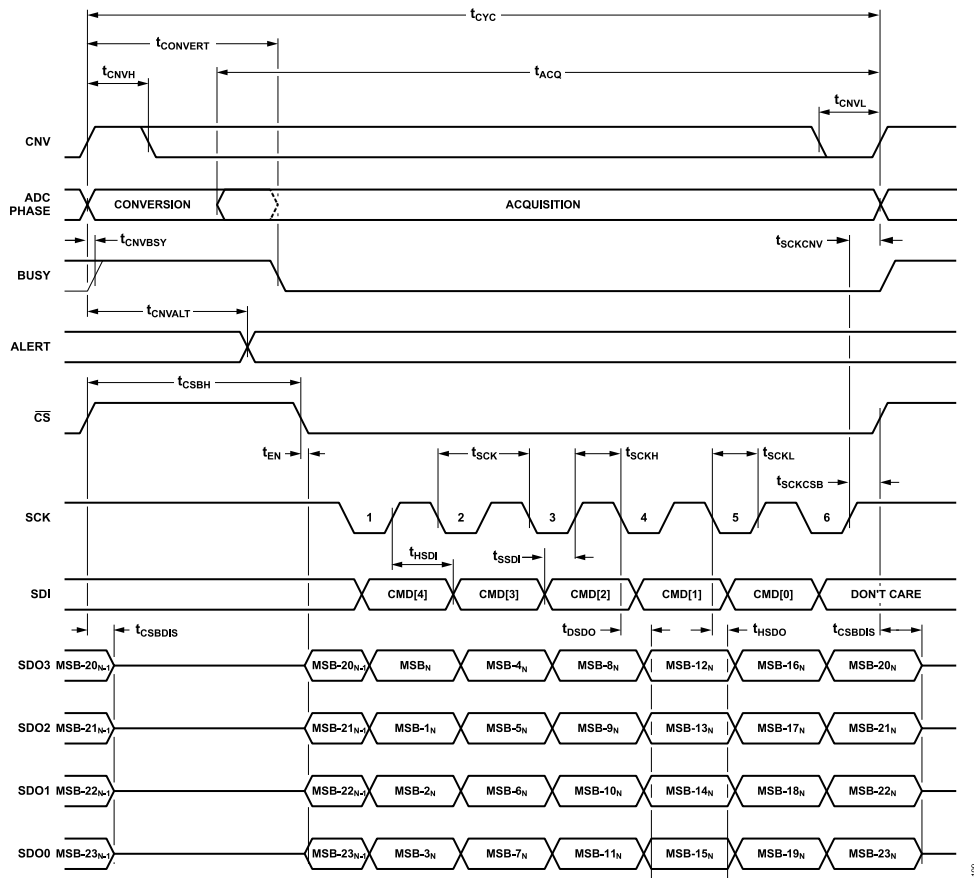

Figure 98. Conversion Mode Timing Diagram, Quad-SDO Mode, SDO_STATE = 0

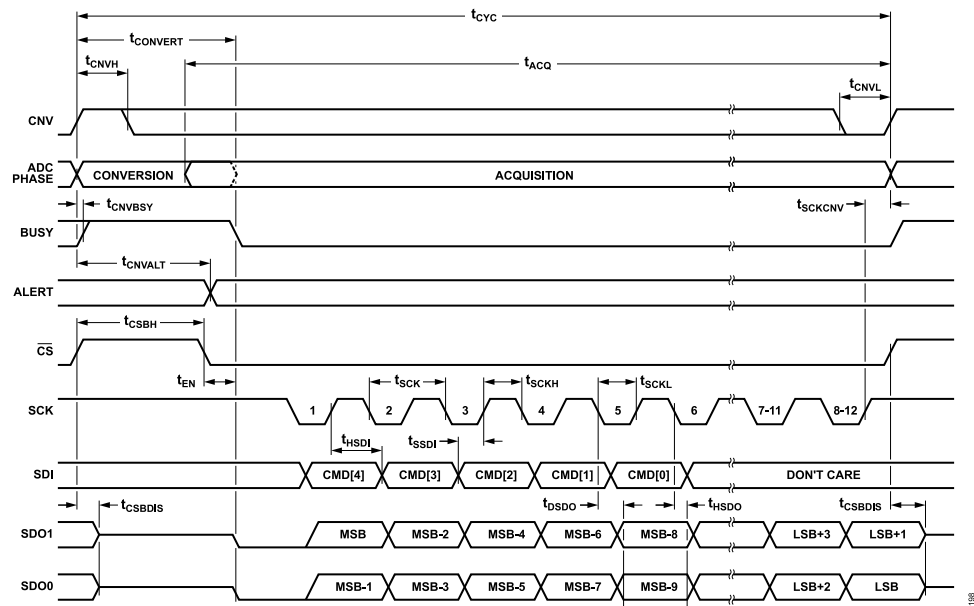

Figure 99. Conversion Mode Timing Diagram, Quad-SDO Mode, SDO_STATE = 1

DIGITAL INTERFACE

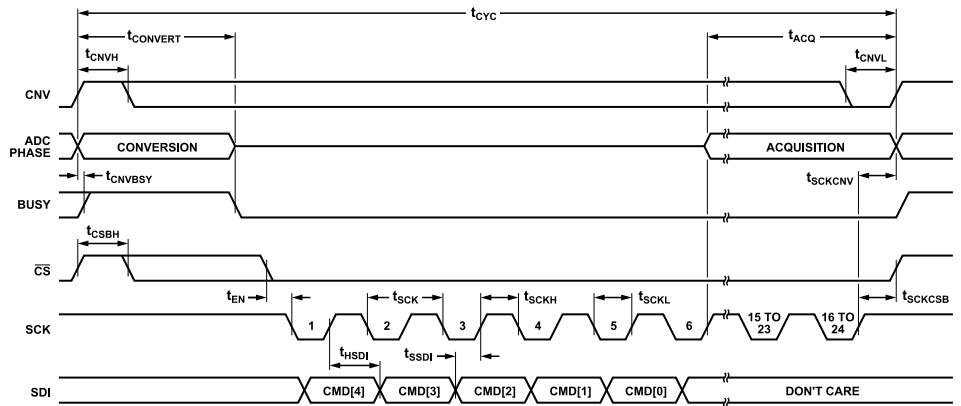

Figure 100. Conversion Mode Timing Diagram, Single-Cycle Command Mode Enabled

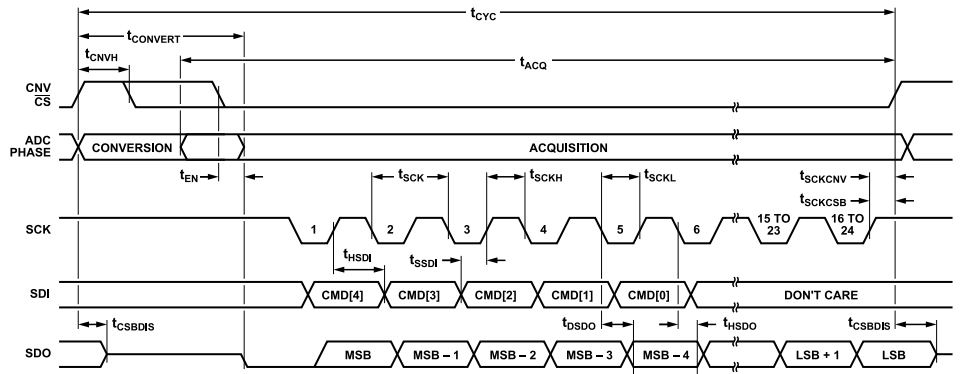

Figure 101. Conversion Mode Timing Diagram with 4-Wire SPI, Single-SDO Mode, SDO_STATE = 1

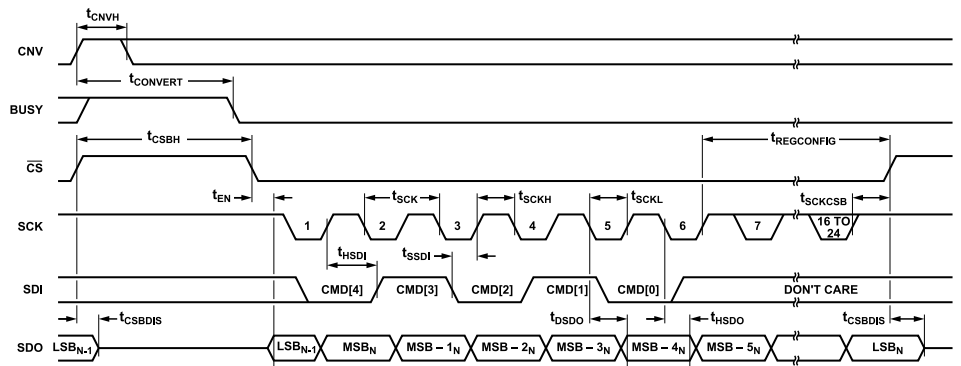

Figure 102. Conversion Mode Timing Diagram, Register Configuration Mode Command

AUTOCYCLE MODE

The AD4695/AD4696 can be configured to convert autonomously on a user-programmed channel sequence, which is the ideal mode of operation for system monitoring. When autcycle mode is enabled, the AD4695/AD4696 generate an internal clock that acts as the convert start signal, and the digital host is not required to generate a signal on CNV. The internal convert start clock is enabled when the AD4695/AD4696 enter conversion mode. The internal convert start clock is disabled when the AD4695/AD4696

enter register configuration mode. Therefore, conversions only occur when the AD4695/AD4696 are in conversion mode.

Autocycle mode can be used in conjunction with the busy indicator, threshold detection alerts, and the standard or advanced sequencers to reduce overhead for the digital host system. The threshold detection alert indicator can be assigned to a general-purpose pin and used as an interrupt to indicate a predetermined out of bounds event. The threshold detection interrupt service routine can optionally trigger an SPI instruction to read back the most

DIGITAL INTERFACE

recent conversion result and exit conversion mode to determine the specific type of out of bounds event using the alert indicator registers (ALERT_STATUS1 to ALERT_STATUS4).

Autocycle mode is intended to be used with the standard sequencer and advanced sequencer. Autocycle mode can optionally be used with two-cycle command mode and single-cycle command mode, but the digital host must transmit the 5-bit SDI commands for selecting channels.

Autocycle mode is enabled when the AC_EN bit in the AC_CTRL register is set to 1. There are eight options for the period of the internal convert start signal. The convert start signal period is selected with the AC_CYC bit field in the AC_CTRL register. Table 24 shows the conversion period and corresponding sample rates for each AC_CYC value.

Upon exiting autocycle mode and entering register configuration mode, it is recommended to reset the AD4695/AD4696 before reentering autocycle mode.

Table 24. Autocycle Mode Conversion Period Options

AC_CYC, Bits[2:0] Value	Conversion Period (μs)	Sample Rate (kSPS)
0x0	10	100
0x1	20	50
0x2	40	25
0x3	80	12.5
0x4	100	10
0x5	200	5
0x6	400	2.5
0x7	800	1.25

Note that the SPI transactions when autocycle mode is enabled must adhere to the timing specifications of conversion mode (see

the Conversion Mode section and Table 2). Figure 125 shows a timing diagram with the recommended general-purpose pin assignments to synchronize the digital host with the AD4695/AD4696 with autocycle mode enabled. Either the alert indicator or the busy indicator can be assigned to the general-purpose pins to determine when the digital host can initiate the SPI transaction; however, only the WLCSP options support assigning the alert and busy indicators to separate general-purpose pins. See the General-Purpose Pins section for a description of configuring the general-purpose pins to output the busy indicator and the alert indicator.

As shown in Figure 103, SPI transactions when using autocycle mode must not start before $t_{CONVERT}$ has elapsed. The busy indicator or the alert indicator must be used to ensure that the digital host is synchronized to the internal convert start clock (see the SPI Peripheral Synchronization in Autocycle Mode section). The SCK rate must also be fast enough to complete the desired SPI transaction before the next conversion begins (see the Conversion Mode SPI Clock Frequency Requirements section).

The t_{ACBSY} specification dictates how long the busy indicator is low between two conversions when autocycle mode is enabled. The t_{SCKCNV} specification dictates how much time must be given between the final SCK rising edge of the SPI transaction and the start of the next conversion.

The t_{CNVALT} specification indicates the delay between the start of the conversion and when the alert indicator state is updated. A rising edge of the alert indicator does not directly imply that the AD4695/AD4696 interface is ready for an SPI transaction, but can be used as an interrupt to trigger an SPI transaction if the transaction is completed before the remainder of t_{CYC} elapses.

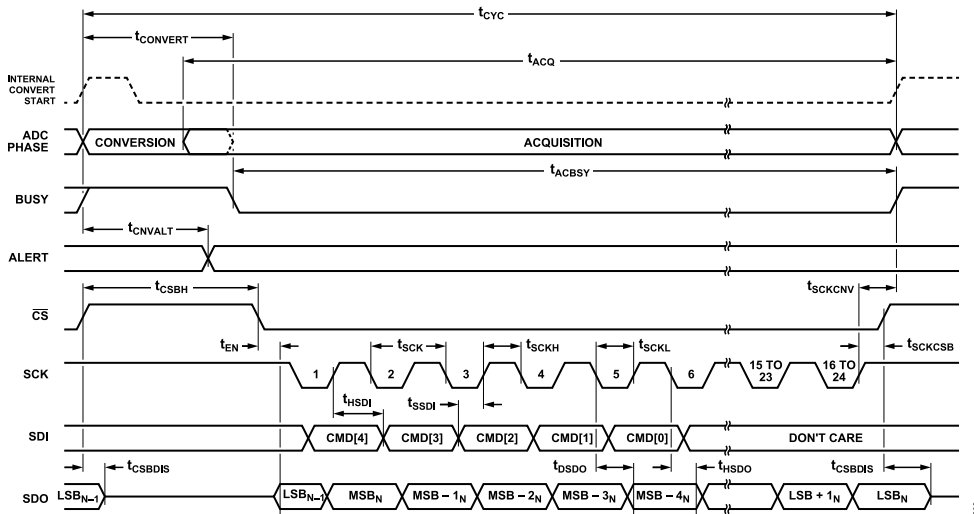

Figure 103. Conversion Mode Timing Diagram with Autocycle Mode Enabled (Single-SDO Mode, SDO_STATE = 0)

DIGITAL INTERFACE

GENERAL-PURPOSE PINS

Table 25 shows the functions available on each of the general-purpose pins on the LFCSP and WLCSP options of the AD4695/AD4696, plus the relative priority of those functions (lower numbers indicate higher priority). To configure the general-purpose pins for a given function, all higher priority functions must be disabled. The [Busy Indicator](#) section, [Threshold Detection and Alert Indicators](#) section, [Serial Data Output Modes](#) section, and [GPIO](#) section describe the behavior of the general-purpose pins when they are configured for each function shown in Table 25.

The LFCSP option of the AD4695/AD4696 has one general-purpose pin named BSY_ALT_GP0. The WLCSP option of the

AD4695/AD4696 has four general-purpose pins, which are named BSY_ALT_GP0, GP1, GP2, and GP3. The BSY_ALT_GP0 pin on the LFCSP and the WLCSP options have the same available functions, except that it is not used as the SDO1 signal on the WLCSP (see Table 20 and Table 25).

When a general-purpose pin is configured for any function other than a general-purpose input, it functions as a digital output. If another device attempts to drive a general-purpose pin while it is configured as a digital output, contention occurs and could potentially damage the AD4695/AD4696. All AD4695/AD4696 general-purpose pins are configured as digital inputs by default.

Table 25. General-Purpose Pin Functions and Function Priority

Package	Pin	Function Priority			
		1 (Highest Priority)	2	3	4 (Lowest Priority)
LFCSP	BSY_ALT_GP0	SDO1 signal (dual-SDO mode)	Alert indicator	Busy indicator	GPIO
WLCSP	BSY_ALT_GP0	Alert indicator	Busy indicator	GPIO	
	GP1	SDO1 (dual-SDO and quad-SDO mode)	GPIO		
	GP2	SDO2 (quad-SDO mode)	Alert indicator	GPIO	
	GP3	SDO3 (quad-SDO mode)	Busy indicator	GPIO	

DIGITAL INTERFACE

GPIO

Each general-purpose pin can be configured as a general-purpose input/output (GPIO) using the GPIIn_EN and GPOn_EN bits in the GPIO_CTRL register, respectively (see [Table 53](#)). A general-purpose pin is configured as an input when its corresponding GPIIn_EN bit is set to 1 and is configured as an output when its corresponding GPOn_EN bit is set to 1.

The AD4695/AD4696 GPIO functionality allows the digital host to control logic inputs or monitor logic outputs of other devices in the system with the AD4695/AD4696 SPI instead of using additional digital host GPIO pins. The GPIO functionality is especially useful in digitally isolated applications because the functions reduce the number of required digital isolation channels.

When a general-purpose pin is configured as a general-purpose input, it can be connected to a logic output of another device in the system and the digital host can read the GPIO_STATE register to monitor its state. The GPI_READ bit field in the GPIO_STATE register indicates the state of each general-purpose input (see [Table 55](#)). The logic input thresholds for the general-purpose inputs are specified in [Table 1](#) as V_{IL} and V_{IH} .

When a general-purpose pin is configured as a general-purpose output, it can be connected to a logic input of another device in the system, such as other multiplexers or programmable gain amplifiers, and the digital host can write to the GPIO_STATE register to set the state of this signal. The GPO_WRITE bit field in the GPIO_STATE register controls the state of the general-purpose outputs (see [Table 55](#)). The logic output thresholds for the general-purpose outputs are specified in [Table 1](#) as V_{OL} and V_{OH} .

Because the LFCSP option does not have the GP1, GP2, or GP3 pins, the corresponding GPI_READ bits are hard-coded to 0, and writing to the corresponding GPO_WRITE bits have no effect.

DEVICE RESET

A device reset reinitializes the AD4695/AD4696 configuration registers. The AD4695/AD4696 provide several options for performing a device reset, including a hardware reset, a software reset, and PORs.

Hardware resets, software resets, and PORs all assert the RESET_FLAG bit in the status register. The RESET_FLAG bit is a read to clear bit and is automatically set to 0 after a valid read from the status register. The RESET_FLAG bit can be used by the digital host to confirm that the device has executed a device reset, or if a reset was performed unintentionally.

All device reset methods require a delay between the start of the reset instruction and when the AD4695/AD4696 SPI is ready to receive communications from the digital host. The device reset delays are shown in [Figure 104](#) through [Figure 111](#) and in [Table 2](#). When the digital host attempts to perform an SPI read or write transaction before the device is ready, the transaction is considered invalid and the NOT_RDY_ERROR bit in the SPI_STATUS register

is set to 1. The NOT_RDY_ERROR bit is a R/W1C bit and is only reset when set to 1 with a valid register write transaction.

Hardware Reset

A hardware reset is initiated by the $\overline{\text{RESET}}$ falling edge. [Figure 104](#) shows a timing diagram for performing a hardware reset. t_{RESETL} is the minimum amount of time that $\overline{\text{RESET}}$ must be driven low, and $t_{\text{HWR_DELAY}}$ is the time that the digital host must wait between a $\overline{\text{RESET}}$ falling edge and starting an SPI frame (see [Table 2](#)).

If the internal LDO supplies VDD, and the internal LDO is disabled before a hardware reset, the internal LDO is enabled by the hardware reset and an additional delay is required to account for the internal LDO output reaching the VDD minimum required voltage (see the [Power-On Resets \(PORs\)](#) section).

Software Reset

To initiate a software reset, set the SW_RST_MSB bit and SW_RST_LSB bit in the SPI_CONFIG_A register to 1. A software reset reinitializes the state of all configuration registers listed in the [Register Information](#) section to the default values, except for the SPI_CONFIG_A register. When the software reset is complete, the SW_RST_MSB bit and SW_RST_LSB bit automatically clear. [Figure 105](#) shows the timing requirements for performing a software reset. $t_{\text{SWR_DELAY}}$ is the time that the digital host must wait between the software reset and starting a new SPI frame (see [Table 2](#)).

Power-On Resets (PORs)

A POR is initiated when VDD or VIO is first supplied. When a POR event is detected, the AD4695/AD4696 configuration registers are initialized to the default values, but it is still recommended to perform either a hardware reset or a software reset after a POR.

[Figure 106](#) shows a timing diagram of a VDD POR where VIO is already supplied. $t_{\text{POR_VDD}}$ is the time that the digital host must wait between VDD first being supplied and starting an SPI frame (see [Table 2](#)). [Figure 107](#) shows a timing diagram of a VIO POR where VDD is already supplied. $t_{\text{POR_VIO1}}$ is the time that the digital host must wait between VIO first being supplied and starting an SPI frame (see [Table 2](#)).

When VDD is supplied by the internal LDO, the VDD POR is triggered when the internal LDO output drives VDD to at least the minimum VDD specification. The internal LDO output is only enabled when both LDO_IN and VIO are supplied, and when the LDO_EN bit in the SETUP register is set to 1 (see the [Internal LDO](#) section).

[Figure 108](#) shows a timing diagram of an LDO_IN POR where VIO is already supplied. $t_{\text{POR_LDO}}$ is the time that the digital host must wait between LDO_IN first being supplied and starting an SPI frame.

DIGITAL INTERFACE

Figure 109 shows a timing diagram of a VIO POR where the internal LDO is used to supply VDD. t_{POR_VIO2} is the time that the digital host must wait between VIO being supplied and starting an SPI frame.

When the internal LDO supplies VDD, a POR occurs when the internal LDO is enabled by the LDO wake-up command or by a hardware reset if the internal LDO was previously disabled (LDO_EN bit = 0). Figure 110 shows a timing diagram of a POR where the internal LDO is enabled by the LDO wake-up command. t_{WAKEUP_SW} is the time that the digital host must wait between the LDO wake-up command and starting a new SPI frame. Figure

111 shows a timing diagram of a POR where the internal LDO is enabled by a hardware reset. t_{WAKEUP_HW} is the time that the digital host must wait between the hardware reset and starting an SPI frame.

t_{POR_LDO} , t_{POR_VIO2} , t_{WAKEUP_HW} , and t_{WAKEUP_SW} all depend on the VDD decoupling capacitance (C_{VDD}). Larger values of C_{VDD} increase the amount of time it takes for the internal LDO output voltage to reach the minimum VDD supply voltage to trigger a VDD POR. Table 2 provides typical values for these reset delay specifications with $C_{VDD} = 1 \mu F$.

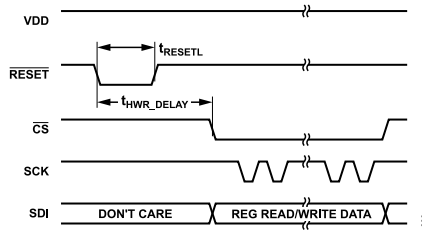

Figure 104. Hardware Reset Timing Diagram

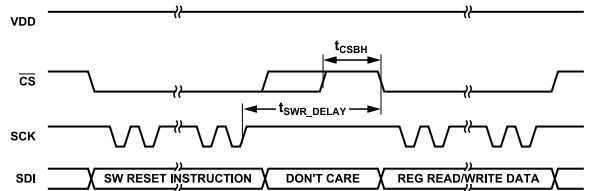

Figure 105. Software Reset Timing Diagram

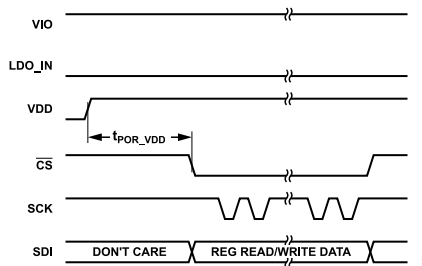

Figure 106. VDD POR Timing Diagram

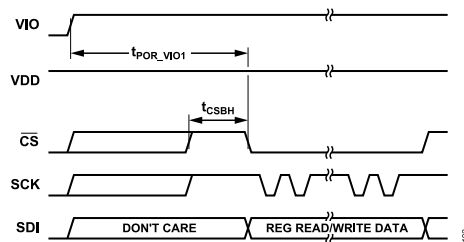

Figure 107. VIO POR Timing Diagram (VDD Supplied Externally)

DIGITAL INTERFACE

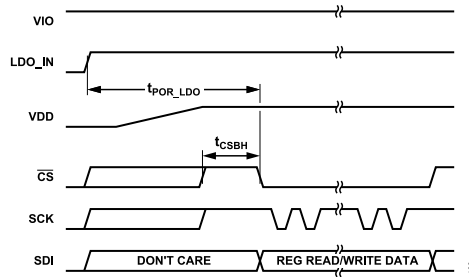

Figure 108. LDO_IN POR Timing Diagram (Internal LDO Supplying VDD)

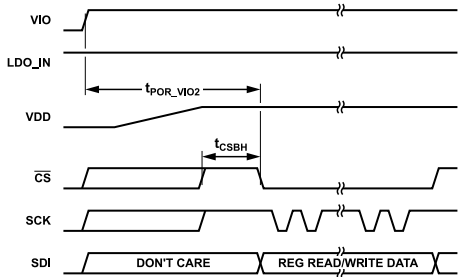

Figure 109. VIO POR Timing Diagram (Internal LDO Supplying VDD)

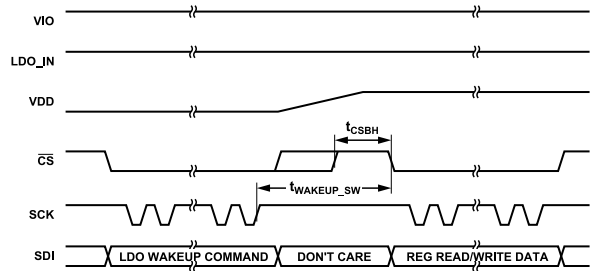

Figure 110. LDO Wake-Up Command POR Timing Diagram

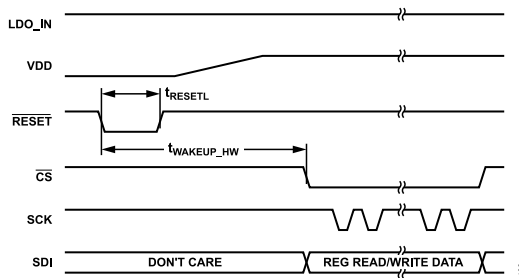

Figure 111. POR with Internal LDO Enabled by Hardware Reset Timing Diagram

APPLICATIONS INFORMATION

Figure 112 shows an example of the recommended connection diagram for the AD4695/AD4696 companion circuitry.

The AD4695/AD4696 companion circuitry includes power supplies, voltage reference circuitry, AFE signal conditioning, and an SPI-

compatible digital controller (plus optional digital isolation). The following sections provide recommendations and suggestions for selecting and connecting the AD4695/AD4696 companion circuitry based on common application requirements.

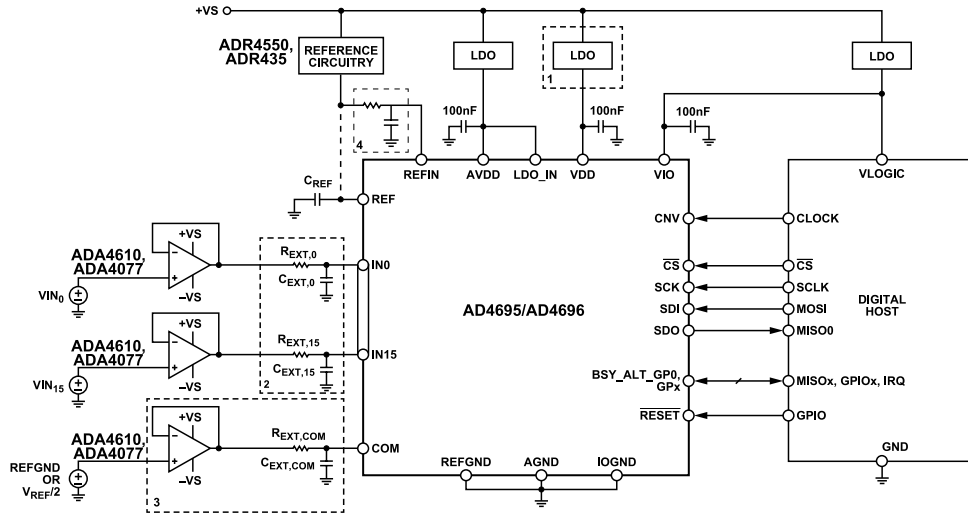

1. DEDICATED +1.8V SUPPLY FOR VDD NOT REQUIRED WHEN USING INTERNAL LDO
2. $R_{EXT,x}$ AND $C_{EXT,x}$ REPRESENT EXTERNAL INPUT RC FILTERS FOR ANALOG INPUT IN_x OR COM
3. CIRCUITRY NOT REQUIRED FOR COM INPUT WHEN CONNECTING COM TO REFGND
4. OPTIONAL RC FILTER BETWEEN VOLTAGE REFERENCE AND REFIN INPUT (REFERENCE BUFFER ENABLED ONLY)

Figure 112. Typical Connection Diagram

APPLICATIONS INFORMATION

ANALOG FRONT-END DESIGN

The AFE companion circuitry for the AD4695/AD4696 normally includes an external RC filter and an ADC driver or a precision operational amplifier between the signal being measured and the AD4695/AD4696 analog inputs.

The component selection and design of the AFE circuitry driving the AD4695/AD4696 analog inputs have a direct impact on overall system performance. The AFE must be designed with the system target noise, accuracy, distortion, and settling requirements of the end application. The following sections provide recommendations for designing AFE and signal conditioning circuits based on these requirements.

External RC Filter

The external RC low-pass filter consists of an external resistor and capacitor (represented by R_{EXT} and C_{EXT} in [Figure 66](#) and [Figure 112](#)). These components act to reduce the wideband noise from the AFE circuitry, reduce the nonlinear voltage kickback that occurs at the analog inputs, and protect the analog inputs from overvoltage events. Selecting the appropriate R_{EXT} and C_{EXT} values for these functions is described in the [Analog Front-End Noise Considerations](#) section, the [Signal Settling Requirements](#) section, and the [Analog Input Overvoltage Protection](#) section.

Ensure that the C_{EXT} capacitor is an NP0 ceramic capacitor to limit distortion artifacts, and that the PCB layout minimizes the parasitic impedance between C_{EXT} and the analog input pin. See the [Layout Guidelines](#) section for more information.

Signal Settling Requirements

As described in the [Converter Operation](#) and [Analog Inputs](#) sections, the AD4695/AD4696 analog inputs (IN0 to IN15 and COM) are routed to the ADC core inputs via the internal analog multiplexer.

As shown in [Figure 66](#), the ADC core capacitive DAC can be represented by a switched capacitive load.

At the start of the conversion phase, the multiplexer switches are disconnected and the voltage on the currently selected analog input channel is sampled on the capacitive DAC. During the acquisition phase, the multiplexer switches (SW_{MUX+} and SW_{MUX-}) close to connect the next selected analog input channel to the capacitive DAC. A voltage glitch (commonly referred to as kickback) occurs when these switches close due to the difference between the voltage on the capacitive DAC and the voltage on the selected analog input pins.

To achieve specified performance of the AD4695/AD4696, this kickback must be settled to within half an LSB of the ADC core before the start of the next conversion phase (that is, the next CNV rising edge). The rate at which the kickback voltage is settled depends on the transient characteristics and bandwidth of the analog front-end circuitry. Signal settling requirements therefore dictate the minimum allowable analog front-end bandwidth and constrain the driver amplifier and external RC filter selection.

[Table 26](#) provides a list of recommended amplifiers and external RC filter components for various sample rates and signal bandwidths. [Figure 71](#) and [Figure 72](#) in the [Analog Input High-Z Mode](#) section show SNR and THD performance with various amplifiers and external RC component values.

Analog input high-Z mode significantly reduces the bandwidth requirements of the analog front end by minimizing the size of the voltage kickback. [Figure 21](#) shows the difference in magnitude of the kickback when analog input high-Z mode is disabled and enabled.

Analog Front-End Noise Considerations

The magnitude of the AFE noise directly impacts the dynamic range and SNR performance of the overall AD4695/AD4696 signal chain. Select the AFE components and configuration to achieve the target noise specification for the overall system.

[Figure 113](#) illustrates the primary noise sources in a typical analog front-end driver circuit.

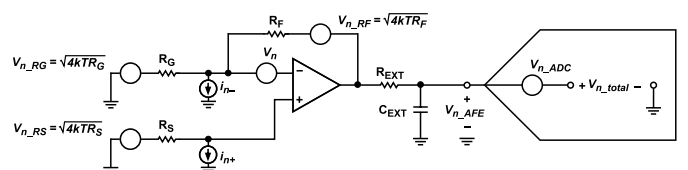

Figure 113. Noise Sources in Typical ADC Analog Front-End Circuit

APPLICATIONS INFORMATION

Assuming all noise sources are Gaussian and uncorrelated, the total system rms noise (v_{n_total}) is calculated as follows:

$$v_{n_total} = \sqrt{V_{n_AFE}^2 + V_{n_ADC}^2} \quad (9)$$

where:

v_{n_AFE} is the referred to output (RTO) rms noise of the AFE.

v_{n_ADC} is the AD4695/AD4696 input referred rms noise.

The estimated system dynamic range (DR_{total}) is a measure of the system rms noise and the full-scale input range.

$$DR_{total} = 20 \log \left(\frac{V_{REF}/(2\sqrt{2})}{v_{n_total}} \right) \quad (10)$$

The AD4695/AD4696 input referred rms noise specification (v_{n_ADC}) is typically 37.8 μ V rms (see Table 1). Figure 114 shows the typical system dynamic range vs. v_{n_AFE} with $v_{n_ADC} = 37.8 \mu$ V rms and $V_{REF} = 5$ V. For v_{n_AFE} less than 13 μ V rms, the overall system dynamic range remains within 0.5 dB of the AD4695/AD4696 dynamic range specification (see Table 1).

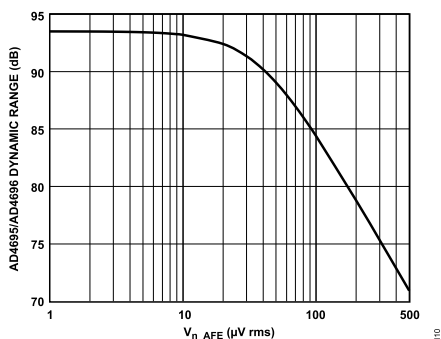

Figure 114. AD4695/AD4696 Typical Dynamic Range vs. v_{n_AFE} , $V_{REF} = 5$ V

$$v_{n_AFE} = ENBW_{RC} \times \sqrt{4kTR_F + \left(1 + \frac{R_F}{R_G}\right)^2 \left(4kTR_S + (i_{n+} \times R_S)^2 + v_n^2\right) + \left(\frac{R_F}{R_G}\right)^2 4kTR_G + (i_{n-} \times R_F)^2} \quad (12)$$

The AFE RTO noise (v_{n_AFE}) is equal to the rms noise of each of the constituent components in the AFE, referred to the output of the external RC filter (R_{EXT} and C_{EXT} in Figure 66 and in the External RC Filter section). Assuming the RC filter bandwidth is much lower than the bandwidth of the amplifier circuit, v_{n_AFE} is equal to the noise spectral density of each of these components (referred to the amplifier output) multiplied by the effective noise bandwidth of the RC filter ($ENBW_{RC}$), as shown in the following equations,

where:

k is the Boltzmann constant.

T is the absolute temperature in Kelvin.

R_F and R_G are the feedback network resistors, as shown in Figure 113.

R_S is the source resistance, as shown in Figure 113.

i_{n+} and i_{n-} represent the amplifier input current noise spectral density in pA/ \sqrt Hz.

v_n represents the amplifier input voltage noise spectral density in nV/ \sqrt Hz.

See MT-049 and MT-050 for detailed derivations of v_{n_AFE} vs. analog front-end components and configurations.

$$ENBW_{RC} = \sqrt{\frac{\pi}{2}} \times \frac{1}{2\pi R_{EXT} C_{EXT}} \quad (11)$$

APPLICATIONS INFORMATION

Analog Front-End Noise in Pseudobipolar Mode

When configuring a channel in pseudobipolar mode, typically a second AFE circuit is required to drive the negative-side input to $V_{REF}/2$ V (as described in the [Channel Configuration Options](#) section). In this case, the RTO rms noise of the additional analog front end (v_{n_AFE2}) is added to the rss equation to calculate the total system rms noise:

$$v_{n_total} = \sqrt{v_{n_AFE}^2 + v_{n_AFE2}^2 + v_{n_ADC}^2} \quad (13)$$

Note that the bandwidth of the RC filter and values of R_{EXT} and C_{EXT} cannot be set arbitrarily low due to the settling requirements of the AD4695/AD4696 analog inputs. Refer to the [Signal Settling Requirements](#) section for guidelines on selecting the optimal RC filter components for the target sample rate.

Guidelines for Driver Amplifier Selection

The following is a list of guidelines for selecting the amplifier(s) used in the AD4695/AD4696 AFE based on the end system requirements.

The amplifier voltage and current noise specifications must be sufficiently low to achieve the desired rms noise and dynamic range performance, as described in the [Analog Front-End Noise Considerations](#) section.

The distortion performance of the amplifier must be sufficient to achieve desired THD performance. To meet the AD4695/AD4696

THD data sheet specification, the amplifier circuit must have lower or comparable distortion specifications.

The small signal bandwidth of the amplifier must be sufficiently higher than the minimum bandwidth required to adequately settle the voltage steps that occur when switching between two analog input channels, as described in the [Signal Settling Requirements](#) section.

The amplifier must also have sufficient supply headroom to adequately output a full-scale signal to the AD4695/AD4696 analog inputs (see the input voltage range specification in [Table 1](#)). Refer to the input and output headroom requirements in the amplifier data sheet to determine the supply voltages required to support the desired full-scale range for the given channel.

The [ADA4805-1](#) and [ADA4807-1](#) and their dual- and quad-amplifier models are suitable amplifiers for channels acquiring ac waveforms, due to their exceptionally low noise and distortion and high bandwidth.

The [ADA4610-1](#) and [ADA4077-1](#) and their dual- and quad-amplifier models are suitable amplifiers for channels monitoring dc or low frequency signals that require high precision. It is recommended to enable analog input high-Z mode on the AD4695/AD4696 analog input channels when driven directly by the [ADA4610-1](#), [ADA4077-1](#), or amplifiers with similar bandwidth specifications to ensure adequate settling performance (see the [Signal Settling Requirements](#) section and [Analog Input High-Z Mode](#) section).

Table 26. Recommended Amplifier and External RC Filter Component Selection

Input Signal Bandwidth (kHz)	Sample Rate	Amplifier	R_{EXT} (Ω)	C_{EXT} (pF)
≤ 10	≤ 1 MSPS	ADA4805-1/ADA4805-2	390	180
		ADA4807-1/ADA4807-2/ADA4807-4	390	180
		ADA4610-1/ADA4610-2/ADA4610-4	680	180
		ADA4077-1/ADA4077-2/ADA4077-4	680	180
	≤ 500 kSPS	ADA4805-1/ADA4805-2	680	180
		ADA4807-1/ADA4807-2/ADA4807-4	680	180
		ADA4610-1/ADA4610-2/ADA4610-4	680	470
		ADA4077-1/ADA4077-2/ADA4077-4	680	470
> 10	≤ 1 MSPS	ADA4805-1/ADA4805-2	200	180
		ADA4807-1/ADA4807-2/ADA4807-4	200	180
		ADA4896-2	200	180
	≤ 500 kSPS	ADA4805-1/ADA4805-2	390	180
		ADA4807-1/ADA4807-2/ADA4807-4	390	180
		ADA4896-2	390	180

APPLICATIONS INFORMATION

ANALOG INPUT OVERVOLTAGE PROTECTION

The external resistor in the external RC filter (represented by R_{EXT} in [Figure 66](#), [Figure 112](#), and [Figure 115](#)) works with the input overvoltage protection clamps to provide overvoltage protection to the analog inputs (see the [Input Overvoltage Protection Clamps](#) section).

An overvoltage event is defined as an event where the overvoltage protection clamps are activated as a result of the input voltage on IN0 to IN15 or COM exceeding the clamp activation voltage specification (V_{ACT} in [Figure 115](#)). The maximum V_{ACT} voltage specification is $V_{REF} + 0.55\text{ V}$ (see [Table 1](#)).

When activated, the clamp on the given channel sinks current from the source to ground (see I_{CLAMP} in [Figure 115](#)), resulting in a voltage drop across R_{EXT} . The AD4695/AD4696 overvoltage protection clamps support a maximum sustained I_{CLAMP} current of 5 mA (see [Table 1](#)). R_{EXT} therefore isolates the analog input pin voltage from the applied voltage (v_{IN}). The maximum v_{IN} voltage that can be supported for a given analog input is a function of V_{REF} and R_{EXT} . The following relation gives the required value of R_{EXT} to limit the clamp current to the maximum supported current (5 mA) given the V_{REF} and maximum expected v_{IN} voltage:

$$R_{EXT} = \frac{v_{IN,max} - V_{REF}}{5\text{ mA}} \quad (\Omega) \quad (14)$$

For example, if the analog input source can swing to 7.5 V and $V_{REF} = 5\text{ V}$, R_{EXT} must be approximately 500 Ω to limit the clamp current to 5 mA. If this resistor is being sized based upon the clamping current limits, C_{EXT} must be carefully chosen to ensure adequate input bandwidth is achieved (see the [Analog Front-End Noise Considerations](#) and [Signal Settling Requirements](#) sections for more information).

The value of R_{EXT} also must be selected to ensure stability of the overvoltage protection clamp circuit, if desired. See the [Overvoltage Protection Clamp Stability](#) section for more information.

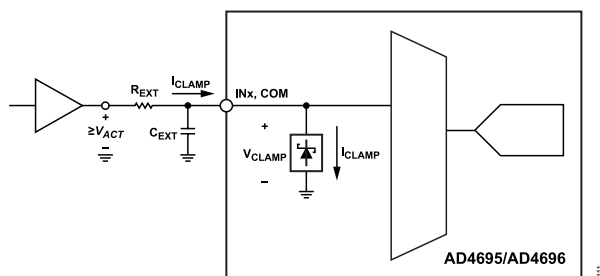

Figure 115. Analog Input Overvoltage Event

REFERENCE CIRCUITRY DESIGN

The AD4695/AD4696 V_{REF} sets the full-scale range of the ADC core and determines the resulting output code for a given analog input voltage (see the [Transfer Function](#) section). The V_{REF} voltage therefore has a direct impact on the overall system accuracy and ac performance. The reference companion circuitry for the AD4695/

AD4696 must have adequate noise performance, accuracy, drift and signal settling characteristics for the end application.

The REF input is a dynamic current load that pulls charge from the reference circuitry during the conversion phase of the ADC core, and the reference circuit must be able to maintain a stable V_{REF} while the ADC is performing conversions to maintain performance (that is, gain error).

The AD4695/AD4696 reference input high-Z mode significantly reduces the magnitude of the average current of the REF input when enabled. The WLCSP option of the AD4695/AD4696 also includes an optional internal reference buffer to provide a true buffered high impedance reference input. The reference input high-Z mode and internal reference buffer significantly reduce the drive requirements of the reference circuitry, allowing system designers to prioritize dc accuracy, power, and system footprint targets.

[Figure 116](#) shows the typical connection diagram for the AD4695/AD4696 companion reference circuit. The reference circuitry consists of a voltage reference, C_{REF} , and any accompanying reference buffer or analog low-pass filtering. A reference buffer is required if the selected voltage reference does not have an adequate load regulation to drive the REF input at the desired ADC sample rate (see the [Reference Circuit Design for Driving REF Input](#) section).

C_{REF} supplies the charge necessary for the ADC core to perform the bit trials as part of the conversion phase and filters noise from the other reference circuitry. C_{REF} must be sufficiently large to prevent deviations in V_{REF} during the ADC bit trials. When reference input high-Z mode is enabled, the amount of charge pulled by the REF input is significantly reduced, thereby reducing the minimum C_{REF} capacitance. When reference input high-Z mode is disabled, a 10 μF C_{REF} is recommended. When reference input high-Z mode is enabled, a 1 μF C_{REF} is recommended. C_{REF} is required whether reference input high-Z mode or the internal reference buffer is enabled or disabled.

The PCB layout of the reference circuitry relative to the AD4695/AD4696 REF input is critical to ensuring optimal performance. The [Layout Guidelines](#) section provides recommendations and guidelines for the layout of the reference circuit components.

Reference Circuit Design for Driving REF Input

[Figure 116](#) shows a typical connection diagram for the reference circuitry driving the REF input of the AD4695/AD4696.

The device driving the REF input must have sufficiently low output impedance so that the reference input current does not cause V_{REF} to deviate enough to violate the system performance targets. To achieve data sheet performance, V_{REF} must remain within half an LSB. The maximum output impedance of the device driving the REF input ($R_{o,max}$) is therefore:

APPLICATIONS INFORMATION

$$R_{o_max} = \frac{V_{REF}/2(16+1)}{I_{REF}} \quad (15)$$

where I_{REF} is the average REF input current.

Most voltage references specify load regulation in ppm/mA, which can be converted to effective output impedance with the following:

$$L_{max} = 1000 \times \frac{R_{o_max}}{V_{REF}} \quad (16)$$

where L_{max} is the load regulation specification for the voltage reference in ppm/mA that corresponds to the calculated R_{o_max} .

I_{REF} is typically 11 μ A at 1 MSPS with reference input high-Z mode enabled and 320 μ A at 1 MSPS with reference input high-Z mode

disabled (in unipolar mode). I_{REF} scales linearly with the ADC sample rate (see Table 1 and Figure 40). The output impedance and load regulation requirements of the reference circuitry are therefore less strict at lower sample rates. Table 27 shows calculated R_{o_max} and L_{max} for $V_{REF} = 5$ V and for different sample rates and with reference input high-Z mode disabled and enabled. Table 27 also provides recommendations for voltage references and discrete reference buffers for each of these conditions.

When driving the REF input on the WLCSP option of the AD4695/AD4696, the internal reference buffer must be disabled and the reference buffer bypass switch must be open (see SW_{BP} in Figure 74). The internal reference buffer is disabled by default ($REFBUF_EN = 0$) and the SW_{BP} is open by default ($REFBUF_BP = 0$).

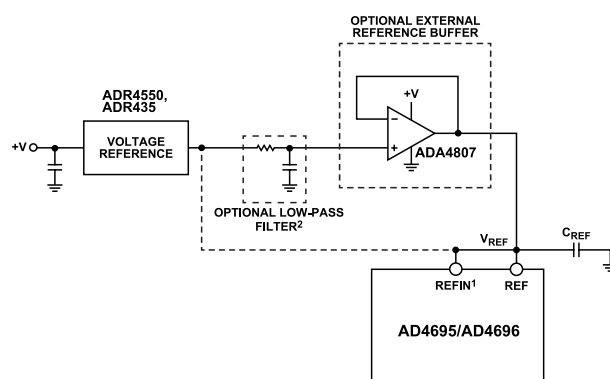

¹WHEN DRIVING REF DIRECTLY ON WLCSP OPTION, SHORT REFIN TO REF AND ENSURE THE INTERNAL REFERENCE BUFFER AND REFERENCE BUFFER BYPASS OPTION ARE DISABLED. ($REFBUF_EN = REFBUF_BP = 0$)

²ADDITIONAL LOW-PASS FILTERING MUST NOT BE IMPLEMENTED WITHOUT A REFERENCE BUFFER. 12

Figure 116. Typical Connection Diagram for Driving REF Input

Table 27. Reference Circuitry Recommendations, REF Input

Sample Rate	Reference Input		I_{REF} (μ A)	R_{o_max} (Ω)	L_{max} (ppm/mA)	Recommended Voltage References and Reference Buffers
	High-Z Mode					
1 MSPS	Disabled		320	0.12	24	ADR4550 with ADA4807-1, ADR445 with ADA4807-1, ADR435
1 MSPS	Enabled		12	3.2	640	ADR4550, ADR445, ADR435
500 kSPS	Disabled		160	0.24	48	ADR445 with ADA4807-1, ADR4550, ADR435
500 kSPS	Enabled		6	6.4	320	ADR4550, ADR445, ADR435

APPLICATIONS INFORMATION

Reference Circuit Design for Internal Reference Buffer

REFIN is the input to the AD4695/AD4696 internal reference buffer (available on the WLCSP option only). The internal reference buffer provides a true high impedance input for directly interfacing a precision voltage reference to the AD4695/AD4696.

Figure 117 shows a typical connection diagram for interfacing external reference circuitry with the internal reference buffer. The voltage reference drives the REFIN input, and the REF input is connected only to the reference decoupling capacitor (C_{REF}).

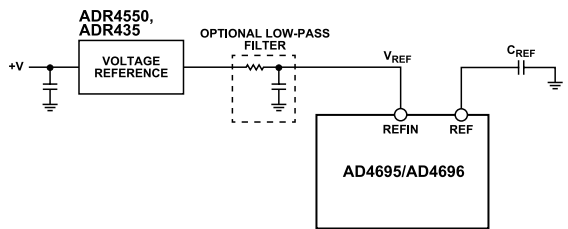

Figure 117. Typical Connection Diagram for Driving REFIN Input

The typical input leakage current of the REFIN input is 16 nA when the internal reference buffer is enabled (see Table 1). Using the equations for R_{o_max} and L_{max} in the Reference Circuit Design for Driving REF Input section, for a 4.096 V reference, half LSB accuracy is maintained for an effective series resistance of 2.3 k Ω . Optional low-pass filtering can be implemented between the voltage reference output and the REFIN input to reduce wideband noise, as long as the effective series resistance of the filter combined with the output impedance of the connected voltage reference maintain adequate accuracy in V_{REF} .

Reference input high-Z mode must be enabled when utilizing the internal reference buffer ($REFHIZ_EN = 1$). The internal reference buffer is disabled by default, and must be enabled on device power-up and after device resets. When the internal reference buffer is first enabled by setting $REFBUF_EN$ to 1, the internal reference buffer charges C_{REF} until it reaches the V_{REF} voltage. See the Optimizing Reference Buffer Startup section for a description of the AD4695/AD4696 configuration settings that determine the amount of time required for the internal reference buffer to settle the V_{REF} voltage on startup.

The internal reference buffer is supplied from the AD4695/AD4696 AVDD supply, and when the internal reference buffer is enabled, V_{REF} must be at most $AVDD - 0.3$ V (see Table 1).

OPTIMIZING REFERENCE BUFFER STARTUP

When using the AD4695/AD4696 internal reference buffer, the REF input is disconnected from external reference circuitry and is only connected to the external reference decoupling capacitor (C_{REF} in Figure 117). When the internal reference buffer is disabled, C_{REF} slowly discharges. As a result, if the voltage across C_{REF} is not equal to the REFIN voltage when the internal reference buffer is first enabled, the internal reference buffer output current spikes until

it has sourced enough charge to C_{REF} . The process of charging C_{REF} incurs both a time delay before accurate conversions can be performed and a spike in the AVDD supply current. Suggestions for optimizing the delay and the peak supply current when enabling the internal reference buffer follow.

The internal reference buffer turn-on time specification in Table 1 is defined as the time required for the internal reference buffer to drive the REF pin from 0 V to V_{REF} within 0.01% accuracy. Larger C_{REF} capacitors and V_{REF} voltages require more charge to be driven into C_{REF} , and as a result, the internal reference buffer turn-on time is proportional to C_{REF} and V_{REF} . Figure 44 shows typical reference buffer output settling for $V_{REF} = 4.096$ V for several common values of C_{REF} .

The internal reference buffer is powered by the AVDD supply. While the internal reference buffer sources current into C_{REF} , an equal amount of current is drawn through AVDD. Higher internal reference buffer output currents therefore reduce the internal reference buffer turn-on time but increase the peak AVDD current until the REF pin voltage is settled to V_{REF} . The AD4695/AD4696 provide several options for enabling the internal reference buffer to either optimize turn-on time or peak current consumption.

Reference Buffer Startup with Bypass Option

The internal reference buffer bypass option is recommended to reduce the AVDD peak current when first enabling the internal reference buffer (for example, on device power-up). The internal reference buffer bypass option connects REFIN to REF without enabling the internal reference buffer, allowing the voltage reference driving REFIN to charge C_{REF} to V_{REF} while the internal reference buffer is disabled. This option ensures that the voltage on the REF input is closer to the target V_{REF} voltage before the internal reference buffer is enabled, reducing the magnitude of the internal reference buffer peak output current, and therefore, the resulting peak AVDD current.

When using the internal reference buffer bypass option to charge C_{REF} after initially powering on the device, take the following steps:

1. Write to the REF_CTRL register to set the REFBUF_EN bit to 0 and the REFBUF_BP bit to 1 to close SW_{BP} and bypass the internal reference buffer. ($REFBUF_EN$ is set to 0 on device power-up.)
2. Configure the rest of the device configuration registers before enabling the internal reference buffer to give the voltage reference circuitry time to charge C_{REF} .
3. Write to the REF_CTRL register to set the REFBUF_EN bit to 1 and the REFBUF_BP bit to 0 to open SW_{BP} and enable the internal reference buffer.

The internal reference buffer bypass option is also recommended for applications where the AD4695/AD4696 are idle (not converting) for long periods of time to reduce power consumption, because this option allows power cycling of the internal reference buffer while

APPLICATIONS INFORMATION

maintaining the desired V_{REF} . To implement the internal reference buffer power cycling scheme,

1. Disable and bypass the internal reference buffer when the ADC is idle by setting REFBUF_EN to 0 and REFBUF_BP to 1.
2. Enable and reconnect the internal reference buffer when the ADC needs to convert by setting REFBUF_EN to 1 and REFBUF_BP to 0.

Reference Buffer Startup with Boost Mode

The reference buffer boost mode increases the maximum output current of the internal reference buffer, therefore reducing the time required for the internal reference buffer to charge C_{REF} to the target V_{REF} voltage. Figure 44 shows the charging of C_{REF} vs. time when boost mode is enabled vs. when it is disabled for common values of C_{REF} .

The internal reference buffer boost mode increases the peak AVDD supply current while charging up C_{REF} . For systems that require the fastest possible device startup and can tolerate additional AVDD peak supply current, it is recommended to enable the internal reference buffer boost mode at the same time as enabling the internal reference buffer (REFBUF_EN = REFBUF_BOOST = 1).

CONVERTING BETWEEN CODES AND VOLTS

The [Transfer Function](#) section describes the ideal transfer function between the analog input voltage sampled by the AD4695/AD4696 ADC core and the resulting output code. The analog input voltage (V_{INx}) corresponding to each possible output code value ($CODE_{OUT}$) is a function of the V_{REF} voltage and the OSR setting and polarity mode for the selected channel:

$$V_{INx} = LSB \times CODE_{OUT} = \frac{V_{REF}}{2^N} \times CODE_{OUT} \quad (17)$$

where:

LSB is the LSB size.

N is the resolution of the output code.

The AD4695/AD4696 ADC core outputs 16-bit results ($N = 16$), but the output code resolution is a function of the OSR selected for the given channel (DR):

$$N = 16 + \log_4(OSR) \quad (18)$$

OSR can be set to 1, 4, 16, or 64, which correspond to an output code resolution of 16, 17, 18, and 19, respectively. Table 9 through Table 12 show the negative and positive full-scale output code values for each OSR. See the [Oversampling and Decimation](#) section for details on configuring the OSR for each channel.

The polarity mode for the selected channel determines whether $CODE_{OUT}$ uses straight binary or twos complement format. When unipolar mode is selected, $CODE_{OUT}$ is in straight binary, and is therefore an unsigned integer value. When pseudobipolar mode is selected, $CODE_{OUT}$ uses twos complement encoding, and is there-

fore a signed integer value. See the [Channel Configuration Options](#) for details on configuring the polarity mode for each channel.

The offset and gain correction settings for each channel modify the transfer function of the AD4695/AD4696 to correct for first-order inaccuracies in the system that cause the observed transfer function to deviate from the ideal. Update the offset and gain fields for each channel during system calibration. The [Offset and Gain Correction](#) section describes how the offset and gain fields modify the AD4695/AD4696 transfer function.

OVERSAMPLING FOR NOISE REDUCTION

The AD4695/AD4696 include on-chip oversampling and decimation as a means to reduce the total effective Gaussian noise of the system in the digital domain (see the [Oversampling and Decimation](#) section). Assuming the AFE noise is Gaussian, the effective system noise after oversampling (v_{n_OSR}) is:

$$v_{n_OSR} = \frac{v_{n_total}}{\sqrt{OSR}} \quad (19)$$

where OSR is the oversampling ratio setting for the given analog input channel and v_{n_total} is the RTO system noise (defined in the [Analog Front-End Noise Considerations](#) section). When the OSR is set to 1, no oversampling occurs, and the effective noise remains v_{n_total} . When OSR settings of 4, 16, and 64 are used, the noise is attenuated by a factor of 2, 4, and 8, respectively.

The resulting dynamic range when utilizing oversampling (DR_{OSR}) is as follows:

$$DR_{OSR} = DR_{total} + 10\log(OSR) \quad (20)$$

where DR_{total} is the system dynamic range for an OSR of 1 (defined in the [Analog Front-End Noise Considerations](#) section).

The effective number of bits (ENOB) of the system increases by 1 every time the noise is halved. As a result, ENOB increases by 1 bit every time the OSR is increased by a factor of 4. To reflect this, when an AD4695/AD4696 channel is configured with OSR settings of 4, 16, or 64, the resolution of the conversion results for that channel is extended to 17 bits, 18 bits, and 19 bits, respectively (see the [Transfer Function](#) section and [Serial Data Output Modes](#) section).

Note that oversampling and decimation only reduce voltage noise for uniformly distributed Gaussian noise sources and have no effect on other types of noise sources (such as 1/f noise).

DIGITAL INTERFACE OPERATION

Figure 112 shows a typical connection diagram of the AD4695/AD4696 digital interface connected to a digital host. The AD4695/AD4696 can be operated by a single 4-wire SPI-compatible host, but some features require additional digital resources, such as GPIOs and timers.

APPLICATIONS INFORMATION

The following sections provide recommendations for digital interface connections and operation to interact with the AD4695/AD4696 interface and feature set.

ADC Convert Start Signal Options

The CNV input is analogous to an edge triggered interrupt pin, which instructs the AD4695/AD4696 ADC core to perform a conversion (see the [Converter Operation](#) section). The CNV input is active only when the AD4695/AD4696 are in conversion mode and is ignored when in register configuration mode. The period of the signal driving the CNV input sets the sample rate of the AD4695/AD4696, and must conform to the t_{CYC} specification in [Table 2](#) and in [Figure 94](#) through [Figure 100](#).

The ADC core samples the analog input voltage on the selected channel on the rising edge of CNV. The signal driving the CNV input therefore must have sufficiently low jitter and fast edge rates to achieve the desired noise performance at the target input frequencies. The layout of the trace connecting the AD4695/AD4696 CNV input to the digital host must be as short as possible with minimal vias to minimize trace impedance (see the [Layout Guidelines](#) section).

In conversion mode, the digital host SPI peripheral must be synchronous to the CNV signal and follow the timing requirements specified in the [Conversion Mode Timing Diagrams](#) section. See the [SPI Peripheral Synchronization in Conversion Mode](#) section for recommendations for maintaining proper SPI timing.

Embedded clock divider or timer peripherals can typically output an integer division of the system clock. When utilizing embedded clock divider peripherals, connect the digital host clock output to CNV and set the clock output frequency to the desired sample rate. The clock output must be enabled while the AD4695/AD4696 are in conversion mode, but it can be either enabled or disabled while in register configuration mode.

The CNV input can be connected to the \overline{CS} output of the host SPI peripheral, provided the \overline{CS} rising edge timing is deterministic and periodic (see [Figure 121](#)). Note that for OSR settings greater than 1, multiple CNV rising edges are required before the result is available to be read out on the SPI (see the [Oversampling and Decimation](#) section). The SPI outputs all 0s during the CNV/ \overline{CS} frames prior to the oversampled data being ready.

An external crystal oscillator with a CMOS clock driver can also drive the CNV input. With this option, either the oscillator output or the busy indicator from the AD4695/AD4696 must be routed to the digital host and used as a timer or interrupt trigger to achieve synchronization between the CNV signal and the host SPI peripheral (see the [SPI Peripheral Synchronization in Conversion Mode](#) section).

Note that when autcycle mode is enabled, the CNV input is ignored, and conversions are instead triggered by an internal timer in the AD4695/AD4696, as described in the [Autocycle Mode](#) section. When exclusively using autcycle mode, the CNV input must be

tied to IOGND. The busy indicator is required to synchronize the AD4695/AD4696 to the host SPI peripheral when using autcycle mode (see the [SPI Peripheral Synchronization in Autocycle Mode](#) section).

SPI Peripheral Connections

The AD4695/AD4696 offer multiple serial data output modes that allow for one, two, or four main in, subordinate out (MISO) lines to output conversion results (see the [Serial Data Output Modes](#) section). When single-SDO mode is selected, only the SDO pin functions as a serial data output. When dual-SDO mode or quad-SDO mode is selected, the general-purpose pins are assigned as additional serial data outputs to implement multiple data lanes.

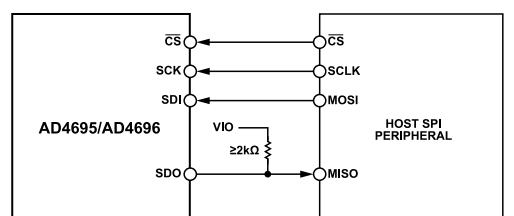
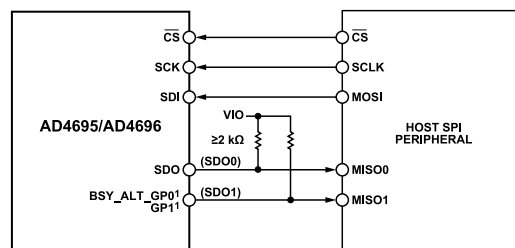

Figure 118. AD4695/AD4696 SPI Connection Diagram (Single-SDO Mode)

Figure 118 shows a connection diagram for interfacing the AD4695/AD4696 SPI to the digital host SPI peripheral when configured in single-SDO mode. It is recommended to include a pull-up resistor (2 kΩ minimum) to VIO on the SDO line, especially when the busy indicator is enabled on SDO (see the [Busy Indicator on Serial Data Outputs](#) section).



¹BSY_ALT_GP0 FUNCTIONS AS SDO1 ON LFCSP OPTION.
GP1 FUNCTIONS AS SDO1 ON WLCSP OPTION.

Figure 119. AD4695/AD4696 SPI Connection Diagram (Dual-SDO Mode)

Figure 119 shows a connection diagram for interfacing the AD4695/AD4696 SPI to a digital host SPI peripheral when configured in dual-SDO mode. Route BSY_ALT_GP0 to the second MISO input on the digital host (MISO1). It is recommended to include pull-up resistors on both SDO0 and SDO1 lines, especially when the busy indicator is enabled on the serial data outputs (see the [Busy Indicator on Serial Data Outputs](#) section).

APPLICATIONS INFORMATION

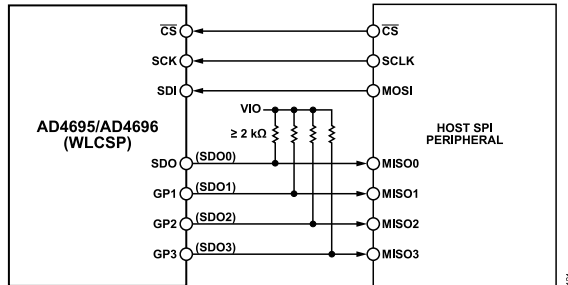

Figure 120. AD4695/AD4696 SPI Connection Diagram (Quad-SDO Mode)

Figure 120 shows a connection diagram for interfacing the AD4695/AD4696 SPI to a digital host SPI peripheral when configured in quad-SDO mode (available on the WLCSP option only). Table 19 shows the general-purpose pin assignments on the LFCSP and WLCSP options for dual-SDO mode and quad-SDO mode. Route the pins assigned as SDO1, SDO2, and SDO3 to the additional MISO inputs on the digital host (MISO1, MISO2, and MISO3, respectively).

It is recommended to include pull-up resistors on all pins assigned as serial data outputs as shown in Table 19, especially when the busy indicator is enabled on SDO (see the [Busy Indicator on Serial Data Outputs](#) section). It is also recommended to include pull-up resistors on the \overline{CS} , SCK, and SDI lines if the outputs on the host SPI peripheral are expected to be tristate or undefined during operation. The specific value of the pull-up resistors must be determined based on the edge rate requirements and trace capacitance for each line.

SPI Peripheral Synchronization in Conversion Mode

The AD4695/AD4696 have a 4-wire SPI in SPI Mode 3 for accessing register contents and ADC results. The digital host must at minimum include a 4-wire SPI-compatible peripheral to operate the AD4695/AD4696 (see the [SPI Peripheral Connections](#) section).

In conversion mode, the SPI transfers must begin after $t_{CONVERT}$ has elapsed and must complete within t_{SCKCNV} before the next CNV rising edge (see Table 2 and in the timing diagrams in the [Conversion Mode Timing Diagrams](#) section). To ensure that the conversion mode timing requirements are met, the digital host SPI peripheral must either be synchronized to the clock source generating the CNV signal or to the busy indicator output from the AD4695/AD4696. The SCK frequency must also be sufficiently high to ensure that all conversion mode results are clocked out before the start of the next conversion frame (see the [Conversion Mode SPI Clock Frequency Requirements](#) section).

Figure 121 shows a simplified connection diagram and software architecture for operating the AD4695/AD4696 with only a 4-wire SPI. The CNV input is driven by the \overline{CS} output from the digital host SPI peripheral. The configuration in Figure 121 requires the \overline{CS} signal to be periodic with deterministic rising edge timing to

achieve the necessary jitter for the application. Synchronize the SPI frames to a timer peripheral, and the \overline{CS} output must have a well defined duty cycle. Figure 101 shows a SPI timing diagram using the configuration in Figure 121.

Figure 122 shows a simplified connection diagram and software architecture for using the digital host countdown timer peripheral to synchronize the host SPI peripheral to the CNV signal source. The countdown timer is configured to trigger on a CNV rising edge, wait for $t_{CONVERT}$ to elapse, and then trigger an interrupt service routine, which calls the SPI peripheral to perform a transfer. The countdown timer is programmed with an integer value (count), which specifies the number of system clock (SYS_CLK) periods to wait before calling the SPI transfer interrupt routine. It is recommended to implement a delay corresponding to the maximum $t_{CONVERT}$ specification given in Table 2. In practice, most digital hosts exhibit some latency between the interrupt service routine triggers and execution, which increases the delay between the CNV rising edge and the start of the SPI transfer. Refer to the digital host specifications to determine the optimal count value for the given application.

Figure 123 shows a simplified connection diagram and software architecture for utilizing the AD4695/AD4696 busy indicator to synchronize the host SPI peripheral to the ADC conversion timing. The busy indicator must be enabled on the BSY_ALT_GP0 or GP3 pin as described in the [Busy Indicator on General-Purpose Pins](#) section, and the digital host must have a digital input that can be configured as a trigger for interrupt service routines. Route the busy indicator to the interrupt input on the digital host and configure the interrupts to trigger on the busy indicator falling edge. Because the busy indicator falling edge is interpreted as the data ready signal, the digital host is not required to implement any further delays between the busy indicator falling edge and the start of the SPI frame.

The configuration in Figure 123 is recommended when utilizing oversampling, because the busy indicator does not go low until the oversampled result is ready, reducing the number of redundant SPI transfers that otherwise occur without additional logic (see Figure 78).

Figure 124 shows a simplified connection diagram and software architecture for utilizing the AD4695/AD4696 threshold detection alert indicator to synchronize the host SPI peripheral to the ADC conversion timing. The alert indicator must be enabled on the BSY_ALT_GP0 or GP2 pin as described in the [Alert Indicator on General-Purpose Pins](#) section. The configuration in Figure 124 is ideal in autonomous conversion applications, where the SPI is idle while the ADC continuously converts until a user defined out of bounds condition occurs. The alert indicator is updated at the end of the conversion phase of the ADC and can therefore be used as the trigger to start the SPI frame, if the SPI frame can be completed before the start of the next conversion. Typically, the interrupt service routine called by the alert indicator rising edge calls the SPI to read back the conversion result and sends the

APPLICATIONS INFORMATION

register configuration mode command over SDI to put the AD4695/AD4696 into register configuration mode.

On the WLCSP model of the AD4695/AD4696, the busy indicator and alert indicator can be routed to the digital host simultaneously. Figure 125 shows a simplified connection diagram and software architecture for utilizing the busy indicator with the alert indicator. The alert indicator can either feed a separate interrupt service routine, or act as a gate for the busy indicator interrupt service

routine to prevent the SPI from reading from the AD4695/AD4696 until the out of bounds condition is met.

The configurations in Figure 124 and Figure 125 are ideal when operating the AD4695/AD4696 in autcycle mode because it allows the digital host to be completely idle until an out of bounds condition occurs, and guarantees the digital host can remain synchronized to the internal conversion timing (see the SPI Peripheral Synchronization in Autcycle Mode section).

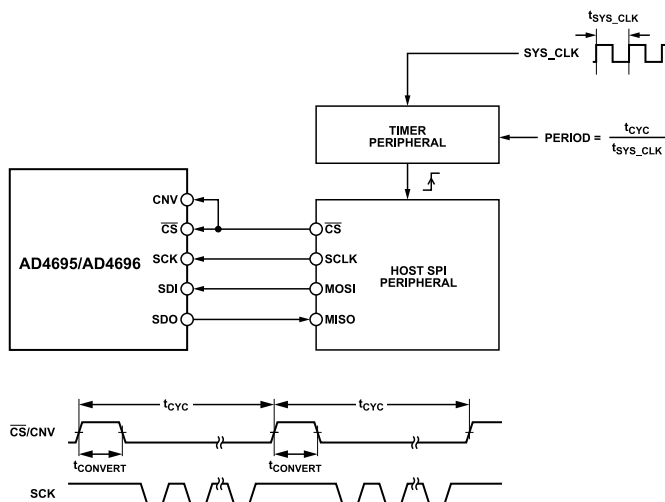

Figure 121. 4-Wire SPI Operation Diagram

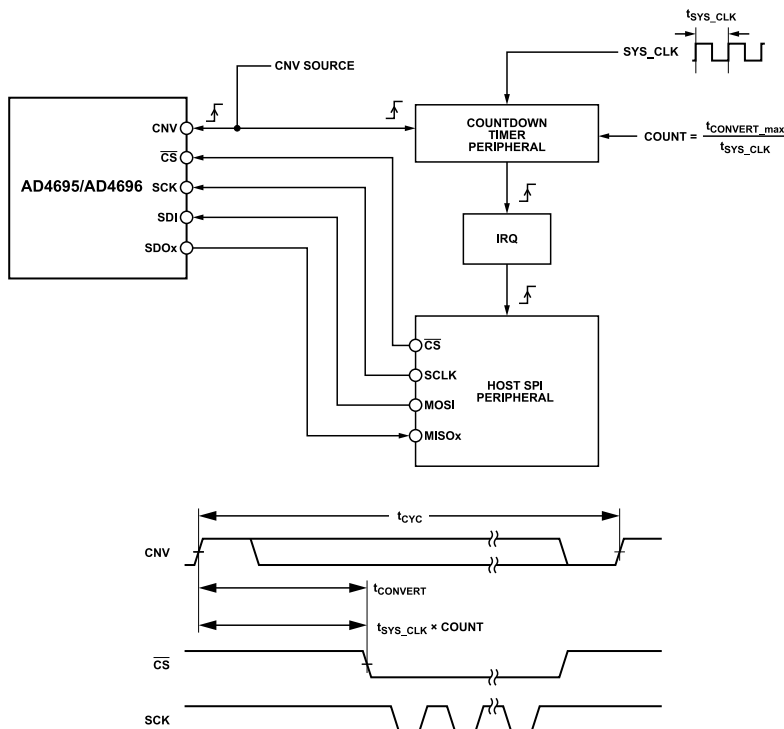

Figure 122. SPI Synchronization with Countdown Timer Peripheral

APPLICATIONS INFORMATION

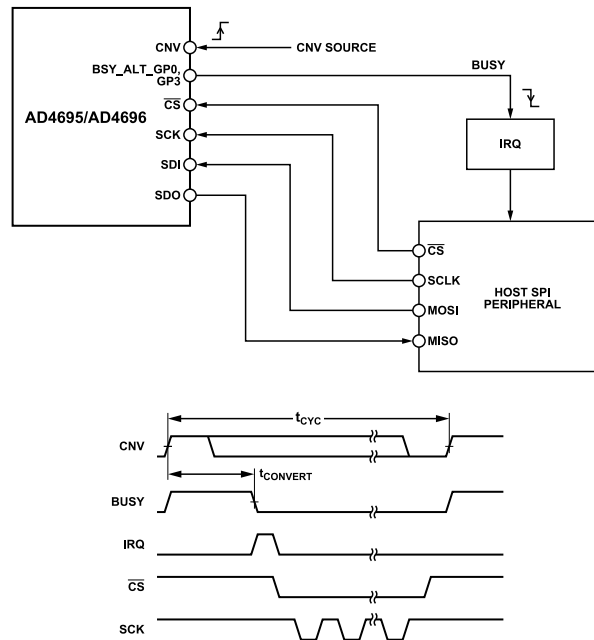

Figure 123. SPI Synchronization with Busy Indicator

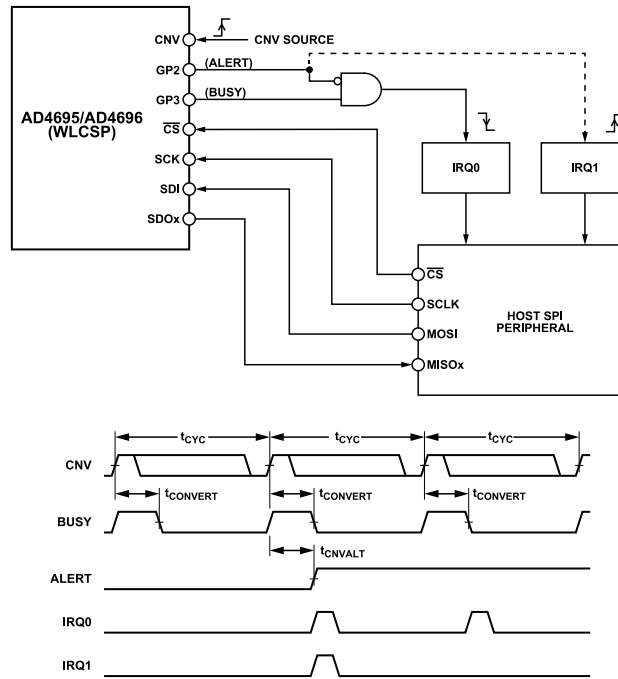

Figure 124. SPI Synchronization with Alert Indicator

APPLICATIONS INFORMATION

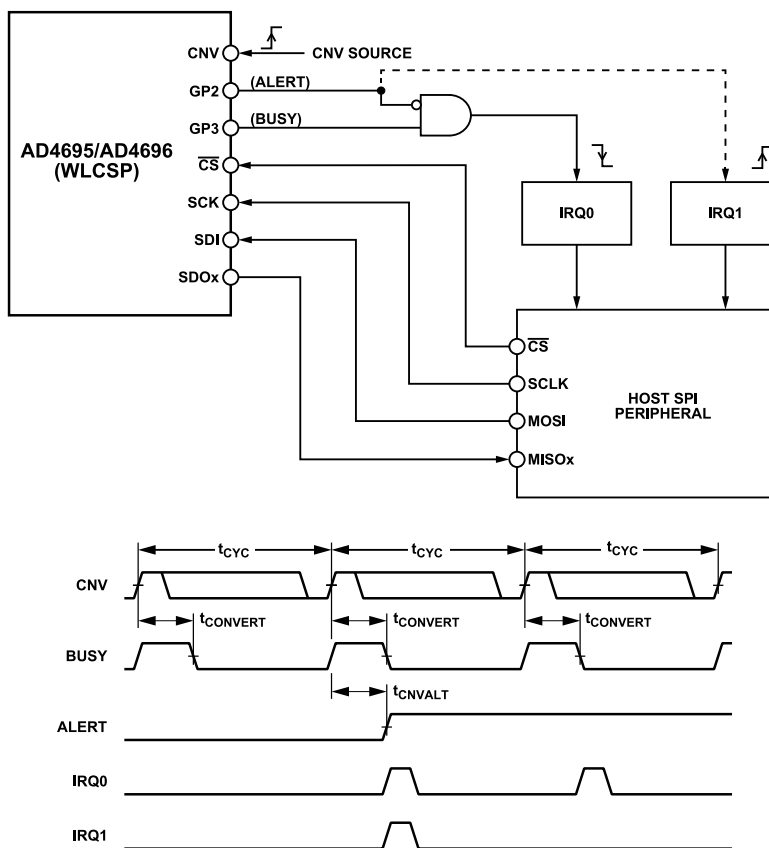

Figure 125. SPI Synchronization with Busy and Alert Indicators

SPI Peripheral Synchronization in Autocycle Mode

If autocycle mode is enabled when the AD4695/AD4696 enter conversion mode, the convert start instructions for the ADC core are generated by an internal oscillator (see the [Autocycle Mode](#) section). Autocycle mode is therefore ideal for autonomous conversion applications, where the digital host is idle or in a sleep state until a user programmed threshold detection event occurs as described in the [Threshold Detection and Alert Indicators](#) section.

The digital host SPI must not attempt to read/write data while the AD4695/AD4696 are still in the conversion phase. In autocycle mode, the convert start signal is generated internally, and the digital host must therefore reference either the busy indicator or the alert indicator via the general-purpose pin(s) to synchronize the AD4695/AD4696 and digital host SPIs and ensure that SPI frames occur between ADC conversion phases. [Figure 103](#) shows the required SPI frame timing relative to the busy indicator and alert indicator when autocycle mode is enabled.

The configurations in [Figure 124](#) and [Figure 125](#) are recommended when utilizing autocycle mode to achieve synchronization between the AD4695/AD4696 internal conversion timing and the host SPI peripheral.

The busy indicator can be used to trigger an interrupt service routine to read the most recent conversion result and send the 5-bit SDI commands (see [Table 18](#)). The busy indicator transitions low at the end of each conversion phase and transitions high at the start of each next conversion phase. The digital host must begin the SPI frame following the busy indicator falling edge, and the SCK rate must be sufficiently fast to complete the SPI frame at least 80 ns prior to the next busy indicator rising edge to conform to the t_{SCKCNV} specification in [Figure 103](#) and [Table 2](#) (see the [Conversion Mode SPI Clock Frequency Requirements](#) section). The time duration between busy indicator falling edge and rising edge is given by the t_{ACBSY} specification in [Table 2](#).

The alert indicator can be used as a one-shot trigger for an interrupt service routine on the digital host to instruct the host SPI peripheral to send the register configuration mode command and poll the alert registers (see [Figure 124](#)). The alert indicator state is updated following the completion of the conversion phase. Therefore, an alert indicator rising edge can signify to the digital host that the AD4695/AD4696 SPI is ready for an SPI frame. The alert indicator only transitions when a threshold violation is detected on a given channel, however, and therefore the digital host is not able to read conversion results except for those that cause the alert indicator to go high (see the [Alert Indicator on General-Purpose Pins](#) section).

APPLICATIONS INFORMATION

On the WLCSP option, the busy indicator and alert indicator can be output simultaneously on multiple general-purpose pins (see [Figure 125](#)). In this configuration, the alert indicator can be used to either gate the busy indicator or act as an enable signal to the host SPI peripheral, while the busy indicator is still used to synchronize SPI reads to the AD4695/AD4696 internal conversion timing.

As described in the [SPI Peripheral Synchronization in Conversion Mode](#) section, the digital host must complete the SPI frame before the start of the next conversion. Refer to [Figure 103](#) and the [Conversion Mode SPI Clock Frequency Requirements](#) section for guidelines on minimum SCK frequency and overall system latency to achieve appropriate SPI transfer rates for the selected sample rate.

Conversion Mode SPI Clock Frequency Requirements

Conversion results for a given sample are available until the start of the next conversion phase. The SCK frequency must therefore be fast enough to read the data from the AD4695/AD4696 SPI before the following CNV rising edge (or internal convert start signal when autcycle mode is enabled).

The minimum required SCK frequency is a function of the sample rate in use, the length of the SPI frame (in bits), and the serial data output mode in use. Faster sample rates require faster SCK frequencies because the time between conversions is shorter. Dual-SDO mode and quad-SDO mode significantly reduces the required SCK frequency for a given sample rate by doubling and quadrupling the number of bits output on the SPI per SCK period, respectively (see the [Serial Data Output Modes](#) section).

The number of SCK periods required per conversion mode frame (N_{SCK}) is a function of the number of bits per frame (N_{BITS}) and the number of serial data outputs (N_{SDO}):

$$N_{SCK} = \frac{N_{BITS}}{N_{SDO}} \quad (21)$$

N_{BITS} depends on the maximum OSR in use and whether the status bits are enabled (see [Table 21](#), [Table 22](#), and [Table 23](#)). N_{SDO} is 1 for single-SDO mode, 2 for dual-SDO mode, and 4 for quad-SDO mode. (Note that quad-SDO mode is only available on the WLCSP option of the AD4695/AD4696.)

The [Conversion Mode Timing Diagrams](#) section shows timing diagrams for the SPI frames in conversion mode. The start of the conversion mode SPI frame must not occur before the $t_{CONVERT}$ time has elapsed and must complete early enough to adhere to the minimum t_{SCKCNV} specification (see [Table 2](#)). The amount of time given to complete an SPI frame in conversion mode (t_{FRAME}) is calculated as follows:

$$t_{FRAME} = t_{CYC} - t_{CONVERT} - t_{SCKCNV} = \frac{1}{f_{CNV}} - t_{CONVERT} - t_{SCKCNV} \quad (22)$$

where:

t_{CYC} is the sample period.

$t_{CONVERT}$ is the maximum $t_{CONVERT}$ specification.

t_{SCKCNV} is the SCK to CNV rising edge delay specification (see [Table 2](#)).

The f_{SCK} is a function of t_{FRAME} and N_{SCK} .

$$f_{SCK} > \frac{N_{SCK}}{t_{FRAME}} = \frac{N_{BITS}}{N_{SDO} \times (t_{CYC} - t_{CONVERT} - t_{SCKCNV})} \quad (23)$$

[Table 28](#) shows examples of the minimum SCK frequency required for several sample rates for each serial data output mode with status bits disabled and enabled and the OSR set to 1.

When single-cycle command mode is enabled, the multiplexer does not update channels until the 5-bit channel command is clocked in on SDI. The SCK frequency therefore impacts t_{ACQ} when single-cycle command mode is enabled (see the [Single-Cycle Command Mode](#) section).

When autcycle mode is enabled, t_{CYC} is determined by the internal convert-start signal, the period of which is set by the AC_CYC field, and the digital host must use either the busy indicator or the alert indicator to synchronize the SPI frames with the internal conversion timing (see the [SPI Peripheral Synchronization in Autcycle Mode](#) section).

The digital host SPI peripheral may provide more SCK periods than required per conversion mode SPI frame. The behavior of SDO when additional SCK falling edges occur after the LSB is clocked out depends on the SDO_STATE bit setting. When SDO_STATE = 0, SDO maintains its state when extra SCK falling edges occur. When SDO_STATE = 1, SDO transitions to high impedance when extra SCK falling edges occur.

Note that the minimum SCK period is longer for register configuration mode than for conversion mode (see t_{SCK} in [Table 2](#)). In conversion mode, the minimum t_{SCK} is 12.5 ns, corresponding to a maximum f_{SCK} of 80 MHz. In register configuration mode, the minimum t_{SCK} is 40 ns, corresponding to a maximum f_{SCK} of 25 MHz. Therefore, for applications requiring conversion mode SCK frequencies of greater than 25 MHz, ensure the host SPI peripheral serial clock rate is programmed accordingly while the AD4695/AD4696 are in register configuration mode.

APPLICATIONS INFORMATION

Table 28. Minimum f_{SCK} Requirements vs. Sample Rate and Serial Data Output Modes (OSR = 1)

Sample Rate (kSPS)	Status Bits ¹	Single-SDO Mode	Dual-SDO Mode	Quad-SDO Mode
1000 (AD4696 Only)	Disabled	32 MHz	16 MHz	8 MHz
1000 (AD4696 Only)	Enabled	48 MHz	24 MHz	12 MHz
500	Disabled	11 MHz	5.5 MHz	2.75 MHz
500	Enabled	16 MHz	8 MHz	4 MHz
100	Disabled	2 MHz	1 MHz	500 kHz
100	Enabled	2.6 MHz	1.3 MHz	650 kHz

¹ In the calculations in Table 28, $N_{BITS} = 16$ when status bits are disabled and $N_{BITS} = 24$ when status bits are enabled.

RESET Connection Recommendations

The \overline{RESET} input allows the digital host to trigger a full device reset with a GPIO (see the [Hardware Reset](#) section). The \overline{RESET} input is active low and must be driven low to initiate a hardware reset. The AD4695/AD4696 remain in the reset state until the \overline{RESET} input is driven high.

Hardware resets are not required to operate the AD4695/AD4696, because the SPI provides a software reset option (see the [Software Reset](#) section). For systems not utilizing hardware reset functionality, tie the \overline{RESET} input to VIO on board to ensure it is pulled high during device operation.

To utilize hardware resets, connect the \overline{RESET} input to a GPIO or equivalent digital output from the digital host. The signal driving \overline{RESET} must idle high. It is recommended to also include a weak pull-up resistor to VIO on the \overline{RESET} input to ensure it is pulled high until the digital host output is in a defined state. The host firmware function for performing hardware resets must pulse \overline{RESET} low following the timing requirements in [Figure 104](#).

DEVICE CONFIGURATION RECOMMENDATIONS

The following are recommendations for configuring the desired AD4695/AD4696 features and settings via the configuration registers described in the [Register Information](#) section.

The AD4695/AD4696 must be in register configuration mode to access the configuration registers via the SPI. The AD4695/AD4696 enter register configuration mode on device power-up and following device resets. The settings in the configuration registers must be properly programmed for the specific application prior to entering conversion mode and performing conversions.

On device power-up, it is recommended to perform either a hardware or software reset as described in the [Device Reset](#) section.

First, program the contents of the SPI_CONFIG_A, SPI_CONFIG_B and SPI_CONFIG_C registers to the desired settings to ensure the AD4695/AD4696 SPI protocol is configured to be compatible with the digital host (see the [Register Configuration Mode](#) section). The scratch pad register (SCRATCH_PAD) allows the digital host to validate communications with the AD4695/AD4696 by

writing test values and reading them back without affecting device settings.

When using the internal reference buffer (WLCSP only), it is recommended to configure the REF_CTRL register contents as soon as possible to give ample time for the output of the internal reference buffer to settle while configuring the remaining registers (as described in the [Optimizing Reference Buffer Startup](#) section). When not using the internal reference buffer, the timing for updating the REF_CTRL register is not important, but the REF_CTRL register must be updated before entering conversion mode if the required reference input high-Z mode enable setting, VREF_SET setting, or overvoltage reduced current mode setting are different from their default settings (see [Table 49](#)).

Next, when powering VDD externally, it is recommended to disable the internal LDO by setting the LDO_EN bit in the setup register to 0 (see the [Internal LDO](#) section). Note that setting the SPI_MODE bit to a 1 puts the AD4695/AD4696 into conversion mode. Ensure that SPI_MODE is set to 0 until the remaining configuration registers are properly configured.

Next, configure the channel sequencing registers for the desired channel sequencing mode. The SEQ_CTRL register contains the STD_SEQ_EN bit and NUM_SLOTS_AS field, which must be configured to select the desired channel sequencing mode. By default, the STD_SEQ_EN bit is set to 1, which selects the standard sequencer (see [Table 50](#)).

If using the standard sequencer, ensure the STD_SEQ_EN bit is set to 1, and then program the STD_SEQ_CONFIG register and TEMP_CTRL register to select the channels for the sequence (see [Table 52](#) and [Table 56](#)).

If using the advanced sequencer, update the SEQ_CTRL register to set the STD_SEQ_EN bit to 0 and set the NUM_SLOTS_AS field to the desired number of advanced sequencer slots, and program the appropriate number of AS_SLOTn registers and TEMP_CTRL register to implement the desired channel sequence (see [Table 56](#) and [Table 63](#)).

If using either two-cycle command mode or single-cycle command mode, update the SEQ_CTRL register to set the STD_SEQ_EN bit to 0 but keep the NUM_SLOTS_AS field set to 0x0. The CYC_CTRL bit must also be set to select between two-cycle and

APPLICATIONS INFORMATION

single-cycle command modes, but because `CYC_CTRL` is in the setup register, it can be configured in the same frame as the `SPI_MODE` bit is set to put the device in conversion mode.

After the channel sequencing mode settings are configured, update the `CONFIG_INn` register settings as needed to select the channel configuration settings, including threshold detection alert enable setting, polarity mode, pin pairing option, analog input high-Z mode enable setting, and `OSR`. When the standard sequencer is enabled, the settings programmed into the `CONFIG_INn` register bits are applied to all analog input channels. When any other channel sequencing mode is selected, the settings in each `CONFIG_INn` register are applied to their corresponding `INn` channel. See [Table 57](#) for a detailed description of the bits in the `CONFIG_INn` registers.

When enabling threshold detection for any set of channels, update the values in the corresponding `UPPER_INn` and `LOWER_INn` registers to implement the desired upper and lower threshold limits (see [Table 58](#) and [Table 59](#)). The `ALERT_MODE` bit must be updated to enable or disable hysteresis, but because `ALERT_MODE` is in the `SETUP` register, it can be configured in the same frame as the `SPI_MODE` bit is set to put the device in conversion mode. If enabling hysteresis, the `HYST_INn` registers must be updated to implement the desired hysteresis settings.

If utilizing any of the general-purpose pin functions described in the [General-Purpose Pins](#) section, update the `GPIO_CTRL` and `GP_MODE` register contents accordingly (see [Table 53](#) and [Table 54](#)).

If using autcycle mode, update the settings in the `AC_CTRL` register to enable autcycle mode and select the desired sample rate (see [Table 51](#)). Autcycle mode is disabled by default. Therefore, if autcycle mode is not being used, it is not necessary to update the `AC_CTRL` register after a device reset.

If utilizing offset and gain correction, update the settings in the `OFFSET_INn` and `GAIN_INn` registers accordingly. If a calibration routine is required to determine the necessary offset and gain correction values for each channel, update the `OFFSET_INn` and `GAIN_INn` registers after putting the AD4695/AD4696 into conversion mode to collect enough conversion data.

After all other necessary configuration register settings have been updated, put the AD4695/AD4696 in conversion mode by setting the `SPI_MODE` bit in the setup register to 1. Ensure that all other bits in the setup register are set to achieve the desired device settings (see [Table 48](#)).

Prior to updating the setup register to put the device in conversion mode, the digital host may optionally check the state of the `SPI_ERROR` bit in the status register to verify that there were no errors in updating the configuration registers. The host can also check the state of the `CLAMP_STATUS1` and `CLAMP_STATUS2` registers to check if any of the AD4695/AD4696 analog input

channels are experiencing overvoltage events prior to putting the device into conversion mode.

While the AD4695/AD4696 are in conversion mode, the SPI cannot be used to update the configuration registers. If any of the configuration registers need to be read from or updated while the device is already in conversion mode, send the register configuration mode command during a conversion mode SPI frame to put the device back into register configuration mode (see the [Register Configuration Mode Command](#) section).

EFFECTIVE CHANNEL SAMPLE RATE

The AD4695/AD4696 analog inputs are multiplexed to a single ADC core, and the state of the multiplexer is updated at the end of the conversion phase. The effective sample rate for each channel in the channel sequence is therefore some fraction of the sample rate of the ADC, which is set by f_{CNV} . The effective sample rate for a channel is defined as the frequency at which each new conversion result is generated for that channel.

For an analog input to have an effective sample rate, new results must be generated at a constant rate for the entire channel sequence or at least for a long enough time span to perform the necessary analysis. For example, to calculate an FFT and perform ac analysis on the ADC data for a given channel, the sampling interval between each sample gathered for that channel must be constant. The effective sample rate for an analog input (f_{S_INx}) is a function of f_{CNV} and the number of `CNV` periods between each time it is sampled (N_{CNV}). The following relationship applies for each of the 16 analog inputs (`IN0` to `IN15`) and for the temperature sensor as follows:

$$f_{S_INx} = \frac{f_{CNV}}{N_{CNV}} \quad (24)$$

The required f_{S_INx} for each analog input is determined by its input signal frequency range. The Nyquist frequency for a given analog input (which is half of f_{S_INx}) must be greater than the highest signal frequency being measured to avoid aliasing.

When the standard sequencer is enabled, each enabled channel in the `STD_SEQ_CONFIG` register is sampled once per sequence iteration. f_{S_INx} is therefore always constant for each enabled channel when the standard sequencer is enabled, and is calculated as follows:

$$f_{S_INx} = \frac{f_{CNV}}{(N_{EN} \times OSR)} \quad (25)$$

where:

N_{EN} is the number of inputs included in the channel sequence and can range from 1 (only one channel enabled) to 17 (when all channels and the temperature sensor are enabled).

`OSR` is the oversampling ratio selected by the `OSR_SET` field in the `CONFIG_IN0` register.

APPLICATIONS INFORMATION

In the example provided in [Figure 76](#), with $N_{EN} = 4$ and $OSR = 1$, f_{S_INx} is $f_{CNV}/4$. If the OSR is programmed to 4 in this example, f_{S_INx} is $f_{CNV}/16$.

When the advanced sequencer two-cycle command mode or single-cycle command mode is enabled, the sequence of analog input channels is more flexible, and the channel sequence can be designed to implement multiple effective sample rates. This design option is useful in applications with a combination of channels with low frequency or dc signals and channels with high frequency or ac signals. The [Implementing Two Effective Channel Sample Rates](#) section describes how to design a channel sequence that achieves two effective sample rates for two sets of channels.

[Table 29](#) and [Figure 126](#) shows an example of a sequence that achieves three effective sample rates with four analog inputs. The sequence in [Table 29](#) and [Figure 126](#) can be implemented with the advanced sequencer and two-cycle command mode, or single-cycle command mode.

The advanced sequencer, two-cycle command mode, and single-cycle command mode can also be utilized to perform aperiodic conversions on analog inputs, for example, when all channels have dc-type signals, or when the channel sequencing involves adaptive control logic.

Table 29. Multiple Effective Sample Rates Example

Sequence Position	Input	Effective Sample Rate of Input
0	IN0	$f_{CNV}/2$
1	IN1	$f_{CNV}/4$
2	IN0	$f_{CNV}/2$
3	IN2	$f_{CNV}/8$
4	IN0	$f_{CNV}/2$
5	IN1	$f_{CNV}/4$
6	IN0	$f_{CNV}/2$
7	IN3	$f_{CNV}/8$

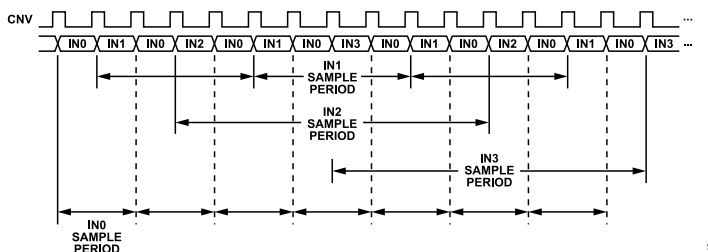

Figure 126. Multiple Effective Sample Rates Example

APPLICATIONS INFORMATION

Implementing Two Effective Channel Sample Rates

In multichannel data acquisition systems, the ADC may be monitoring a mix of higher frequency and lower frequency or dc type signals. Channels with higher maximum input frequencies require higher Nyquist frequencies, and therefore require higher effective sample rates than channels with lower maximum input frequencies. To maximize the effective sample rate for analog input channels with higher frequency input signals, the channel sequence can be designed to implement two different effective sample rates.

In a custom channel sequence that implements two effective sample rates, each of the AD4695/AD4696 channels included in the sequence are categorized as either high sample rate (HSR) channels or low sample rate (LSR) channels. Figure 127 shows a generalized channel sequence implementing HSR and LSR channels.

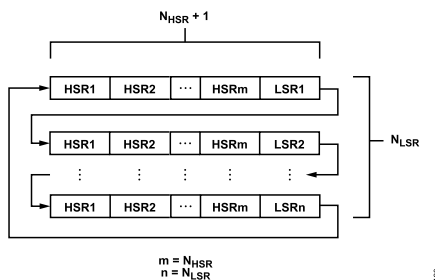

Figure 127. Sequence of HSR and LSR Inputs with Two Effective Sample Rates

The full channel sequence in Figure 127 consists of a repeating sub sequence of all HSR channels, followed by one LSR channel. The sub sequences repeat until all LSR channels are sampled once, and then the entire sequence starts again. As a result, the LSR channels are sampled only once per sequence iteration, whereas the HSR channels are sampled once for each LSR channel in the sequence.

The number of HSR channels (N_{HSR}) and the number of LSR channels (N_{LSR}) dictate their effective sample rates, as well as the number of sequence positions required to implement the two sample rates. The number of sequence positions required (N_S) follows the relation:

$$N_S = N_{LSR} \times (N_{HSR} + 1) \quad (26)$$

where:

N_{HSR} is the number of HSR inputs.

N_{LSR} is the number of LSR inputs.

When the advanced sequencer is enabled, the maximum value of N_S is limited by the number of AS_SLOTn registers. When two-cycle command mode or single-cycle command mode is enabled, N_S can be arbitrarily large.

Because the LSR channels are only sampled once per full sequence iteration, their effective sample rate (f_{S_LSR}) is the sample rate of the ADC core (set by f_{CNV}) divided by N_S as follows:

$$f_{S_LSR} = \frac{f_{CNV}}{N_S} \quad (27)$$

Because the HSR inputs are sampled once for each LSR input in the sequence, the effective sample rate for the HSR inputs (f_{S_HSR}) is as follows:

$$f_{S_HSR} = \frac{f_{CNV} \times N_{LSR}}{N_S} \quad (28)$$

Table 30 shows an example where IN5, IN9, and IN14 are HSR channels and IN2, IN10, and the temperature sensor are LSR channels.

Table 30. Sequence with Two Effective Channel Sample Rates

Sequence Position	Input	Effective Sample Rate of Input
0	IN5	$f_{CNV}/4$
1	IN9	$f_{CNV}/4$
2	IN14	$f_{CNV}/4$
3	IN2	$f_{CNV}/12$
4	IN5	$f_{CNV}/4$
5	IN9	$f_{CNV}/4$
6	IN14	$f_{CNV}/4$
7	IN10	$f_{CNV}/12$
8	IN5	$f_{CNV}/4$
9	IN9	$f_{CNV}/4$
10	IN14	$f_{CNV}/4$
11	Temperature sensor	$f_{CNV}/12$

Note that implementing the sequence in Table 30 with the advanced sequencer requires the following register configuration settings:

- ▶ STD_SEQ_EN = 0
- ▶ NUM_SLOTS_AS = 10
- ▶ TEMP_EN = 1

The first 11 advanced sequencer slots (AS_SLOT0 to AS_SLOT10) are also programmed with the analog inputs listed in Table 30, because the temperature sensor is enabled via the TEMP_EN bit instead of via the advanced sequencer slots.

Note that when using the advanced sequencer, the temperature sensor cannot be assigned as an HSR channel because it cannot be assigned with the AS_SLOTn registers. However, the temperature sensor can be included as an LSR channel by enabling it via the TEMP_EN bit in the TEMP_CTRL register, as demonstrated in Table 30.

LAYOUT GUIDELINES

The following are suggested layout techniques for achieving optimal performance of the AD4695/AD4696 populated on a printed circuit board (PCB). An example PCB layout with the AD4696

APPLICATIONS INFORMATION

is provided in the user guide for the AD4696 evaluation board ([EVAL-AD4696FMCZ](#)).

Analog traces (that is, traces connected to the analog inputs and reference input) must be physically separated from the digital traces (that is, traces to the CNV input, SPI, and general-purpose pins) to limit cross coupling from fast switching digital signals into the analog input signals. Add ground fill between analog and digital traces on the same PCB layer. Do not cross digital traces over the analog traces or the AD4695/AD4696 device without a ground plane PCB layer in between. The analog and digital pins on the AD4695/AD4696 are arranged to facilitate separation of analog and digital traces.

The AD4695/AD4696 analog inputs (IN0 to IN15) have a dynamic input impedance due to the multiplexer and ADC core input switches, which toggle between conversions. An external capacitor is recommended to reduce nonlinear voltage steps at the analog inputs. Place these external capacitors as close to the analog inputs as possible to minimize parasitic impedances between the two, which can degrade performance. See the [Analog Front-End Design](#) section for more information.

The AD4695/AD4696 voltage reference input, REF, also has a dynamic input impedance. The effective impedance between the reference drive circuitry output and the REF input must be very low, and a decoupling capacitor must be placed as close to the REF pin as possible. If the internal reference buffer is not used, connect the external reference circuitry to the REF pin with wide traces to minimize the trace impedance (see the [Reference Circuitry Design](#) section).

The power supplies of the AD4695/AD4696 must be decoupled with low ESR ceramic capacitors placed close to the supply pins, and connected using short, wide traces to provide low impedance paths and to reduce the effect of glitches on the power supply lines (see the [Power Supplies](#) section). If LDO_IN is powered from the same supply as AVDD, Short the pins with a wide common trace, and a single 100 nF capacitor can be used to decouple both pins.

The [AN-617 Application Note](#), *Wafer Level Chip Scale Package*, has information on PCB layout and assembly for the WLCSP.

EVALUATING AD4695/AD4696 PERFORMANCE

The AD4695/AD4696 evaluation tool offerings include a fully assembled and tested evaluation board including the AD4696 ([EVAL-AD4696FMCZ](#)), evaluation software for controlling the board from a PC, and support documentation for the hardware and software. The evaluation software requires the EVAL-SDP-CH1Z controller board to establish communication between the PC and the [EVAL-AD4696FMCZ](#) board.

The [EVAL-AD4696FMCZ](#) board allows for prototyping the analog front-end circuitry and reference circuitry with the various digital features offered by the AD4696. It also features a standard 160-pin field-programmable gate array (FPGA) mezzanine card (FMC) connector and 12-pin extended SPI peripheral module (PMOD)

connector which allow for prototyping communication between the on-board AD4696 and many third party FPGA development boards.

REGISTER INFORMATION

REGISTER OVERVIEW

The AD4695/AD4696 have programmable configuration registers that contain the bits and fields used to monitor device status and configure the device. Reading or writing to these bits and fields requires reading or writing to the registers that contain them. The AD4695/AD4696 SPI is used to read and write to the configuration registers (see the [Register Configuration Mode](#) section).

The AD4695/AD4696 register map memory space is divided into bytes. Each byte of memory has a unique address, ranging from 0x0000 to 0x017F. [Table 31](#) shows the register memory address assignments for all of the AD4695/AD4696 configuration registers.

Each configuration register is a single byte or multiple bytes in length. Registers that are multiple bytes long are called multibyte registers. The address of each multibyte register is defined as the address of its least significant byte, but each byte in a multibyte register has a unique address in the register map memory space. For example, the STD_SEQ_CONFIG register is two bytes long, and its least significant byte (LSByte) address is 0x0024 and its most significant byte (MSByte) address is 0x0025. The state of the MB_STRICT bit in the SPI_CONFIG_C register determines whether all bytes in a multibyte register must be read or written in a single

SPI transaction, or if each individual byte must be read or written in separate SPI transactions (see the [Multibyte Register Access](#) section).

Bits and fields in the AD4695/AD4696 configuration registers are defined as read only, read/write or R/W1C. Read only bits can only be read from and cannot be updated by SPI writes from the host SPI. Read/write bits can be read from or written to. Write 1 to clear bits can be read from and are only reset to 0 when the digital host writes a 1 in their memory location.

In the access column of [Table 31](#), registers that contain exclusively read-only bits are represented with R and registers with writeable bits are represented with R/W. In the access column of [Table 32](#) through [Table 63](#), read only bits are represented with R, read/write bits are represented with R/W, and write 1 to clear bits are represented with R/W1C.

The SPI_STATUS register contains various error flags that indicate whether a SPI read or write transaction violated one of several aspects of the protocols outlined in the [Register Configuration Mode](#) section (see [Table 40](#)). The SPI_ERROR bit in the status register is the bitwise logical OR of the error flags in the SPI_STATUS register (see [Table 41](#)).

Table 31. Configuration Register Names and Descriptions

Address	Name	Description	Length	Reset	Access
0x0000	SPI_CONFIG_A	Interface Configuration A.	Single byte	0x10	R/W
0x0001	SPI_CONFIG_B	Interface Configuration B.	Single byte	0x00	R/W
0x0003	DEVICE_TYPE	Device type.	Single byte	0x07	R
0x000A	SCRATCH_PAD	Scratch pad.	Single byte	0x00	R/W
0x000C	VENDOR_L	Vendor ID (lower byte).	Single byte	0x56	R
0x000D	VENDOR_H	Vendor ID (upper byte).	Single byte	0x04	R
0x000E	LOOP_MODE	Loop mode.	Single byte	0x00	R/W
0x0010	SPI_CONFIG_C	Interface Configuration C.	Single byte	0x23	R/W
0x0011	SPI_STATUS	Interface status.	Single byte	0x00	R/W
0x0014	STATUS	Device status.	Single byte	0x20	R
0x0015	ALERT_STATUS1	Alert status (IN0 to IN3).	Single byte	0x00	R
0x0016	ALERT_STATUS2	Alert status (IN4 to IN7).	Single byte	0x00	R
0x0017	ALERT_STATUS3	Alert status (IN8 to IN11).	Single byte	0x00	R
0x0018	ALERT_STATUS4	Alert status (IN12 to IN15).	Single byte	0x00	R
0x001A	CLAMP_STATUS1	Clamp status (IN0 to IN7).	Single byte	0x00	R
0x001B	CLAMP_STATUS2	Clamp status (IN8 to IN15).	Single byte	0x00	R
0x0020	SETUP	Device setup.	Single byte	0x10	R/W
0x0021	REF_CTRL	Reference control.	Single byte	0x12	R/W
0x0022	SEQ_CTRL	Sequencer control.	Single byte	0x80	R/W
0x0023	AC_CTRL	Autocycle control.	Single byte	0x00	R/W
0x0024	STD_SEQ_CONFIG	Standard sequencer configuration.	Multibyte	0x0001	R/W
0x0026	GPIO_CTRL	GPIO enable.	Single byte	0x00	R/W
0x0027	GP_MODE	General-purpose pin function control.	Single byte	0x00	R/W
0x0028	GPIO_STATE	GPIO state.	Single byte	0x00	R/W
0x0029	TEMP_CTRL	Temperature sensor control.	Single byte	0x00	R/W
0x0030 to 0x003F	CONFIG_INn	Analog input settings configuration.	Single byte	0x08	R/W
0x0040 to 0x005E	UPPER_INn	Upper threshold value.	Multibyte	0x07FF	R/W

REGISTER INFORMATION

Table 31. Configuration Register Names and Descriptions

Address	Name	Description	Length	Reset	Access
0x0060 to 0x007E	LOWER_INn	Lower threshold value.	Multibyte	0x0000	R/W
0x0080 to 0x009E	HYST_INn	Hysteresis setting.	Multibyte	0x0010	R/W
0x00A0 to 0x00BE	OFFSET_INn	INn offset correction.	Multibyte	0x0000	R/W
0x00C0 to 0x00DE	GAIN_INn	INn gain correction.	Multibyte	0x8000	R/W
0x0100 to 0x017F	AS_SLOTn	Advanced sequencer slot.	Single byte	0x00	R/W

REGISTER DETAILS

SPI Configuration A Register

Address: 0x0000, Reset: 0x10, Name: SPI_CONFIG_A

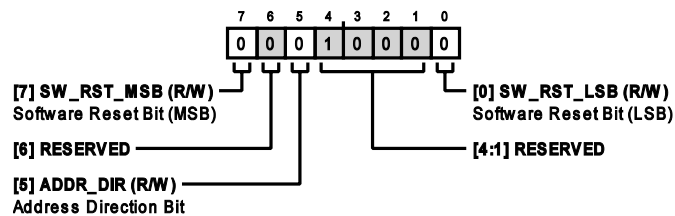

Table 32. Bit Descriptions for SPI_CONFIG_A

Bits	Bit Name	Description	Reset	Access
7	SW_RST_MSB	Software Reset Bit (MSB). Setting both the SW_RST_MSB bit and SW_RST_LSB bit to 1 initiates a software reset of the device, which resets all registers except the INTERFACE_CONFIG_A register to the default power-up state (see the Software Reset section).	0x0	R/W
6	RESERVED	Reserved.	0x0	R
5	ADDR_DIR	Address Direction Bit. This bit determines sequential addressing behavior when performing register reads and writes on multiple bytes of data in a single data phase (see the Address Direction Options section). 0: select descending address option. 1: select ascending address option.	0x0	R/W
[4:1]	RESERVED	Reserved.	0x8	R
0	SW_RST_LSB	Software Reset Bit (LSB). Setting both the SW_RST_MSB and SW_RST_LSB bits to 1 initiates a software reset of the device, which resets all registers except the INTERFACE_CONFIG_A register to the default power-up state (see the Software Reset section).	0x0	R/W

SPI Configuration B Register

Address: 0x0001, Reset: 0x00, Name: SPI_CONFIG_B

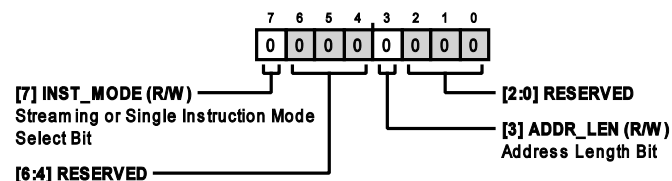

Table 33. Bit Descriptions for SPI_CONFIG_B

Bits	Bit Name	Description	Reset	Access
7	INST_MODE	Streaming or Single Instruction Mode Select Bit. This bit selects between streaming mode and single instruction mode (see the Streaming Mode section and the Single Instruction Mode section). 0: enable streaming mode.	0x0	R/W

REGISTER INFORMATION

Table 33. Bit Descriptions for SPI_CONFIG_B

Bits	Bit Name	Description	Reset	Access
		1: enable single instruction mode.		
[6:4]	RESERVED	Reserved.	0x0	R
3	ADDR_LEN	Address Length Bit. This bit sets the length of the register address in the instruction phase to 7 bits or 15 bits (see the Instruction Phase section). 0: 15-bit addressing. 1: 7-bit addressing.	0x0	R/W
[2:0]	RESERVED	Reserved.	0x0	R

Device Type Register

Address: 0x0003, Reset: 0x07, Name: DEVICE_TYPE

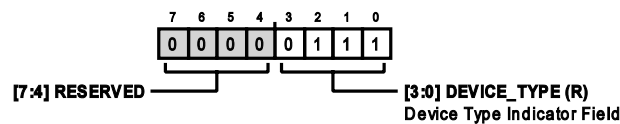

Table 34. Bit Descriptions for DEVICE_TYPE

Bits	Bit Name	Description	Reset	Access
[7:4]	RESERVED	Reserved.	0x0	R
[3:0]	DEVICE_TYPE	Device Type Indicator Field. This field identifies the Analog Devices, Inc., product category that the device belongs to. The value 0x7 corresponds to precision ADCs.	0x7	R

Scratch Pad Register

Address: 0x000A, Reset: 0x00, Name: SCRATCH_PAD

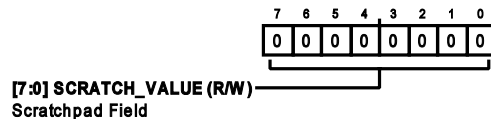

Table 35. Bit Descriptions for SCRATCH_PAD

Bits	Bit Name	Description	Reset	Access
[7:0]	SCRATCH_VALUE	Scratchpad Field. Values written to this register have no impact on the device behavior. Use this register to test SPI communications with the device.	0x00	R/W

Vendor ID (Lower Byte) Register

Address: 0x000C, Reset: 0x56, Name: VENDOR_L

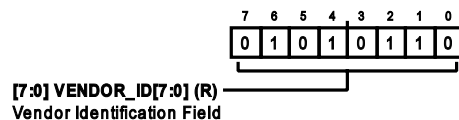

Table 36. Bit Descriptions for VENDOR_L

Bits	Bit Name	Description	Reset	Access
[7:0]	VENDOR_ID[7:0]	Vendor Identification Field. The VENDOR_ID[15:0] field is the same value (0x0456) for all Analog Devices precision ADCs.	0x56	R

REGISTER INFORMATION

Vendor ID (Upper Byte) Register

Address: 0x000D, Reset: 0x04, Name: VENDOR_H

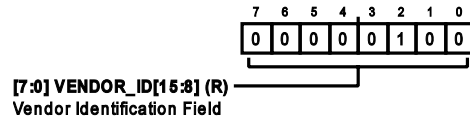

Table 37. Bit Descriptions for VENDOR_H

Bits	Bit Name	Description	Reset	Access
[7:0]	VENDOR_ID[15:8]	Vendor Identification Field. The VENDOR_ID[15:0] field is the same value (0x0456) for all Analog Devices precision ADCs.	0x04	R

Loop Mode Register

Address: 0x000E, Reset: 0x00, Name: LOOP_MODE

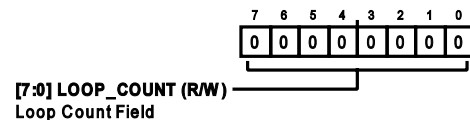

Table 38. Bit Descriptions for LOOP_MODE

Bits	Bit Name	Description	Reset	Access
[7:0]	LOOP_COUNT	Loop Count Field. This field specifies the number of registers to loop through for each SPI frame when streaming mode is selected (see the Streaming Mode section). A value of 0x00 disables looping. Values between 0x01 and 0xFF set the number of registers to loop through before returning to the original register address.	0x00	R/W

SPI Configuration C Register

Address: 0x0010, Reset: 0x23, Name: SPI_CONFIG_C

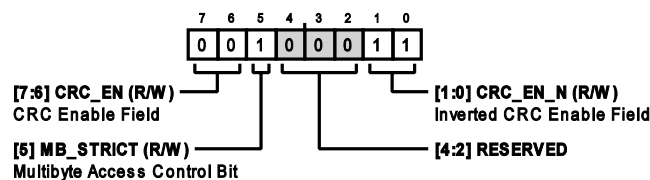

Table 39. Bit Descriptions for SPI_CONFIG_C

Bits	Bit Name	Description	Reset	Access
[7:6]	CRC_EN	CRC Enable Field. This field enables the CRC when set to 0x1 (if CRC_EN_N is also set to 0x2). This field disables the CRC when set to a value other than 0x1 (see the Checksum Protection section). 0: disables CRC. 1: enables CRC if CRC_EN_N = 0x2.	0x0	R/W
5	MB_STRICT	Multibyte Access Control Bit. This bit sets the SPI transaction requirements for multibyte registers (see the Multibyte Register Access section). 0: individual bytes in multibyte registers are read from or written to in individual data phases. 1: all bytes in multibyte registers are read from or written to in a single data phase.	0x1	R/W
[4:2]	RESERVED	Reserved.	0x0	R

REGISTER INFORMATION

Table 39. Bit Descriptions for SPI_CONFIG_C

Bits	Bit Name	Description	Reset	Access
[1:0]	CRC_EN_N	Inverted CRC Enable Field. This field enables the CRC when set to 0x2 (if CRC_EN is also set to 0x1). This field disables the CRC when set to a value other than 0x2 (see the Checksum Protection section).	0x3	R/W

Interface Status Register

Address: 0x0011, Reset: 0x00, Name: SPI_STATUS

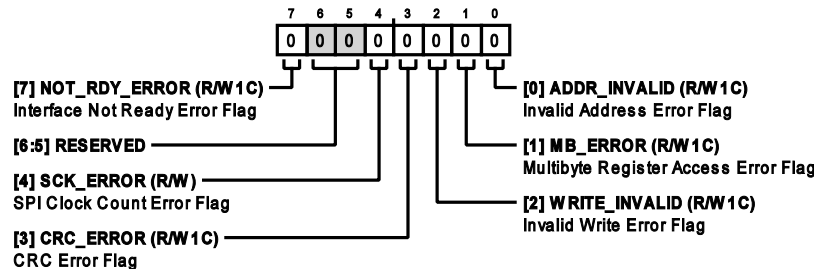

Table 40. Bit Descriptions for SPI_STATUS

Bits	Bit Name	Description	Reset	Access
7	NOT_RDY_ERROR	Interface Not Ready Error Flag. This bit is set to 1 when the digital host initiates an SPI transaction before the AD4695/AD4696 interface is ready to respond, for example, before a device reset is complete.	0x0	R/W1C
[6:5]	RESERVED	Reserved.	0x0	R
4	SCK_ERROR	SPI Clock Count Error Flag. This bit is set to 1 when an incorrect number of serial clock edges is received in an SPI read or write transaction, for example, if the SPI frame ends in the middle of a data phase.	0x0	R/W
3	CRC_ERROR	CRC Error Flag. This bit is set to 1 when the AD4695/AD4696 receives a checksum that does not match its expected value (see the Checksum Protection section). This error flag is only active when the CRC is enabled.	0x0	R/W1C
2	WRITE_INVALID	Invalid Write Error Flag. This bit is set to 1 when the digital host attempts an SPI write to a register that contains exclusively read only bits.	0x0	R/W1C
1	MB_ERROR	Multibyte Register Access Error Flag. This bit is set to 1 when an SPI transaction does not access all bytes of a multibyte register. This error flag is only active when the MB_STRICT bit is set to 1.	0x0	R/W1C
0	ADDR_INVALID	Invalid Address Error Flag. This bit is set to 1 when an SPI transaction attempts to access a nonexistent register (a register with an address outside of the specified range of values in Table 31).	0x0	R/W1C

Device Status Register

Address: 0x0014, Reset: 0x20, Name: STATUS

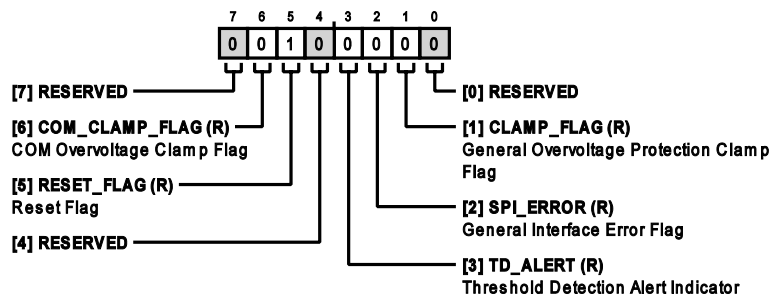

Table 41. Bit Descriptions for STATUS

Bits	Bit Name	Description	Reset	Access
7	RESERVED	Reserved.	0x0	R

REGISTER INFORMATION

Table 41. Bit Descriptions for STATUS

Bits	Bit Name	Description	Reset	Access
6	COM_CLAMP_FLAG	COM Overvoltage Clamp Flag. This bit indicates if the COM overvoltage protection clamp is active because of an overvoltage event. This bit is not sticky and is cleared when the COM overvoltage protection clamp is inactive. 0: COM overvoltage protection clamp inactive. 1: COM overvoltage protection clamp active.	0x0	R
5	RESET_FLAG	Reset Flag. This bit indicates whether a hardware reset or software reset occurred since the last time this bit was read (see the Device Reset section). This bit is automatically cleared when read. 0: no device reset occurred since this bit was last read. 1: a device reset occurred since this bit was last read.	0x1	R
4	RESERVED	Reserved.	0x0	R
3	TD_ALERT	Threshold Detection Alert Indicator. This bit indicates if any combination of the upper or lower alert indicators for IN0 to IN15 is asserted. This bit is the logical OR of all HI_INn and LO_INn bits in the ALERT_STATUS1 register to the ALERT_STATUS4 register. This bit is not sticky. 0: no upper or lower alert indicators asserted. 1: at least one upper or lower alert indicator asserted.	0x0	R
2	SPI_ERROR	General Interface Error Flag. This bit indicates if any of the error flags in the SPI_STATUS register are asserted. This bit is the bitwise logical OR of all bits in the SPI_STATUS register. 0: no interface error detected. 1: one or more interface errors detected.	0x0	R
1	CLAMP_FLAG	General Overvoltage Protection Clamp Flag. This bit indicates if any IN0 to IN15 overvoltage protection clamps were activated by an overvoltage event (if any of the INX_CLAMP_FLAG bits are asserted). This bit is sticky and is only cleared if all INX_CLAMP_FLAG bits are deasserted when the bit is read. 0: all IN0 to IN15 overvoltage clamps are inactive. 1: at least one IN0 to IN15 overvoltage clamps are active.	0x0	R
0	RESERVED	Reserved.	0x0	R

Alert Status (IN0 to IN3) Register

Address: 0x0015, Reset: 0x00, Name: ALERT_STATUS1

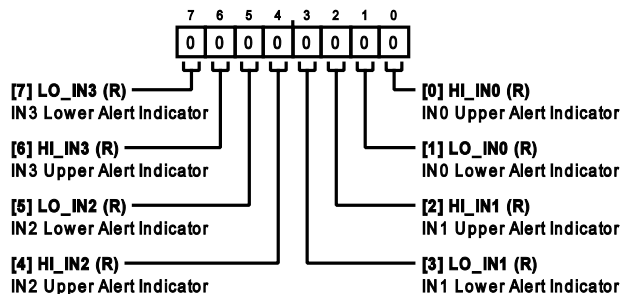

Table 42. Bit Descriptions for ALERT_STATUS1

Bits	Bit Name	Description	Reset	Access
7	LO_IN3	IN3 Lower Alert Indicator. This bit is set to 1 when a conversion result for IN3 is less than or equal to the IN3 lower threshold value. This indicator is only active if the threshold detection is enabled on IN3 (see the Threshold Detection and Alert Indicators section). This bit is read to clear. When the ALERT_MODE bit in the setup register is set to 1, this bit also automatically clears if a subsequent IN3 conversion is within the range set by the HYSTERESIS field in the HYST_IN3 register (see the Alert Indicator Registers section).	0x0	R
6	HI_IN3	IN3 Upper Alert Indicator. This bit is set to 1 when a conversion result for IN3 is greater than or equal to the IN3 upper threshold value. This indicator is only active if the threshold detection is enabled on IN3 (see the Threshold Detection and Alert Indicators section). This bit is read to clear. When the ALERT_MODE bit in the setup register is set to 1, this bit also	0x0	R

REGISTER INFORMATION

Table 42. Bit Descriptions for ALERT_STATUS1

Bits	Bit Name	Description	Reset	Access
		automatically clears if a subsequent IN3 conversion is within the range set by the HYSTERESIS field in the HYST_IN3 register (see the Alert Indicator Registers section).		
5	LO_IN2	IN2 Lower Alert Indicator. This bit is set to 1 when a conversion result for IN2 is less than or equal to the IN2 lower threshold value. This indicator is only active if the threshold detection is enabled on IN2 (see the Threshold Detection and Alert Indicators section). This bit is read to clear. When the ALERT_MODE bit in the setup register is set to 1, this bit also automatically clears if a subsequent IN2 conversion is within the range set by the HYSTERESIS field in the HYST_IN2 register (see the Alert Indicator Registers section).	0x0	R
4	HI_IN2	IN2 Upper Alert Indicator. This bit is set to 1 when a conversion result for IN2 is greater than or equal to the IN2 upper threshold value. This indicator is only active if the threshold detection is enabled on IN2 (see the Threshold Detection and Alert Indicators section). This bit is read to clear. When the ALERT_MODE bit in the setup register is set to 1, this bit also automatically clears if a subsequent IN2 conversion is within the range set by the HYSTERESIS field in the HYST_IN2 register (see the Alert Indicator Registers section).	0x0	R
3	LO_IN1	IN1 Lower Alert Indicator. This bit is set to 1 when a conversion result for IN1 is less than or equal to the IN1 lower threshold value. This indicator is only active if the threshold detection is enabled on IN1 (see the Threshold Detection and Alert Indicators section). This bit is read to clear. When the ALERT_MODE bit in the setup register is set to 1, this bit also automatically clears if a subsequent IN1 conversion is within the range set by the HYSTERESIS field in the HYST_IN1 register (see the Alert Indicator Registers section).	0x0	R
2	HI_IN1	IN1 Upper Alert Indicator. This bit is set to 1 when a conversion result for IN1 is greater than or equal to the IN1 upper threshold value. This indicator is only active if the threshold detection is enabled on IN1 (see the Threshold Detection and Alert Indicators section). This bit is read to clear. When the ALERT_MODE bit in the setup register is set to 1, this bit also automatically clears if a subsequent IN1 conversion is within the range set by the HYSTERESIS field in the HYST_IN1 register (see the Alert Indicator Registers section).	0x0	R
1	LO_IN0	IN0 Lower Alert Indicator. This bit is set to 1 when a conversion result for IN0 is less than or equal to the IN0 lower threshold value. This indicator is only active if the threshold detection is enabled on IN0 (see the Threshold Detection and Alert Indicators section). This bit is read to clear. When the ALERT_MODE bit in the setup register is set to 1, this bit also automatically clears if a subsequent IN0 conversion is within the range set by the HYSTERESIS field in the HYST_IN0 register (see the Alert Indicator Registers section).	0x0	R
0	HI_IN0	IN0 Upper Alert Indicator. This bit is set to 1 when a conversion result for IN0 is greater than or equal to the IN0 upper threshold value. This indicator is only active if the threshold detection is enabled on IN0 (see the Threshold Detection and Alert Indicators section). This bit is read to clear. When the ALERT_MODE bit in the setup register is set to 1, this bit also automatically clears if a subsequent IN0 conversion is within the range set by the HYSTERESIS field in the HYST_IN0 register (see the Alert Indicator Registers section).	0x0	R

Alert Status (IN4 to IN7) Register

Address: 0x0016, Reset: 0x00, Name: ALERT_STATUS2

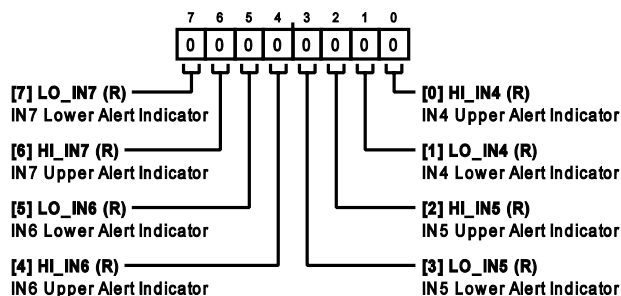

Table 43. Bit Descriptions for ALERT_STATUS2

Bits	Bit Name	Description	Reset	Access
7	LO_IN7	IN7 Lower Alert Indicator. This bit is set to 1 when a conversion result for IN7 is less than or equal to the IN7 lower threshold value. This indicator is only active if the threshold detection is enabled on IN7 (see the Threshold Detection and Alert Indicators section). This bit is read to clear. When the ALERT_MODE bit in the setup register is set to 1, this bit also	0x0	R

REGISTER INFORMATION

Table 43. Bit Descriptions for ALERT_STATUS2

Bits	Bit Name	Description	Reset	Access
		automatically clears if a subsequent IN7 conversion is within the range set by the HYSTERESIS field in the HYST_IN7 register (see the Alert Indicator Registers section).		
6	HI_IN7	IN7 Upper Alert Indicator. This bit is set to 1 when a conversion result for IN7 is greater than or equal to the IN7 upper threshold value. This indicator is only active if the threshold detection is enabled on IN7 (see the Threshold Detection and Alert Indicators section). This bit is read to clear. When the ALERT_MODE bit in the setup register is set to 1, this bit also automatically clears if a subsequent IN7 conversion is within the range set by the HYSTERESIS field in the HYST_IN7 register (see the Alert Indicator Registers section).	0x0	R
5	LO_IN6	IN6 Lower Alert Indicator. This bit is set to 1 when a conversion result for IN6 is less than or equal to the IN6 lower threshold value. This indicator is only active if the threshold detection is enabled on IN6 (see the Threshold Detection and Alert Indicators section). This bit is read to clear. When the ALERT_MODE bit in the setup register is set to 1, this bit also automatically clears if a subsequent IN6 conversion is within the range set by the HYSTERESIS field in the HYST_IN6 register (see the Alert Indicator Registers section).	0x0	R
4	HI_IN6	IN6 Upper Alert Indicator. This bit is set to 1 when a conversion result for IN6 is greater than or equal to the IN6 upper threshold value. This indicator is only active if the threshold detection is enabled on IN6 (see the Threshold Detection and Alert Indicators section). This bit is read to clear. When the ALERT_MODE bit in the setup register is set to 1, this bit also automatically clears if a subsequent IN6 conversion is within the range set by the HYSTERESIS field in the HYST_IN6 register (see the Alert Indicator Registers section).	0x0	R
3	LO_IN5	IN5 Lower Alert Indicator. This bit is set to 1 when a conversion result for IN5 is less than or equal to the IN5 lower threshold value. This indicator is only active if the threshold detection is enabled on IN5 (see the Threshold Detection and Alert Indicators section). This bit is read to clear. When the ALERT_MODE bit in the setup register is set to 1, this bit also automatically clears if a subsequent IN5 conversion is within the range set by the HYSTERESIS field in the HYST_IN5 register (see the Alert Indicator Registers section).	0x0	R
2	HI_IN5	IN5 Upper Alert Indicator. This bit is set to 1 when a conversion result for IN5 is greater than or equal to the IN5 upper threshold value. This indicator is only active if the threshold detection is enabled on IN5 (see the Threshold Detection and Alert Indicators section). This bit is read to clear. When the ALERT_MODE bit in the setup register is set to 1, this bit also automatically clears if a subsequent IN5 conversion is within the range set by the HYSTERESIS field in the HYST_IN5 register (see the Alert Indicator Registers section).	0x0	R
1	LO_IN4	IN4 Lower Alert Indicator. This bit is set to 1 when a conversion result for IN4 is less than or equal to the IN4 lower threshold value. This indicator is only active if the threshold detection is enabled on IN4 (see the Threshold Detection and Alert Indicators section). This bit is read to clear. When the ALERT_MODE bit in the setup register is set to 1, this bit also automatically clears if a subsequent IN4 conversion is within the range set by the HYSTERESIS field in the HYST_IN4 register (see the Alert Indicator Registers section).	0x0	R
0	HI_IN4	IN4 Upper Alert Indicator. This bit is set to 1 when a conversion result for IN4 is greater than or equal to the IN4 upper threshold value. This indicator is only active if the threshold detection is enabled on IN4 (see the Threshold Detection and Alert Indicators section). This bit is read to clear. When the ALERT_MODE bit in the setup register is set to 1, this bit also automatically clears if a subsequent IN4 conversion is within the range set by the HYSTERESIS field in the HYST_IN4 register (see the Alert Indicator Registers section).	0x0	R

Alert Status (IN8 to IN11) Register

Address: 0x0017, Reset: 0x00, Name: ALERT_STATUS3

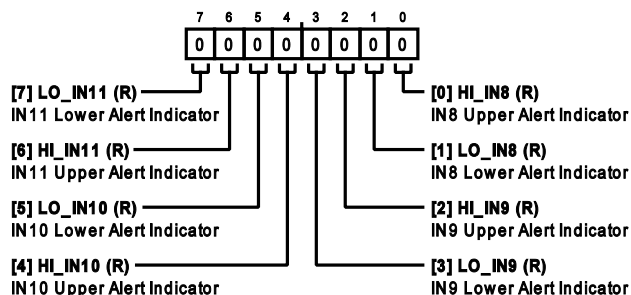

REGISTER INFORMATION

Table 44. Bit Descriptions for ALERT_STATUS3

Bits	Bit Name	Description	Reset	Access
7	LO_IN11	IN11 Lower Alert Indicator. This bit is set to 1 when a conversion result for IN11 is less than or equal to the IN11 lower threshold value. This indicator is only active if the threshold detection is enabled on IN0 (see the Threshold Detection and Alert Indicators section). This bit is read to clear. When the ALERT_MODE bit in the setup register is set to 1, this bit also automatically clears if a subsequent IN11 conversion is within the range set by the HYSTERESIS field in the HYST_IN11 register (see the Alert Indicator Registers section).	0x0	R
6	HI_IN11	IN11 Upper Alert Indicator. This bit is set to 1 when a conversion result for IN11 is greater than or equal to the IN11 upper threshold value. This indicator is only active if the threshold detection is enabled on IN11 (see the Threshold Detection and Alert Indicators section). This bit is read to clear. When the ALERT_MODE bit in the setup register is set to 1, this bit also automatically clears if a subsequent IN11 conversion is within the range set by the HYSTERESIS field in the HYST_IN11 register (see the Alert Indicator Registers section).	0x0	R
5	LO_IN10	IN10 Lower Alert Indicator. This bit is set to 1 when a conversion result for IN10 is less than or equal to the IN10 lower threshold value. This indicator is only active if the threshold detection is enabled on IN0 (see the Threshold Detection and Alert Indicators section). This bit is read to clear. When the ALERT_MODE bit in the setup register is set to 1, this bit also automatically clears if a subsequent IN10 conversion is within the range set by the HYSTERESIS field in the HYST_IN10 register (see the Alert Indicator Registers section).	0x0	R
4	HI_IN10	IN10 Upper Alert Indicator. This bit is set to 1 when a conversion result for IN10 is greater than or equal to the IN10 upper threshold value. This indicator is only active if the threshold detection is enabled on IN10 (see the Threshold Detection and Alert Indicators section). This bit is read to clear. When the ALERT_MODE bit in the setup register is set to 1, this bit also automatically clears if a subsequent IN10 conversion is within the range set by the HYSTERESIS field in the HYST_IN10 register (see the Alert Indicator Registers section).	0x0	R
3	LO_IN9	IN9 Lower Alert Indicator. This bit is set to 1 when a conversion result for IN9 is less than or equal to the IN9 lower threshold value. This indicator is only active if the threshold detection is enabled on IN9 (see the Threshold Detection and Alert Indicators section). This bit is read to clear. When the ALERT_MODE bit in the setup register is set to 1, this bit also automatically clears if a subsequent IN9 conversion is within the range set by the HYSTERESIS field in the HYST_IN9 register (see the Alert Indicator Registers section).	0x0	R
2	HI_IN9	IN9 Upper Alert Indicator. This bit is set to 1 when a conversion result for IN9 is greater than or equal to the IN9 upper threshold value. This indicator is only active if the threshold detection is enabled on IN9 (see the Threshold Detection and Alert Indicators section). This bit is read to clear. When the ALERT_MODE bit in the setup register is set to 1, this bit also automatically clears if a subsequent IN9 conversion is within the range set by the HYSTERESIS field in the HYST_IN9 register (see the Alert Indicator Registers section).	0x0	R
1	LO_IN8	IN8 Lower Alert Indicator. This bit is set to 1 when a conversion result for IN8 is less than or equal to the IN8 lower threshold value. This indicator is only active if the threshold detection is enabled on IN8 (see the Threshold Detection and Alert Indicators section). This bit is read to clear. When the ALERT_MODE bit in the setup register is set to 1, this bit also automatically clears if a subsequent IN8 conversion is within the range set by the HYSTERESIS field in the HYST_IN8 register (see the Alert Indicator Registers section).	0x0	R
0	HI_IN8	IN8 Upper Alert Indicator. This bit is set to 1 when a conversion result for IN8 is greater than or equal to the IN8 upper threshold value. This indicator is only active if the threshold detection is enabled on IN8 (see the Threshold Detection and Alert Indicators section). This bit is read to clear. When the ALERT_MODE bit in the setup register is set to 1, this bit also automatically clears if a subsequent IN8 conversion is within the range set by the HYSTERESIS field in the HYST_IN8 register (see the Alert Indicator Registers section).	0x0	R

Alert Status (IN12 to IN15) Register

Address: 0x0018, Reset: 0x00, Name: ALERT_STATUS4

REGISTER INFORMATION

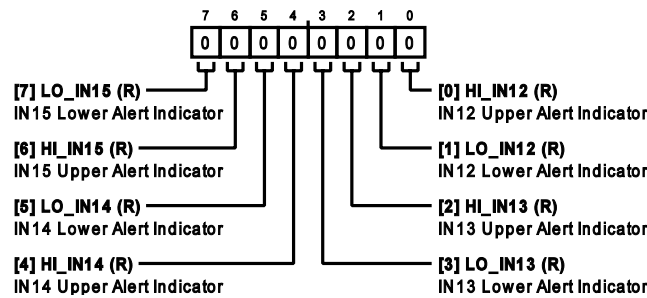

Table 45. Bit Descriptions for ALERT_STATUS4

Bits	Bit Name	Description	Reset	Access
7	LO_IN15	IN15 Lower Alert Indicator. This bit is set to 1 when a conversion result for IN15 is less than or equal to the IN15 lower threshold value. This indicator is only active if the threshold detection is enabled on IN0 (see the Threshold Detection and Alert Indicators section). This bit is read to clear. When the ALERT_MODE bit in the setup register is set to 1, this bit also automatically clears if a subsequent IN15 conversion is within the range set by the HYSTERESIS field in the HYST_IN15 register (see the Alert Indicator Registers section).	0x0	R
6	HI_IN15	IN15 Upper Alert Indicator. This bit is set to 1 when a conversion result for IN15 is greater than or equal to the IN15 upper threshold value. This indicator is only active if the threshold detection is enabled on IN15 (see the Threshold Detection and Alert Indicators section). This bit is read to clear. When the ALERT_MODE bit in the setup register is set to 1, this bit also automatically clears if a subsequent IN15 conversion is within the range set by the HYSTERESIS field in the HYST_IN15 register (see the Alert Indicator Registers section).	0x0	R
5	LO_IN14	IN14 Lower Alert Indicator. This bit is set to 1 when a conversion result for IN14 is less than or equal to the IN14 lower threshold value. This indicator is only active if the threshold detection is enabled on IN0 (see the Threshold Detection and Alert Indicators section). This bit is read to clear. When the ALERT_MODE bit in the setup register is set to 1, this bit also automatically clears if a subsequent IN14 conversion is within the range set by the HYSTERESIS field in the HYST_IN14 register (see the Alert Indicator Registers section).	0x0	R
4	HI_IN14	IN14 Upper Alert Indicator. This bit is set to 1 when a conversion result for IN14 is greater than or equal to the IN14 upper threshold value. This indicator is only active if the threshold detection is enabled on IN14 (see the Threshold Detection and Alert Indicators section). This bit is read to clear. When the ALERT_MODE bit in the setup register is set to 1, this bit also automatically clears if a subsequent IN14 conversion is within the range set by the HYSTERESIS field in the HYST_IN14 register (see the Alert Indicator Registers section).	0x0	R
3	LO_IN13	IN13 Lower Alert Indicator. This bit is set to 1 when a conversion result for IN13 is less than or equal to the IN13 lower threshold value. This indicator is only active if the threshold detection is enabled on IN0 (see the Threshold Detection and Alert Indicators section). This bit is read to clear. When the ALERT_MODE bit in the setup register is set to 1, this bit also automatically clears if a subsequent IN13 conversion is within the range set by the HYSTERESIS field in the HYST_IN13 register (see the Alert Indicator Registers section).	0x0	R
2	HI_IN13	IN13 Upper Alert Indicator. This bit is set to 1 when a conversion result for IN13 is greater than or equal to the IN13 upper threshold value. This indicator is only active if the threshold detection is enabled on IN13 (see the Threshold Detection and Alert Indicators section). This bit is read to clear. When the ALERT_MODE bit in the setup register is set to 1, this bit also automatically clears if a subsequent IN13 conversion is within the range set by the HYSTERESIS field in the HYST_IN13 register (see the Alert Indicator Registers section).	0x0	R
1	LO_IN12	IN12 Lower Alert Indicator. This bit is set to 1 when a conversion result for IN12 is less than or equal to the IN12 lower threshold value. This indicator is only active if the threshold detection is enabled on IN0 (see the Threshold Detection and Alert Indicators section). This bit is read to clear. When the ALERT_MODE bit in the setup register is set to 1, this bit also automatically clears if a subsequent IN12 conversion is within the range set by the HYSTERESIS field in the HYST_IN12 register (see the Alert Indicator Registers section).	0x0	R
0	HI_IN12	IN12 Upper Alert Indicator. This bit is set to 1 when a conversion result for IN12 is greater than or equal to the IN12 upper threshold value. This indicator is only active if the threshold detection is enabled on IN12 (see the Threshold Detection and Alert Indicators section). This bit is read to clear. When the ALERT_MODE bit in the setup register is set to 1, this bit also automatically clears if a subsequent IN12 conversion is within the range set by the HYSTERESIS field in the HYST_IN12 register (see the Alert Indicator Registers section).	0x0	R

REGISTER INFORMATION

Clamp Status (IN0 to IN7) Register

Address: 0x001A, Reset: 0x00, Name: CLAMP_STATUS1

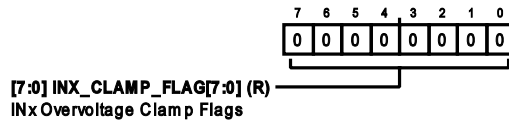

Table 46. Bit Descriptions for CLAMP_STATUS1

Bits	Bit Name	Description	Reset	Access
[7:0]	INX_CLAMP_FLAG[7:0]	INx Overvoltage Clamp Flags. This field indicates if the INx overvoltage protection clamps are active because of an overvoltage event. Each bit corresponds to one of the analog inputs (IN0 to IN15), where INX_CLAMP_FLAG[x] corresponds to the INx overvoltage protection clamp status. INX_CLAMP_FLAG[x] is set to 1 when the INx overvoltage protection clamp is active. These bits are not sticky and are automatically cleared when the corresponding overvoltage protection clamp deactivates.	0x0	R

Clamp Status (IN8 to IN15) Register

Address: 0x001B, Reset: 0x00, Name: CLAMP_STATUS2

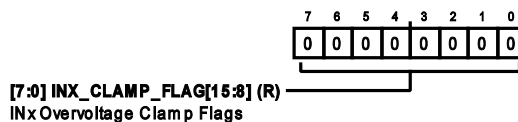

Table 47. Bit Descriptions for CLAMP_STATUS2

Bits	Bit Name	Description	Reset	Access
[7:0]	INX_CLAMP_FLAG[15:8]	INx Overvoltage Clamp Flags. This field indicates if the INx overvoltage protection clamps are active because of an overvoltage event. Each bit corresponds to one of the analog inputs (IN0 to IN15), where INX_CLAMP_FLAG[x] corresponds to the INx overvoltage protection clamp status. INX_CLAMP_FLAG[x] is set to 1 while the INx overvoltage protection clamp is active. These bits are not sticky and are automatically cleared when their corresponding overvoltage protection clamp deactivates.	0x0	R

Device Setup Register

Address: 0x0020, Reset: 0x10, Name: SETUP

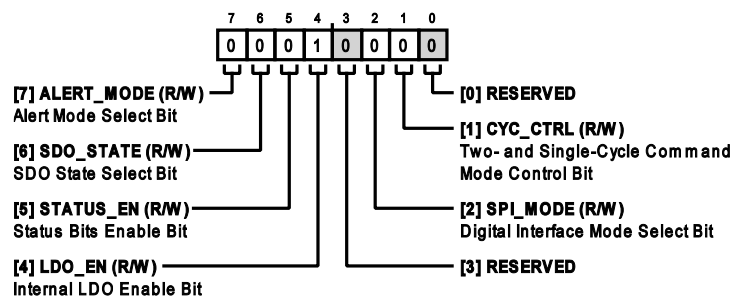

Table 48. Bit Descriptions for SETUP

Bits	Bit Name	Description	Reset	Access
7	ALERT_MODE	Alert Mode Select Bit. This bit determines how the upper and lower alert indicators (HI_INn and LO_INn) are cleared (see the Alert Indicator Registers section). 0: hysteresis enabled.	0x0	R/W

REGISTER INFORMATION

Table 48. Bit Descriptions for SETUP

Bits	Bit Name	Description	Reset	Access
6	SDO_STATE	1: hysteresis disabled. SDO State Select Bit. This bit determines the behavior of serial data output(s) at the beginning and end of conversion mode SPI frames (see the Conversion Mode Timing Diagrams section). 0: serial data output(s) hold the final value until the MSB of the next conversion data is clocked out. 1: busy indicator is enabled on the serial data output(s).	0x0	R/W
5	STATUS_EN	Status Bits Enable Bit. This bit determines whether the status bits are appended to conversion data when in conversion mode (see the Status Bits section). 0: status bits disabled. 1: status bits enabled.	0x0	R/W
4	LDO_EN	Internal LDO Enable Bit. This bit enables or disables the internal LDO. Disable the internal LDO when driving VDD with an external 1.8 V supply. When the internal LDO is supplying VDD, disabling the internal LDO removes power to VDD and disables the ADC core and configuration registers (see the Internal LDO section). 0: internal LDO disabled. 1: internal LDO enabled.	0x1	R/W
3	RESERVED	Reserved.	0x0	R/W
2	SPI_MODE	Digital Interface Mode Select Bit. This bit determines whether the device is in register configuration mode or conversion mode. Set this bit to 1 to enter conversion mode. This bit is set to 0 when the register configuration mode command is received (see the Register Configuration Mode Command section). 0: selects register configuration mode. 1: selects conversion mode.	0x0	R/W
1	CYC_CTRL	Two- and Single-Cycle Command Mode Control Bit. This bit selects between two-cycle command mode and single-cycle command mode. This bit must be set to 0 when using two-cycle command mode, the standard sequencer, or the advanced sequencer (see the Channel Sequencing Modes section). 0: selects two-cycle command mode. 1: selects single-cycle command mode.	0x0	R/W
0	RESERVED	Reserved.	0x0	R/W

Reference Control Register

Address: 0x0021, Reset: 0x12, Name: REF_CTRL

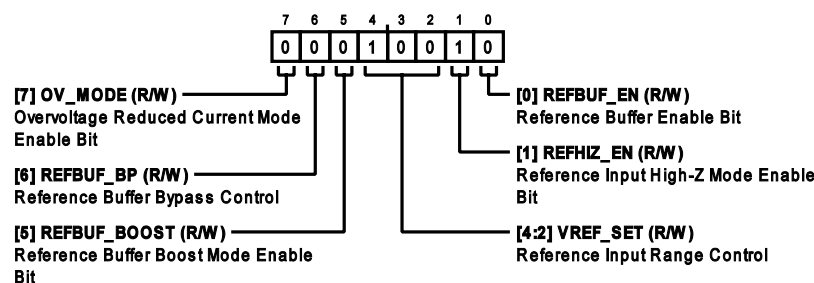

Table 49. Bit Descriptions for REF_CTRL

Bits	Bit Name	Description	Reset	Access
7	OV_MODE	Overvoltage Reduced Current Mode Enable Bit. This bit enables or disables overvoltage reduced current mode (see the Input Overvoltage Protection Clamps section). 0: reduce REF current during clamping. 1: do not reduce REF current during clamping.	0x0	R/W
6	REFBUF_BP	Reference Buffer Bypass Control. Determines whether the reference buffer is bypassed (see the Internal Reference Buffer section). If the REFBUF_EN bit is set to 1, the reference buffer is not bypassed and this bit is ignored. This bit is only active on the WLCSP option. Setting this bit on the LFCSP option has no effect.	0x0	R/W

REGISTER INFORMATION

Table 49. Bit Descriptions for REF_CTRL

Bits	Bit Name	Description	Reset	Access
		0: internal reference buffer not bypassed. 1: internal reference buffer bypassed.		
5	REFBUF_BOOST	Reference Buffer Boost Mode Enable Bit. Enables or disables reference buffer boost mode (see the Internal Reference Buffer section). This bit is only active on the WLCSP option. Setting this bit on the LFCSP option has no effect. 0: reference buffer boost mode disabled. 1: reference buffer boost mode enabled.	0x0	R/W
[4:2]	VREF_SET	Reference Input Range Control. This field configures the device to optimize performance based on the reference voltage in use. This field must be programmed to match the V_{REF} voltage applied to the REF pin (see the Voltage Reference Input section). 0x0: $2.4\text{ V} \leq V_{REF} \leq 2.75\text{ V}$. 0x1: $2.75\text{ V} < V_{REF} \leq 3.25\text{ V}$. 0x2: $3.25\text{ V} < V_{REF} \leq 3.75\text{ V}$. 0x3: $3.75\text{ V} < V_{REF} \leq 4.50\text{ V}$. 0x4: $4.5\text{ V} < V_{REF} \leq 5.10\text{ V}$.	0x4	R/W
1	REFHIZ_EN	Reference Input High-Z Mode Enable Bit. This bit enables or disables reference input high-Z mode (see the Reference Input High-Z Mode section). 0: disable reference input high-Z mode. 1: enable reference input high-Z mode.	0x1	R/W
0	REFBUF_EN	Reference Buffer Enable Bit. Enables or disables the reference buffer. Setting REFBUF_EN to 1 also forces the reference buffer bypass switch to be open (see the Internal Reference Buffer section). This bit is only active on the WLCSP option. Setting this bit on the LFCSP option has no effect. 0: disables internal reference buffer. 1: enables internal reference buffer.	0x0	R/W

Sequencer Control Register

Address: 0x0022, Reset: 0x80, Name: SEQ_CTRL

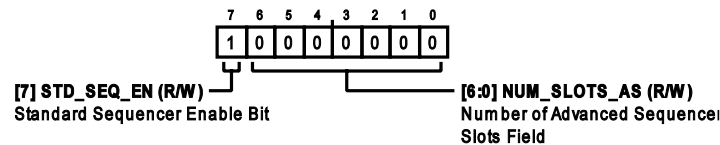

Table 50. Bit Descriptions for SEQ_CTRL

Bits	Bit Name	Description	Reset	Access
7	STD_SEQ_EN	Standard Sequencer Enable Bit. This bit enables or disables the standard sequencer (see the Channel Sequencing Modes section). 0: standard sequencer disabled. 1: standard sequencer enabled.	0x1	R/W
[6:0]	NUM_SLOTS_AS	Number of Advanced Sequencer Slots Field. This field determines the number of slots in a sequence when the advanced sequencer is enabled. The number of slots is equal to NUM_SLOTS_AS + 1. This field must be set to 0x00 to enable two-cycle command mode or single-cycle command mode (see the Channel Sequencing Modes section).	0x0	R/W

Autocycle Control Register

Address: 0x0023, Reset: 0x00, Name: AC_CTRL

REGISTER INFORMATION

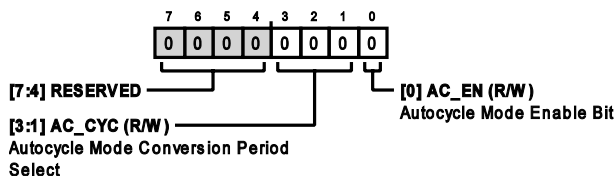
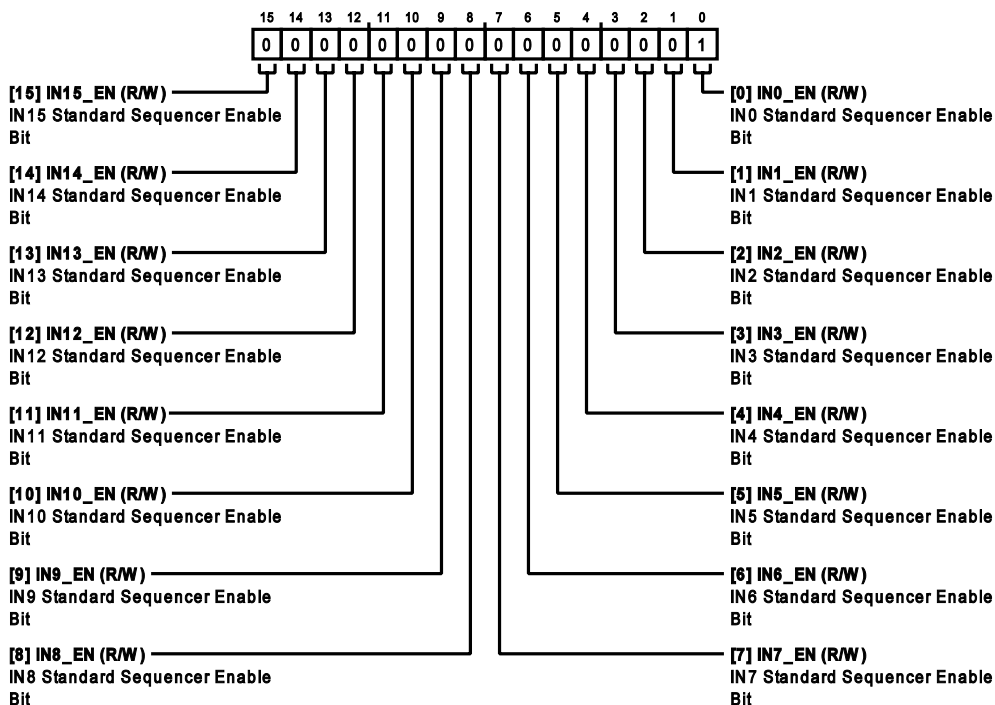

Table 51. Bit Descriptions for AC_CTRL

Bits	Bit Name	Description	Reset	Access
[7:4]	RESERVED	Reserved.	0x0	R
[3:1]	AC_CYC	Autocycle Mode Conversion Period Select. This field sets the period of the internal convert start signal when autocycle mode is enabled (see the Autocycle Mode section). 0x0: autocycle conversion period = 10 μs. 0x1: autocycle conversion period = 20 μs. 0x2: autocycle conversion period = 40 μs. 0x3: autocycle conversion period = 80 μs. 0x4: autocycle conversion period = 100 μs. 0x5: autocycle conversion period = 200 μs. 0x6: autocycle conversion period = 400 μs. 0x7: autocycle conversion period = 800 μs.	0x0	R/W
0	AC_EN	Autocycle Mode Enable Bit. This bit enables or disables autocycle mode (see the Autocycle Mode section). 0: autocycle mode disabled. 1: autocycle mode enabled.	0x0	R/W

Standard Sequencer Configuration Register

Address: 0x0024, Reset: 0x0001, Name: STD_SEQ_CONFIG



REGISTER INFORMATION

Table 52. Bit Descriptions for STD_SEQ_CONFIG

Bits	Bit Name	Description	Reset	Access
15	IN15_EN	IN15 Standard Sequencer Enable Bit. When This bit is set to 1, IN15 is included in the channel sequence when the standard sequencer is enabled (see the Standard Sequencer section).	0x0	R/W
14	IN14_EN	IN14 Standard Sequencer Enable Bit. When This bit is set to 1, IN14 is included in the channel sequence when the standard sequencer is enabled (see the Standard Sequencer section).	0x0	R/W
13	IN13_EN	IN13 Standard Sequencer Enable Bit. When This bit is set to 1, IN13 is included in the channel sequence when the standard sequencer is enabled (see the Standard Sequencer section).	0x0	R/W
12	IN12_EN	IN12 Standard Sequencer Enable Bit. When This bit set to 1, IN12 is included in the channel sequence when the standard sequencer is enabled (see the Standard Sequencer section).	0x0	R/W
11	IN11_EN	IN11 Standard Sequencer Enable Bit. When This bit is set to 1, IN11 is included in the channel sequence when the standard sequencer is enabled (see the Standard Sequencer section).	0x0	R/W
10	IN10_EN	IN10 Standard Sequencer Enable Bit. When This bit is set to 1, IN10 is included in the channel sequence when the standard sequencer is enabled (see the Standard Sequencer section).	0x0	R/W
9	IN9_EN	IN9 Standard Sequencer Enable Bit. When This bit is set to 1, IN9 is included in the channel sequence when the standard sequencer is enabled (see the Standard Sequencer section).	0x0	R/W
8	IN8_EN	IN8 Standard Sequencer Enable Bit. When This bit is set to 1, IN8 is included in the channel sequence when the standard sequencer is enabled (see the Standard Sequencer section).	0x0	R/W
7	IN7_EN	IN7 Standard Sequencer Enable Bit. When This bit is set to 1, IN7 is included in the channel sequence when the standard sequencer is enabled (see the Standard Sequencer section).	0x0	R/W
6	IN6_EN	IN6 Standard Sequencer Enable Bit. When This bit is set to 1, IN6 is included in the channel sequence when the standard sequencer is enabled (see the Standard Sequencer section).	0x0	R/W
5	IN5_EN	IN5 Standard Sequencer Enable Bit. When This bit is set to 1, IN5 is included in the channel sequence when the standard sequencer is enabled (see the Standard Sequencer section).	0x0	R/W
4	IN4_EN	IN4 Standard Sequencer Enable Bit. When This bit is set to 1, IN4 is included in the channel sequence when the standard sequencer is enabled (see the Standard Sequencer section).	0x0	R/W
3	IN3_EN	IN3 Standard Sequencer Enable Bit. When This bit is set to 1, IN3 is included in the channel sequence when the standard sequencer is enabled (see the Standard Sequencer section).	0x0	R/W
2	IN2_EN	IN2 Standard Sequencer Enable Bit. When This bit is set to 1, IN2 is included in the channel sequence when the standard sequencer is enabled (see the Standard Sequencer section).	0x0	R/W
1	IN1_EN	IN1 Standard Sequencer Enable Bit. When This bit is set to 1, IN1 is included in the channel sequence when the standard sequencer is enabled (see the Standard Sequencer section).	0x0	R/W
0	IN0_EN	IN0 Standard Sequencer Enable Bit. When This bit is set to 1, IN0 is included in the channel sequence when the standard sequencer is enabled (see the Standard Sequencer section).	0x1	R/W

GPIO Enable Register

Address: 0x0026, Reset: 0x00, Name: GPIO_CTRL

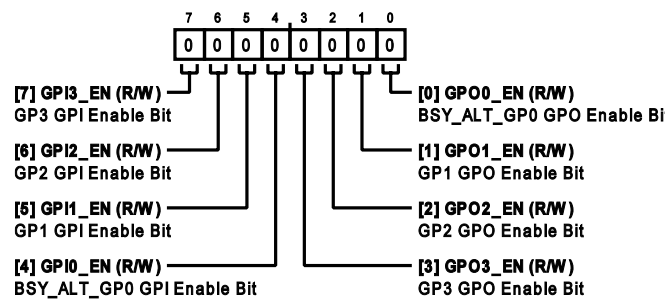

REGISTER INFORMATION

Table 53. Bit Descriptions for GPIO_CTRL

Bits	Bit Name	Description	Reset	Access
7	GPI3_EN	GP3 GPI Enable Bit. Configures the GP3 pin as a general-purpose input if the higher priority functions are disabled (see the GPIO section). This bit is only active on the WLCSP option. Setting this bit on the LFCSP option has no effect. 0: general-purpose input function on GP3 disabled. 1: general-purpose input function on GP3 enabled.	0x0	R/W
6	GPI2_EN	GP2 GPI Enable Bit. Configures the GP2 pin as a general-purpose input if the higher priority functions are disabled (see the GPIO section). This bit is only active on the WLCSP option. Setting this bit on the LFCSP option has no effect. 0: general-purpose input function on GP2 disabled. 1: general-purpose input function on GP2 enabled.	0x0	R/W
5	GPI1_EN	GP1 GPI Enable Bit. Configures the GP1 pin as a general-purpose input if the higher priority functions are disabled (see the GPIO section). This bit is only active on the WLCSP option. Setting this bit on the LFCSP option has no effect. 0: general-purpose input function on GP1 disabled. 1: general-purpose input function on GP1 enabled.	0x0	R/W
4	GPI0_EN	BSY_ALT_GP0 GPI Enable Bit. Configures the BSY_ALT_GP0 pin as a general-purpose input if the higher priority functions are disabled (see the GPIO section). 0: general-purpose input function on BSY_ALT_GP0 disabled. 1: general-purpose input function on BSY_ALT_GP0 enabled.	0x0	R/W
3	GPO3_EN	GP3 GPO Enable Bit. Configures the GP3 pin as a general-purpose output if the higher priority functions are disabled (see the GPIO section). This bit is only active on the WLCSP option. Setting this bit on the LFCSP option has no effect. 0: general-purpose output function on GP3 disabled. 1: general-purpose output function on GP3 disabled.	0x0	R/W
2	GPO2_EN	GP2 GPO Enable Bit. Configures the GP2 pin as a general-purpose output if the higher priority functions are disabled (see the GPIO section). This bit is only active on the WLCSP option. Setting this bit on the LFCSP option has no effect. 0: general-purpose output function on GP2 disabled. 1: general-purpose output function on GP2 enabled.	0x0	R/W
1	GPO1_EN	GP1 GPO Enable Bit. Configures the GP1 pin as a general-purpose output if the higher priority functions are disabled (see the GPIO section). This bit is only active on the WLCSP option. Setting this bit on the LFCSP option has no effect. 0: general-purpose output function on GP1 disabled. 1: general-purpose output function on GP1 enabled.	0x0	R/W
0	GPO0_EN	BSY_ALT_GP0 GPO Enable Bit. Configures the BSY_ALT_GP0 pin as a general-purpose output if all higher priority functions are disabled (see the GPIO section). 0: general-purpose output function on BSY_ALT_GP0 disabled. 1: general-purpose output function on BSY_ALT_GP0 enabled.	0x0	R/W

General-Purpose Pin Function Control Register

Address: 0x0027, Reset: 0x00, Name: GP_MODE

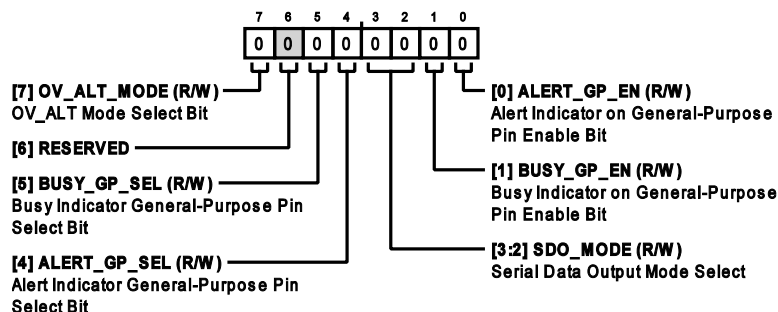

REGISTER INFORMATION

Table 54. Bit Descriptions for GP_MODE

Bits	Bit Name	Description	Reset	Access
7	OV_ALT_MODE	OV_ALT Mode Select Bit. This bit configures the OV_ALT bit in the status bits to report the state of the threshold detection alert indicator (see the Status Bits section). 0: does not configure the OV_ALT bit to report the state of the TD_ALERT bit. 1: configures the OV_ALT bit to report the state of the TD_ALERT bit.	0x0	R/W
6	RESERVED	Reserved.	0x0	R
5	BUSY_GP_SEL	Busy Indicator General-Purpose Pin Select Bit. Selects which general-purpose pin the busy indicator is enabled on when the BUSY_GP_EN bit is set to 1. This bit is only active on the WLCSP option. Setting this bit on the LFCSP option has no effect. 0: configures BSY_ALT_GP0 as the busy indicator when the BUSY_GP_EN bit is set to 1. 1: configures GP3 as the busy indicator when the BUSY_GP_EN bit is set to 1.	0x0	R/W
4	ALERT_GP_SEL	Alert Indicator General-Purpose Pin Select Bit. Selects which general-purpose pin the alert indicator is enabled on when the ALERT_GP_EN bit is set to 1. This bit is only active on the WLCSP option. Setting this bit on the LFCSP option has no effect. 0: Configures BSY_ALT_GP0 as the alert indicator when the ALERT_GP_EN bit is set to 1. 1: Configures GP2 as the alert indicator when the ALERT_GP_EN bit is set to 1.	0x0	R/W
[3:2]	SDO_MODE	Serial Data Output Mode Select. This field selects the serial data output mode. 0: single-SDO mode enabled. 1: dual-SDO mode enabled. 01 (LFCSP option): single-SDO mode enabled. 01 (WLCSP option): quad-SDO mode enabled. 11: single-SDO mode enabled.	0x0	R/W
1	BUSY_GP_EN	Busy Indicator on General-Purpose Pin Enable Bit. Enables or disables the busy indicator on the general-purpose pin selected by the BUSY_GP_SEL bit if all higher priority functions are disabled (see the General-Purpose Pins section). 0: busy indicator on the general-purpose pin function disabled. 1: busy indicator on the general-purpose pin function enabled.	0x0	R/W
0	ALERT_GP_EN	Alert Indicator on General-Purpose Pin Enable Bit. Enables or disables the alert indicator on the general-purpose pin selected by the ALERT_GP_SEL bit if all higher priority functions are disabled (see the General-Purpose Pins section). 0: alert indicator on the general-purpose pin function disabled. 1: alert indicator on the general-purpose pin function enabled.	0x0	R/W

GPIO State Register

Address: 0x0028, Reset: 0x00, Name: GPIO_STATE

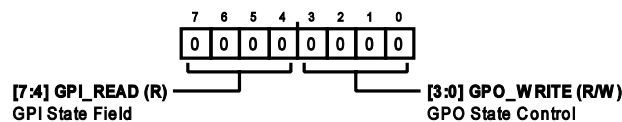

Table 55. Bit Descriptions for GPIO_STATE

Bits	Bit Name	Description	Reset	Access
[7:4]	GPI_READ	GPI State Field. Displays the state of each general-purpose pin configured as a general-purpose input (see the GPIO section). GPI_READ[3:1] always return 0 on the LFCSP option.	0x0	R
[3:0]	GPO_WRITE	GPO State Control. Sets the state of each general-purpose pin configured as a general-purpose output (see the GPIO section). GPO_WRITE[3:1] are only active on the WLCSP option. Setting these bits on the LFCSP option has no effect.	0x0	R/W

REGISTER INFORMATION

Temperature Sensor Control Register

Address: 0x0029, Reset: 0x00, Name: TEMP_CTRL

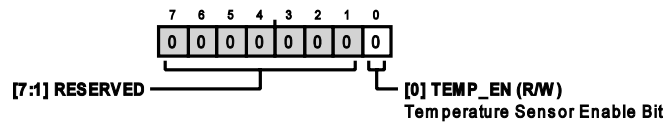

Table 56. Bit Descriptions for TEMP_CTRL

Bits	Bit Name	Description	Reset	Access
[7:1]	RESERVED	Reserved.	0x0	R
0	TEMP_EN	Temperature Sensor Enable Bit. This bit enables or disables the temperature sensor in the channel sequence when the standard sequencer or advanced sequencer is enabled (see the Temperature Sensor section). 0: temperature sensor not included in the channel sequence. 1: temperature sensor included in the channel sequence.	0x0	R/W

Analog Input Settings Configuration Register

Address: 0x0030 to Address 0x003F (Increments of 0x0001), Reset: 0x08, Name: CONFIG_INn

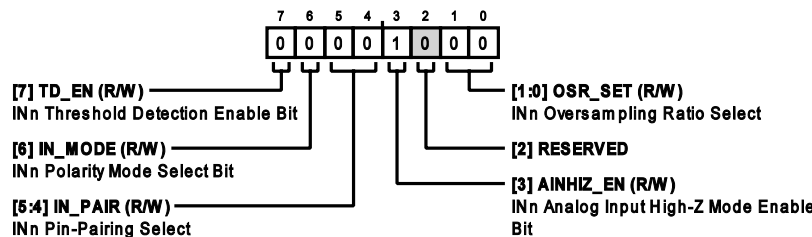

Table 57. Bit Descriptions for CONFIG_INn

Bits	Bit Name	Description	Reset	Access
7	TD_EN	INn Threshold Detection Enable Bit. When the standard sequencer is enabled, the TD_EN bit in the CONFIG_IN0 register enables or disables threshold detection for IN0 to IN15. When the advanced sequencer is enabled, the TD_EN bit in each CONFIG_INn register enables or disables threshold detection only for its corresponding INn analog input. The HI_INn and LO_INn alert indicator bits are active when threshold detection is enabled on the corresponding INn analog input (see the Threshold Detection and Alert Indicators section). 0: disables threshold detection for INn. 1: enables threshold detection for INn.	0x0	R/W
6	IN_MODE	INn Polarity Mode Select Bit. This bit selects the polarity mode for the corresponding INn analog input (see the Channel Configuration Options section). Unlike the other control bits in the CONFIG_INn registers, the polarity mode for each INn analog input is always set by the IN_MODE bit in its corresponding CONFIG_INn register, regardless of the channel sequencing mode. 0: selects unipolar mode for INn. 1: selects pseudobipolar mode for INn.	0x0	R/W
[5:4]	IN_PAIR	INn Pin-Pairing Select. This field selects the pin pairing option for the corresponding INn analog input (see the Channel Configuration Options section). When the standard sequencer is enabled, the IN_PAIR field in the CONFIG_IN0 register sets the pin pairing option for IN0 to IN15. When the advanced sequencer is enabled, the IN_PAIR bit in each CONFIG_INn register sets the pin pairing option only for its corresponding INn analog input. 0x0: INn paired with REFGND. 0x1: INn paired with COM. 0x2: even and odd input paired. 0x3: invalid.	0x0	R/W

REGISTER INFORMATION

Table 57. Bit Descriptions for CONFIG_INn

Bits	Bit Name	Description	Reset	Access
3	AINHIZ_EN	INn Analog Input High-Z Mode Enable Bit. When the standard sequencer is enabled, the AINHIZ_EN bit in the CONFIG_IN0 register enables or disables analog input high-Z mode for IN0 to IN15. When the advanced sequencer is enabled, the AINHIZ_EN bit in each CONFIG_INn register enables or disables analog input high-Z mode only for its corresponding INn analog input (see the Analog Input High-Z Mode section). 0: disables analog input high-Z mode for INn. 1: enables analog input high-Z mode for INn.	0x1	R/W
2	RESERVED	Reserved.	0x0	R
[1:0]	OSR_SET	INn Oversampling Ratio Select. When the standard sequencer is enabled, the OSR_SET field in the CONFIG_IN0 register sets the OSR for IN0 thru IN15. When the advanced sequencer is enabled, the OSR_SET field in each CONFIG_INn register sets the OSR only for its corresponding INn analog input. Set the OSR_SET fields in all CONFIG_INn registers to 0x0 when two-cycle command mode or single-cycle command mode are enabled (see the Oversampling and Decimation section). 0x0: OSR = 1 (no oversampling). 0x1: OSR = 4. Output code result resolution increases to 17 bits. 0x2: OSR = 16. Output code result resolution increases to 18 bits. 0x3: OSR = 64. Output code result resolution increases to 19 bits.	0x0	R/W

Upper Threshold Value Register

Address: 0x0040 to Address 0x005E (Increments of 0x0002), Reset: 0x07FF, Name: UPPER_INn

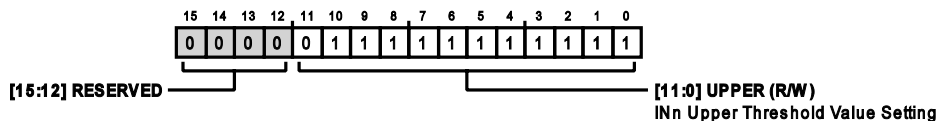

Table 58. Bit Descriptions for UPPER_INn

Bits	Bit Name	Description	Reset	Access
[15:12]	RESERVED	Reserved.	0x0	R
[11:0]	UPPER	INn Upper Threshold Value Setting. This field determines the upper threshold value for the corresponding INn analog input (see the Threshold Detection and Alert Indicators section). The value in the UPPER field corresponds to the 12 MSBs of the ADC result.	0x7FF	R/W

Lower Threshold Value Register

Address: 0x0060 to Address 0x007E (Increments of 0x0002), Reset: 0x0000, Name: LOWER_INn

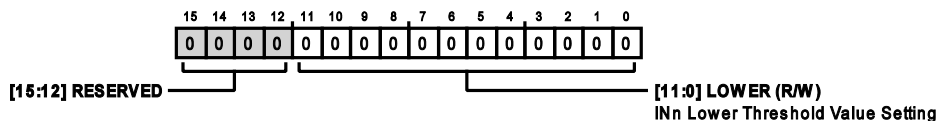

Table 59. Bit Descriptions for LOWER_INn

Bits	Bit Name	Description	Reset	Access
[15:12]	RESERVED	Reserved.	0x0	R
[11:0]	LOWER	INn Lower Threshold Value Setting. This field determines the lower threshold value for the corresponding INn analog input (see the Threshold Detection and Alert Indicators section). The value in the LOWER field corresponds to the 12 MSBs in the ADC result.	0x0	R/W

REGISTER INFORMATION

Hysteresis Setting Register

Address: 0x0080 to Address 0x009E (Increments of 0x0002), Reset: 0x0010, Name: HYST_INn

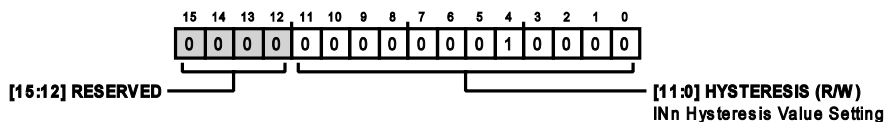

Table 60. Bit Descriptions for HYST_INn

Bits	Bit Name	Description	Reset	Access
[15:12]	RESERVED	Reserved.	0x0	R
[11:0]	HYSTERESIS	INn Hysteresis Value Setting. This field determines the hysteresis value for the corresponding INn analog input (see the Threshold Detection and Alert Indicators section). The value in the HYSTERESIS field corresponds to the 12 MSBs in the ADC result.	0x10	R/W

INn Offset Correction Register

Address: 0x00A0 to Address 0x00BE (Increments of 0x0002), Reset: 0x0000, Name: OFFSET_INn

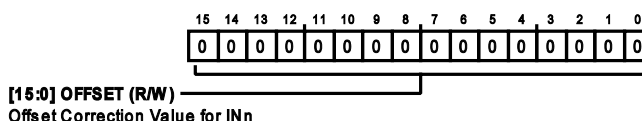

Table 61. Bit Descriptions for OFFSET_INn

Bits	Bit Name	Description	Reset	Access
[15:0]	OFFSET	Offset Correction Value for INn. This register sets the offset correction applied to results from the INn channel. See the Offset and Gain Correction section for a detailed description of offset correction.	0x0	R/W

INn Gain Correction Register

Address: 0x00C0 to Address 0x00DE (Increments of 0x0002), Reset: 0x8000, Name: GAIN_INn

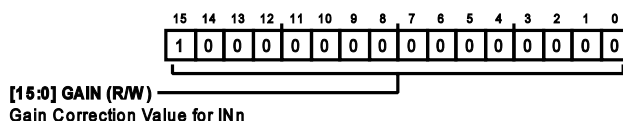
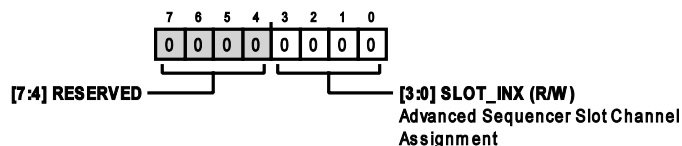

Table 62. Bit Descriptions for GAIN_INn

Bits	Bit Name	Description	Reset	Access
[15:0]	GAIN	Gain Correction Value for INn. This register sets the gain correction applied to results from the INn channel. See the Offset and Gain Correction section for a detailed description of gain correction.	0x8000	R/W

Advanced Sequencer Slot Register

Address: 0x0100 to Address 0x017F (Increments of 0x0001), Reset: 0x00, Name: AS_SLOTn



REGISTER INFORMATION

Table 63. Bit Descriptions for AS_SLOTn

Bits	Bit Name	Description	Reset	Access
[7:4]	RESERVED	Reserved.	0x0	R
[3:0]	SLOT_INX	Advanced Sequencer Slot Channel Assignment. This field determines which of the 16 analog inputs (INx) is assigned to slot n (see the Advanced Sequencer section). 0x0: IN0. 0x1: IN1. 0x2: IN2. 0x3: IN3. 0x4: IN4. 0x5: IN5. 0x6: IN6. 0x7: IN7. 0x8: IN8. 0x9: IN9. 0xA: IN10. 0xB: IN11. 0xC: IN12. 0xD: IN13. 0xE: IN14. 0xF: IN15.	0x0	R/W

OUTLINE DIMENSIONS

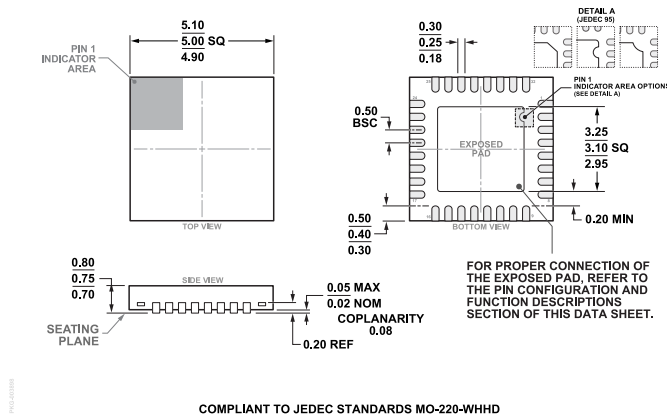

**Figure 128. 32-Lead Lead Frame Chip Scale Package [LFCSP]
5 mm × 5 mm Body and 0.75 mm Package Height
(CP-32-7)
Dimensions shown in millimeters**

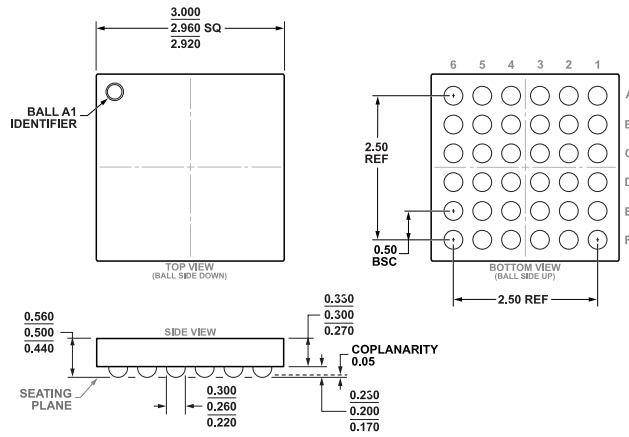

**Figure 129. 36-Ball Wafer Level Chip Scale Package (WLCSF)
(CB-36-5)
Dimensions shown in millimeters**

Updated: April 22, 2022

ORDERING GUIDE

Model ¹	Temperature Range	Package Description	Packing Quantity	Package Option
AD4695BCPZ	-40°C to +125°C	32-Lead LFCSP	Tray	CP-32-7
AD4695BCPZ-RL7	-40°C to +125°C	32-Lead LFCSP	Reel, 1500	CP-32-7
AD4695BCBZ-RL7	-40°C to +125°C	36-Ball WLCSF	Reel, 1500	CB-36-5
AD4696BCPZ	-40°C to +125°C	32-Lead LFCSP	Tray	CP-32-7
AD4696BCPZ-RL7	-40°C to +125°C	32-Lead LFCSP	Reel, 1500	CP-32-7
AD4696BCBZ-RL7	-40°C to +125°C	36-Ball WLCSF	Reel, 1500	CB-36-5

¹ Z = RoHS Compliant Part.

OUTLINE DIMENSIONS**EVALUATION BOARDS**

Model ¹	Description
EVAL-AD4696FMCZ	Evaluation Board for AD4696

¹ Z = RoHS Compliant Part.

Mouser Electronics

Authorized Distributor

Click to View Pricing, Inventory, Delivery & Lifecycle Information:

[Analog Devices Inc.:](#)

[AD4695BCPZ](#) [AD4695BCPZ-RL7](#) [AD4696BCPZ](#) [AD4696BCPZ-RL7](#) [AD4695BCBZ-RL7](#) [AD4696BCBZ-RL7](#)