

Ausführung EM/ET 208 F/
type EM/ET 208 F

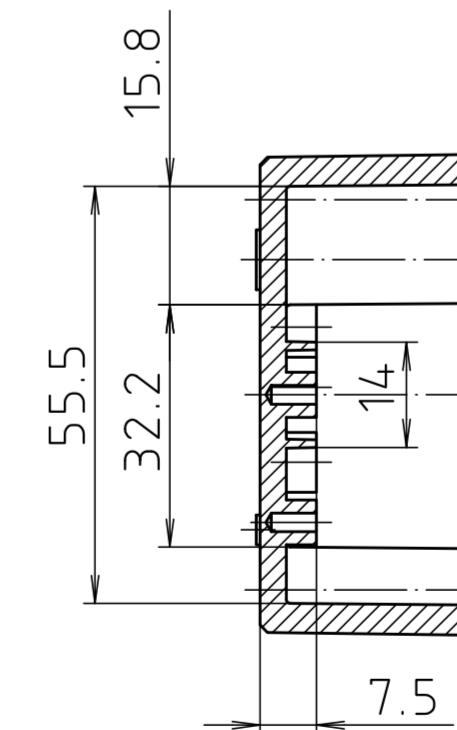
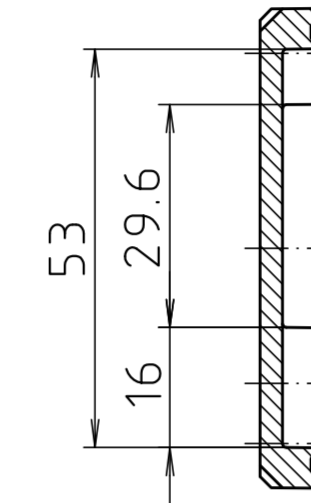
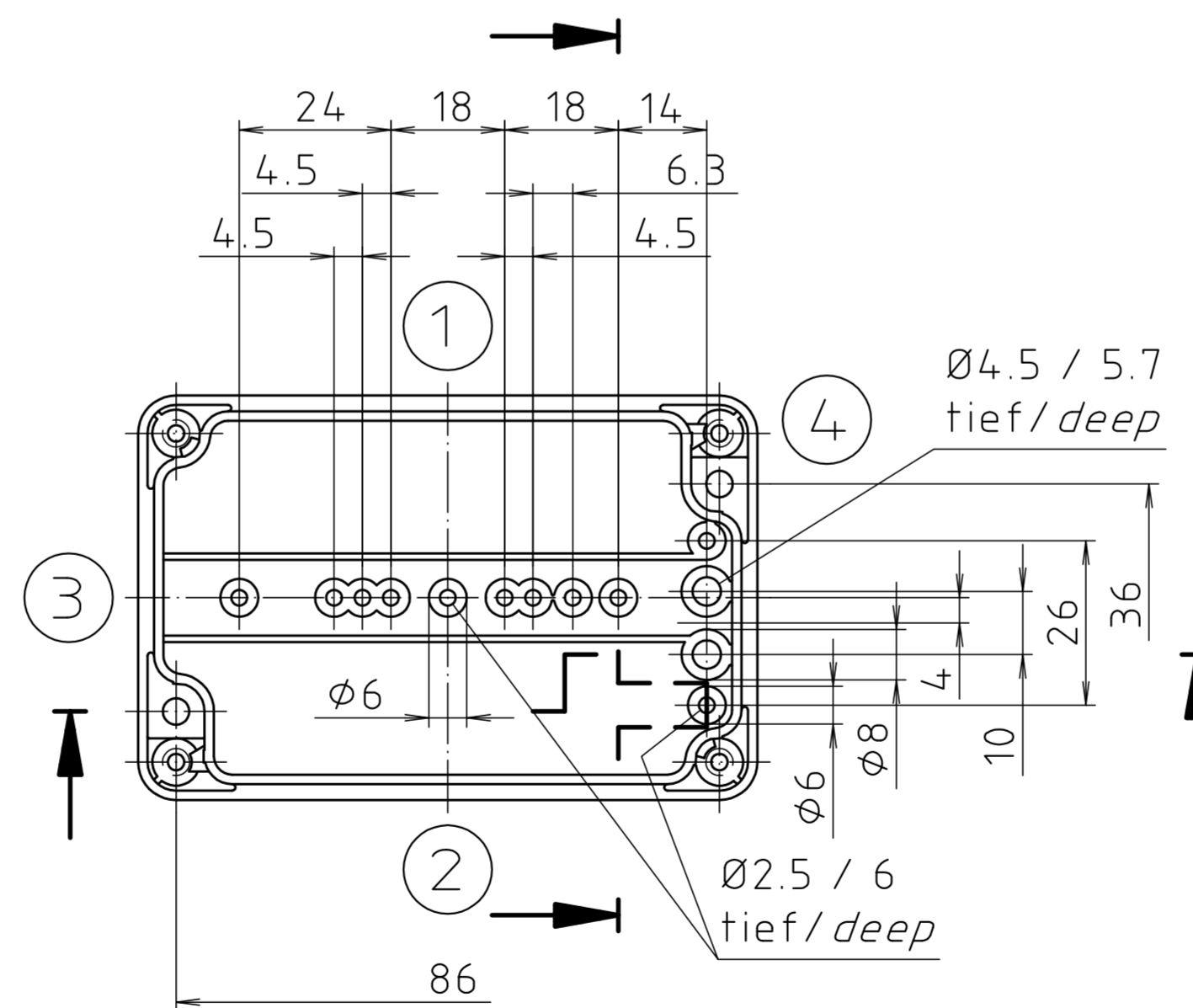
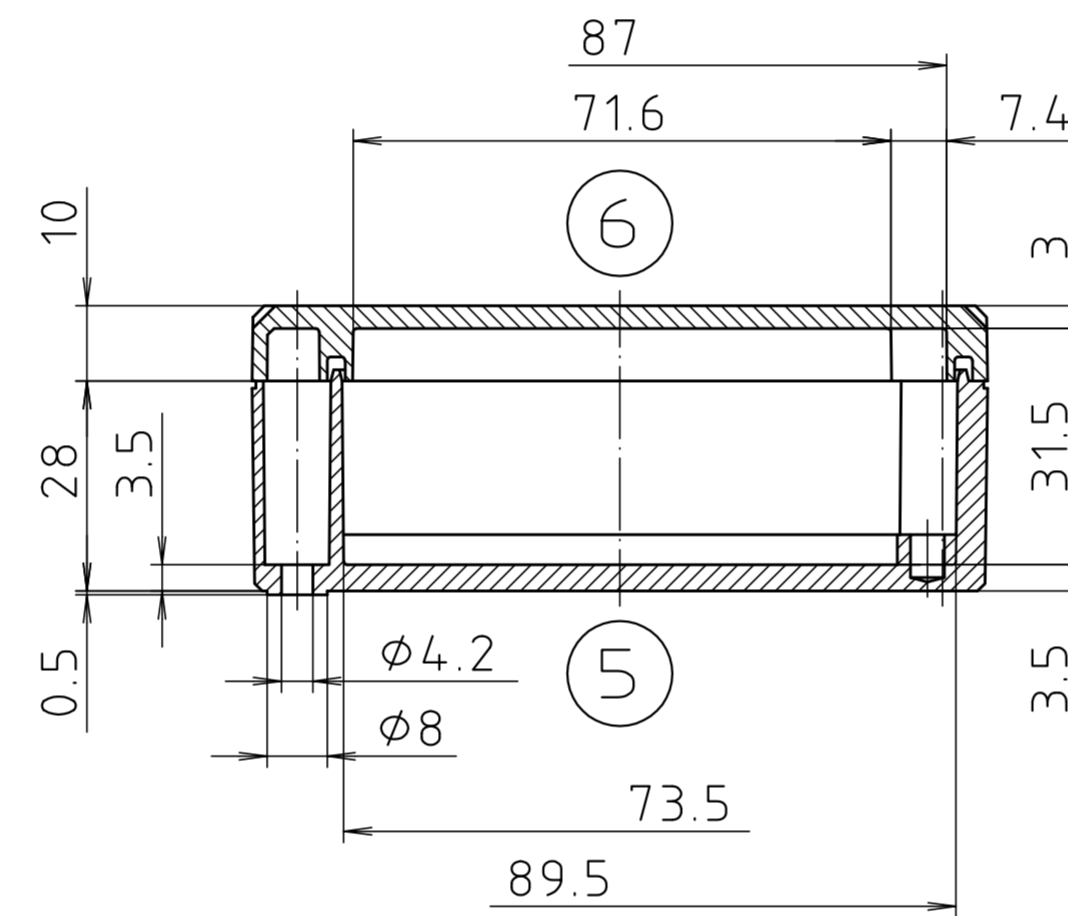
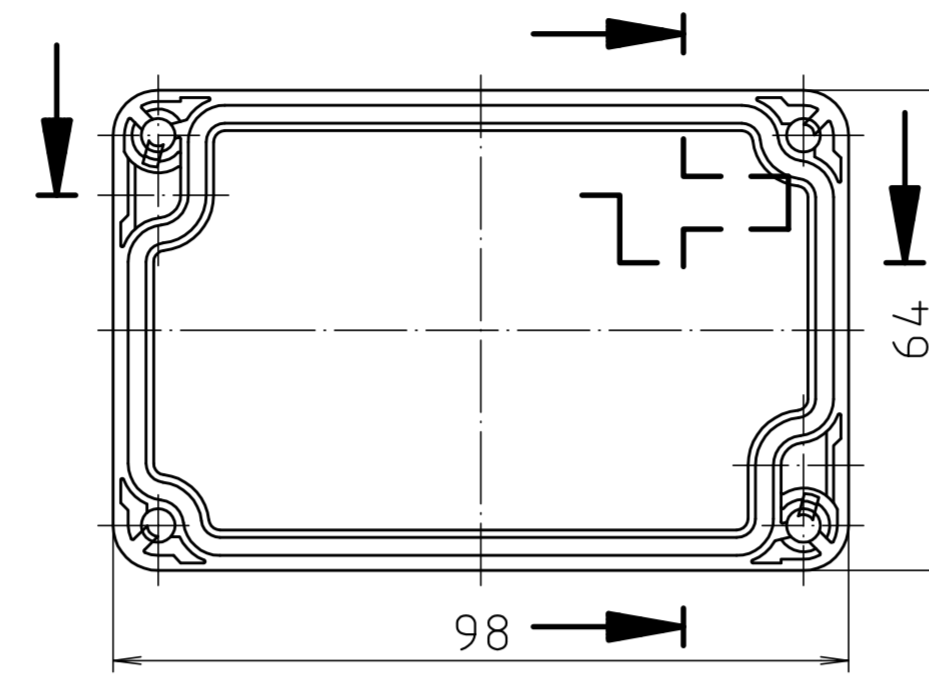
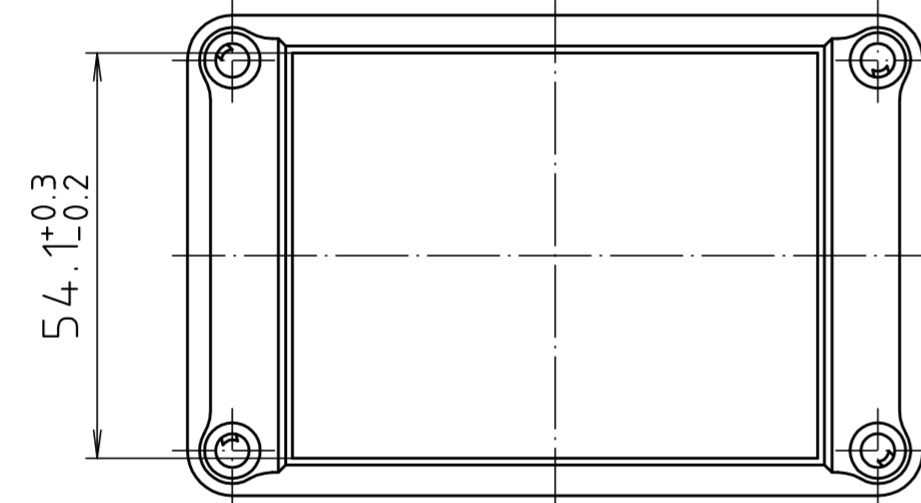
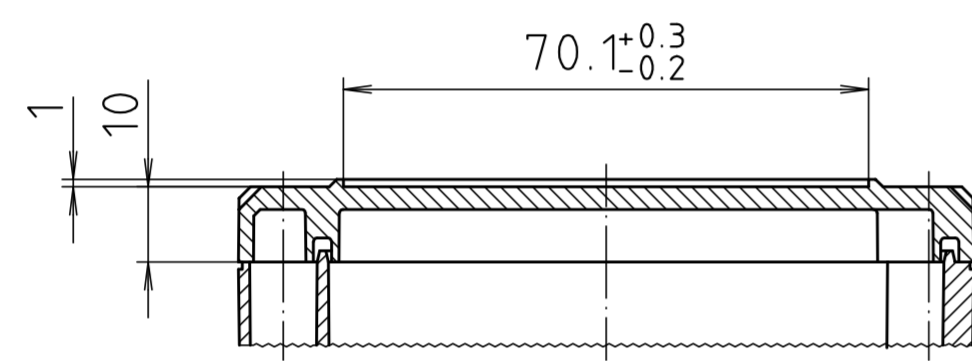

Maßstab/ Scale:	1:1	
Zeichnungs-Nr. / Drawing-No.:	1G 5145.029.04	
Artikel / Article:	EM/ET 208 EM/ET 208 F Katalogzeichnung/Catalogue drawing	
A.Nr./ Att.-No.:	Datum/ Date:	
2633	22.08.02	
2785	01.03.93	
2742	08.01.93	
DISK:	2 500 875	
Datum/Date:	02.07.92	OK