

Oberteil von Außen
lid from the outside

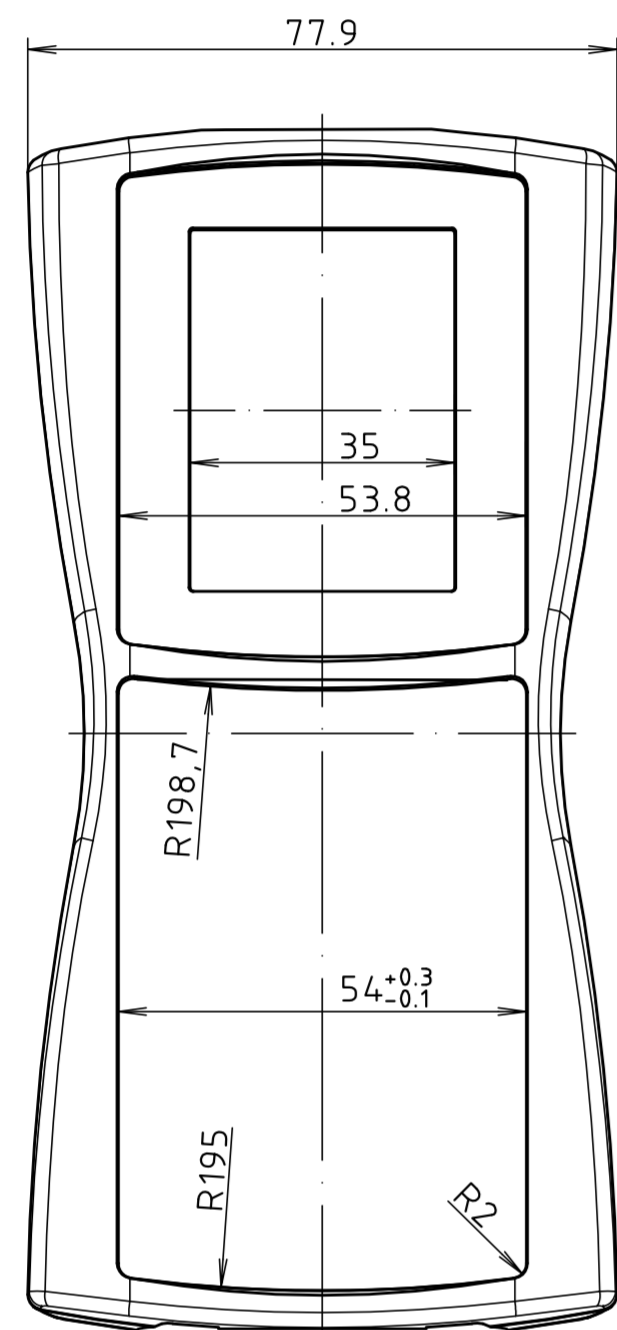

Unterteil von Innen
base from the inside

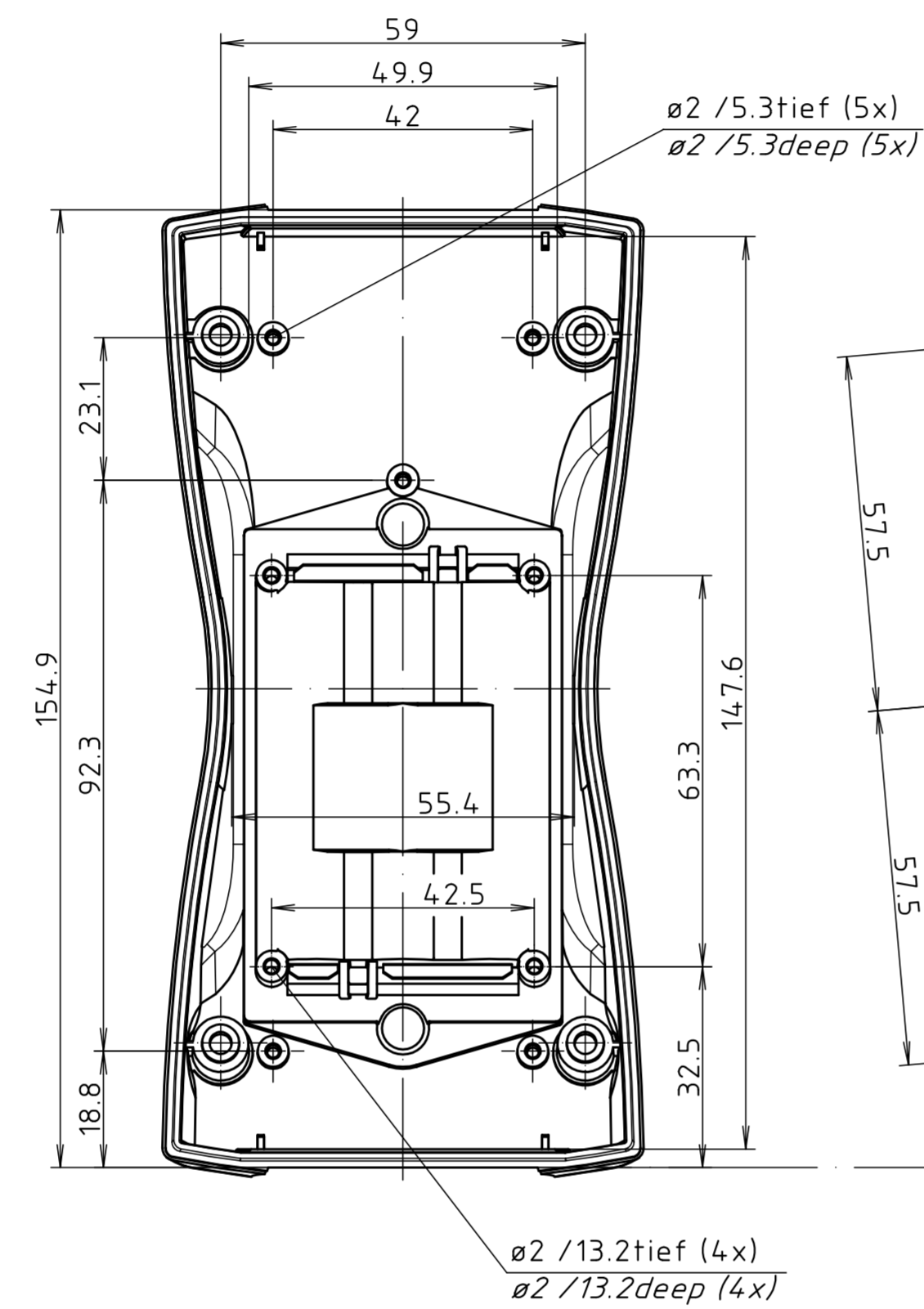

Oberteil von Innen
lid from the inside

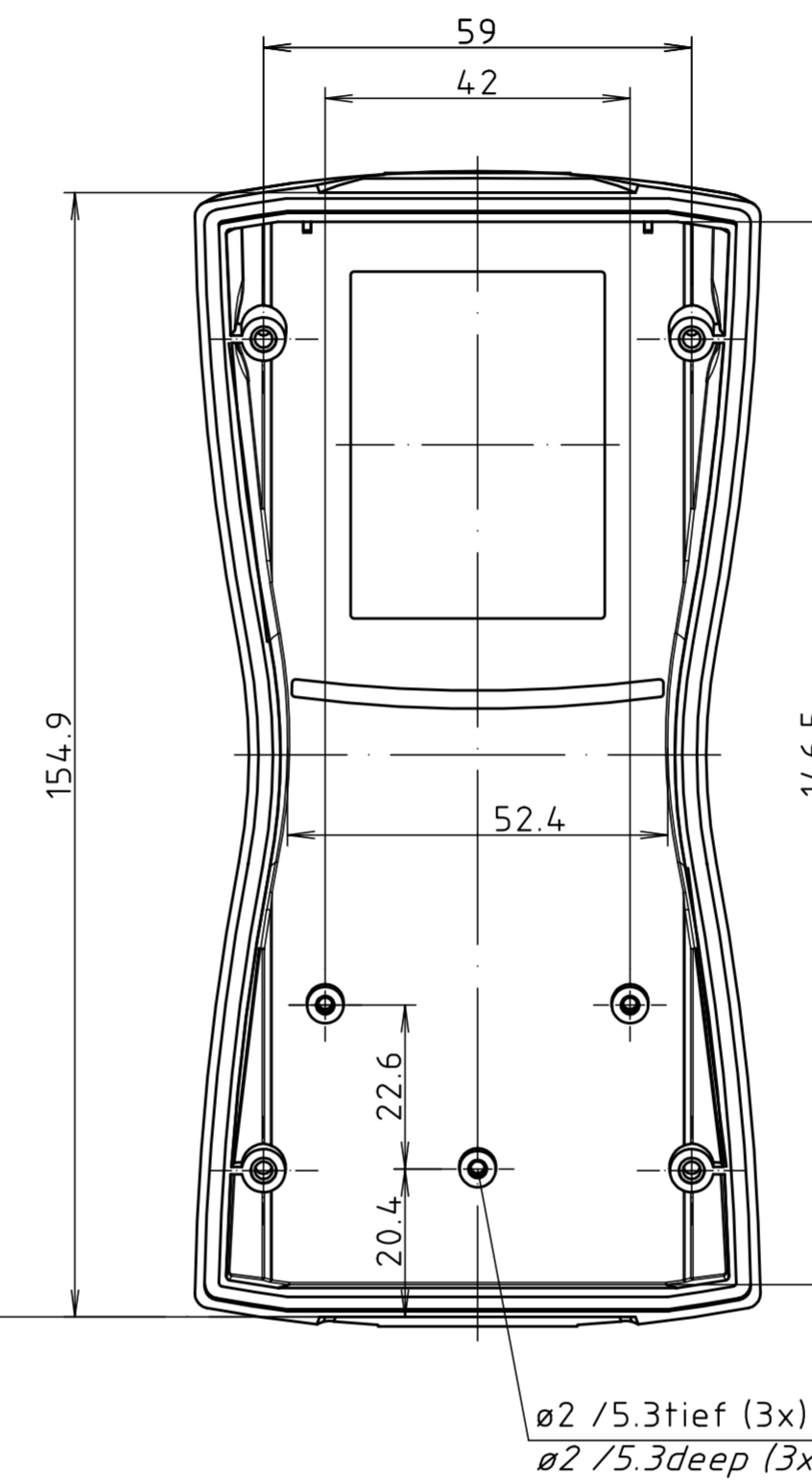

Unterteil von Außen
base from the outside

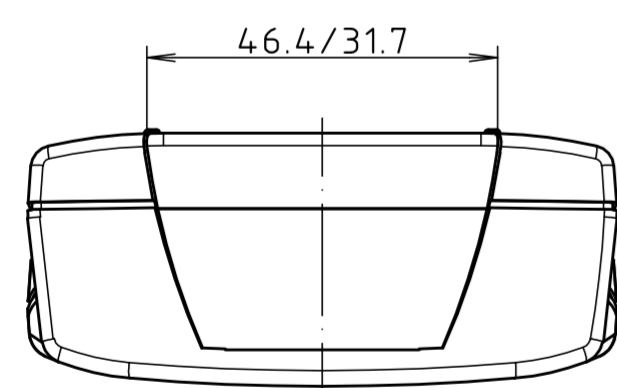
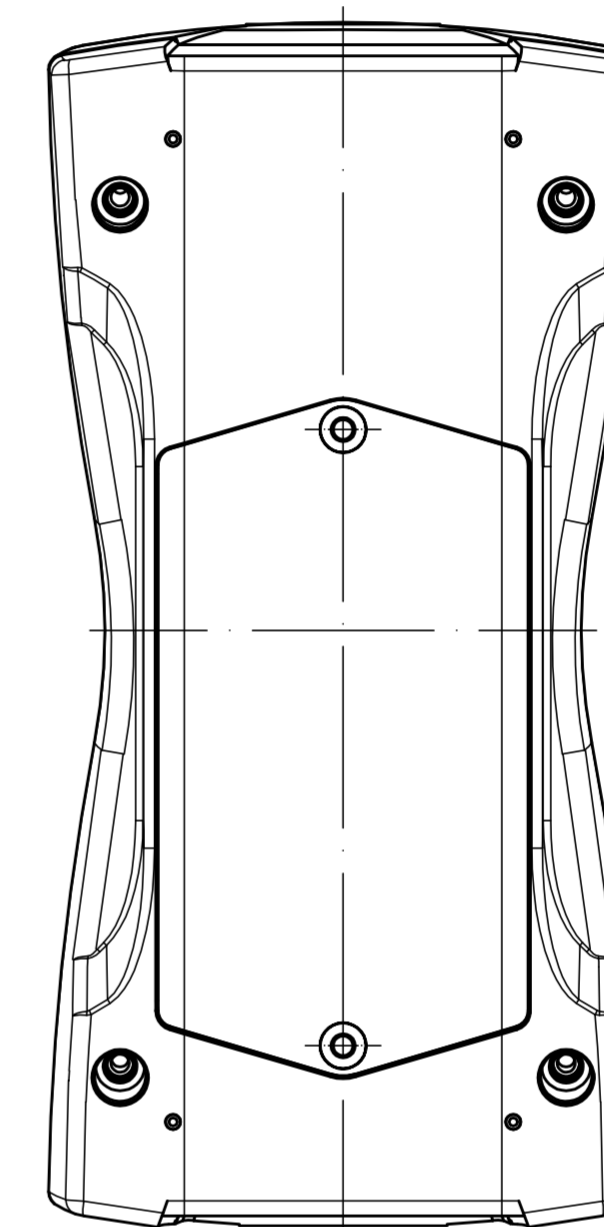

parallel montiert
parallel assembled

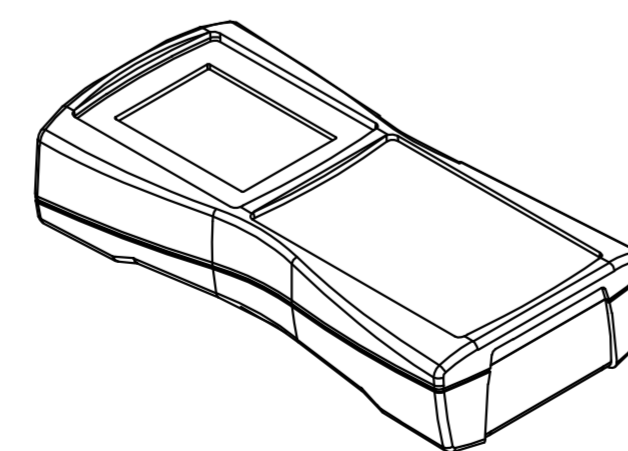

pultförmig montiert
inclined assembled

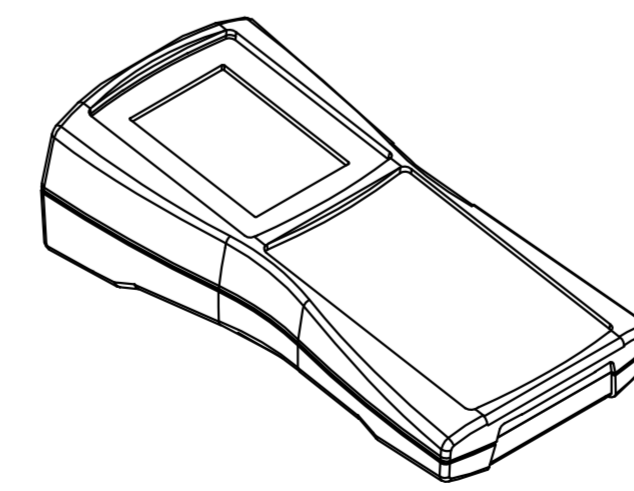

Modell / model	Ausführung / version
BS 601 DIS	IP 40, nicht aufrüstbar auf IP 65 (Batteriefach ohne Dichtung) IP 40, not upgradable to IP 65 (battery compartment without cord seal)
BS 603 DIS	IP 40, aufrüstbar auf IP 65 mit BS 600 DI-D (Batteriefach mit Rundschnurdichtung)/ IP 40, upgradable to IP 65 by fitting BS 600 DI-D (battery compartment with cord seal)
BS 604 DIS	IP 65 durch integrierte Rundschnurdichtungen, (keine Verwendung mit BS 600 DI-D möglich) IP 65 with integrated cord seal. (Use of BS 600 DI-D is not possible)

Maßstab / Scale: 1:1

Zeichnungs-Nr. / Drawing-No.: 1K 5355.035.02

Artikel / Article: BS 601 / 603 / 604 DIS
Katalogzeichnung / Catalogue drawing

9930 02.02.2010
A-Nr./ Datum / Alt.-No./ Date:
DISK: 2 802 686
Datum/Date: 11.05.06 KH