

"Schutzvermerk nach DIN ISO 16816 beachten" - "Please pay attention to copyright note DIN ISO 16816"

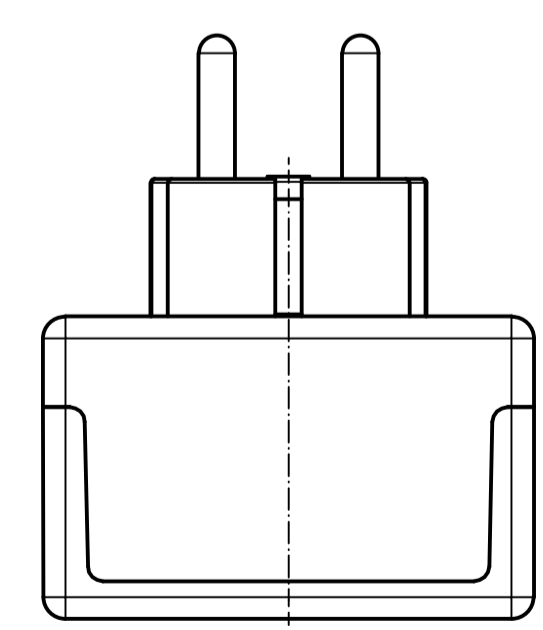

Unterteil von innen/
Base from the inside

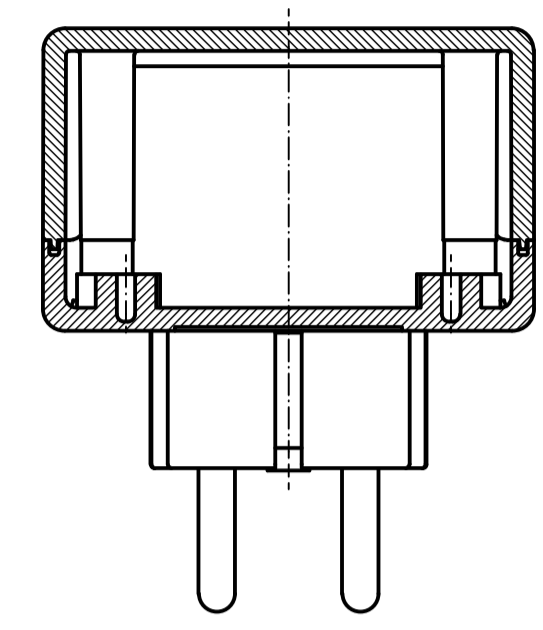
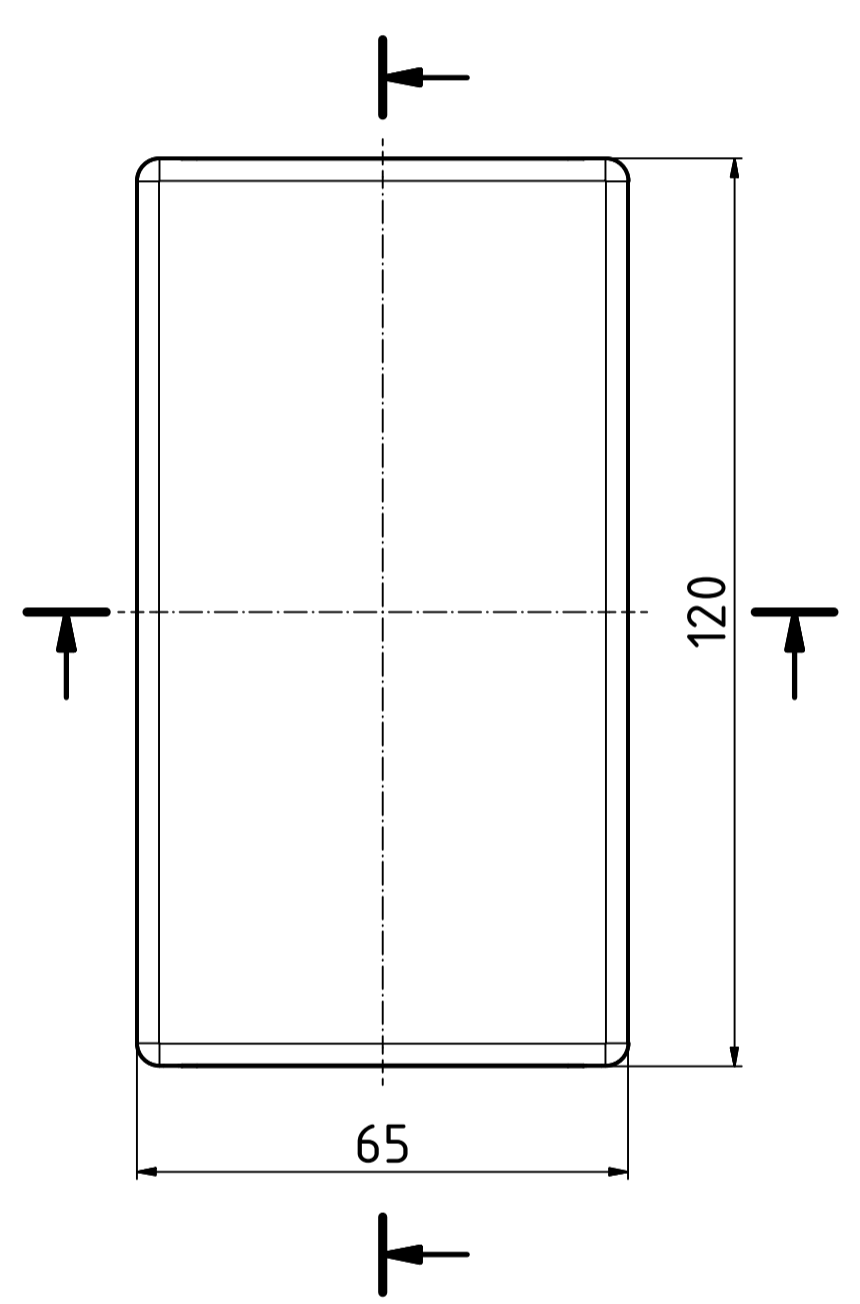
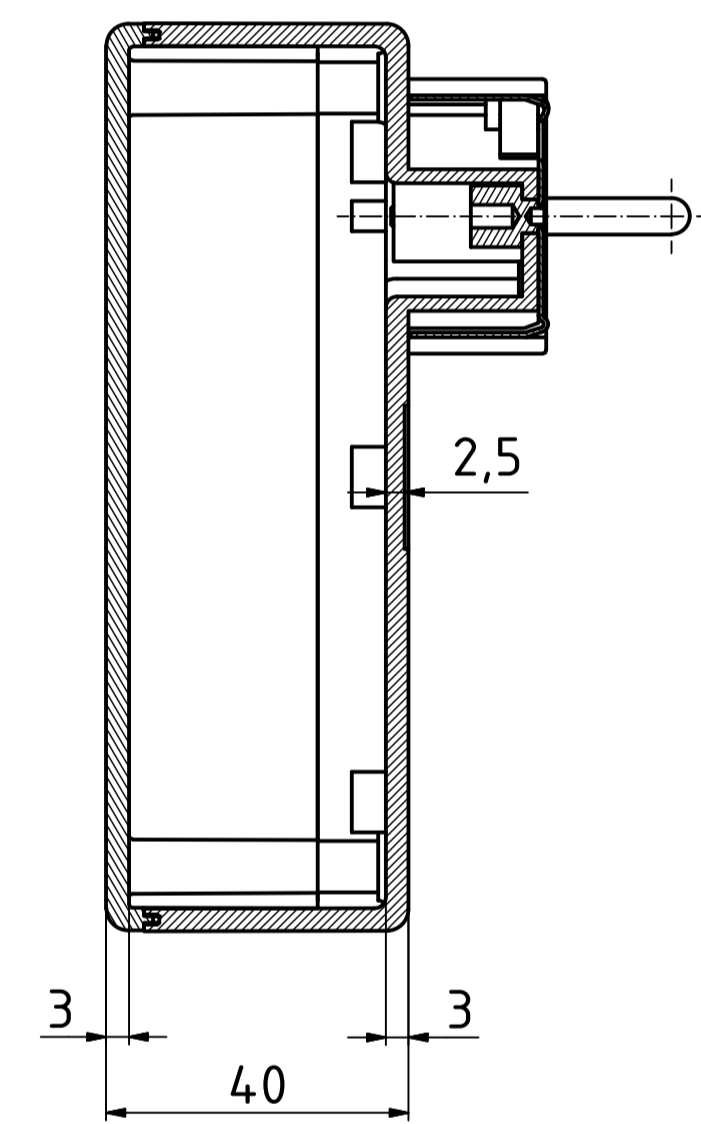
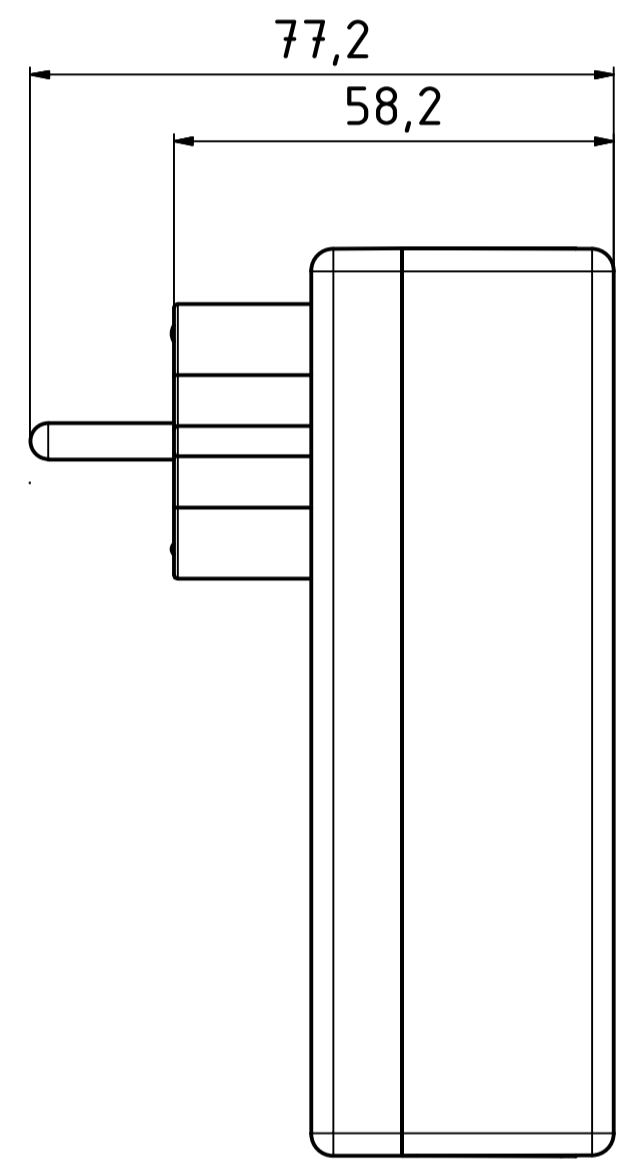
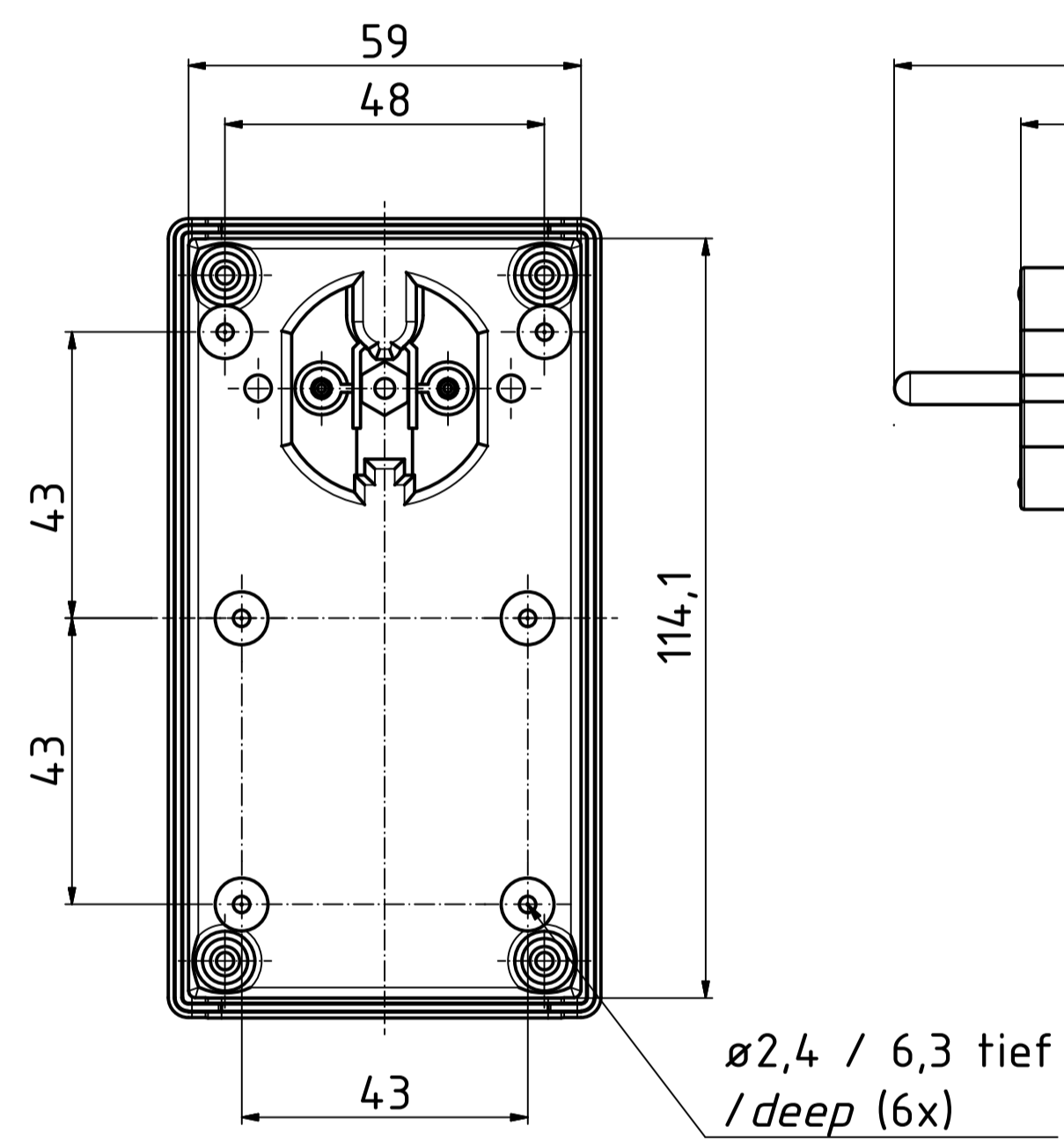

Oberteil von innen/
Lid from the inside

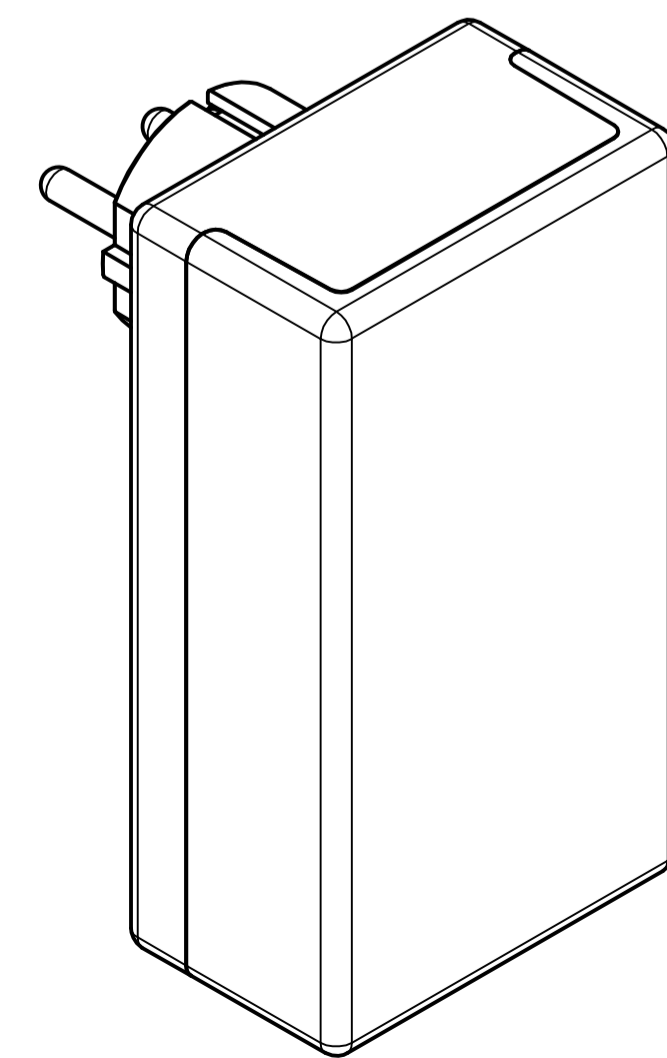
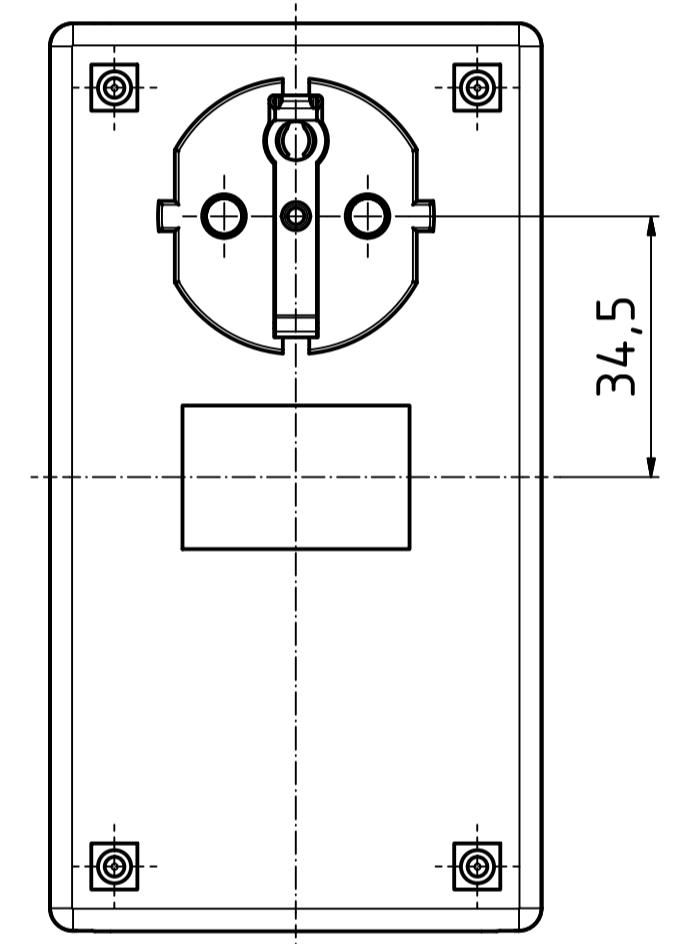
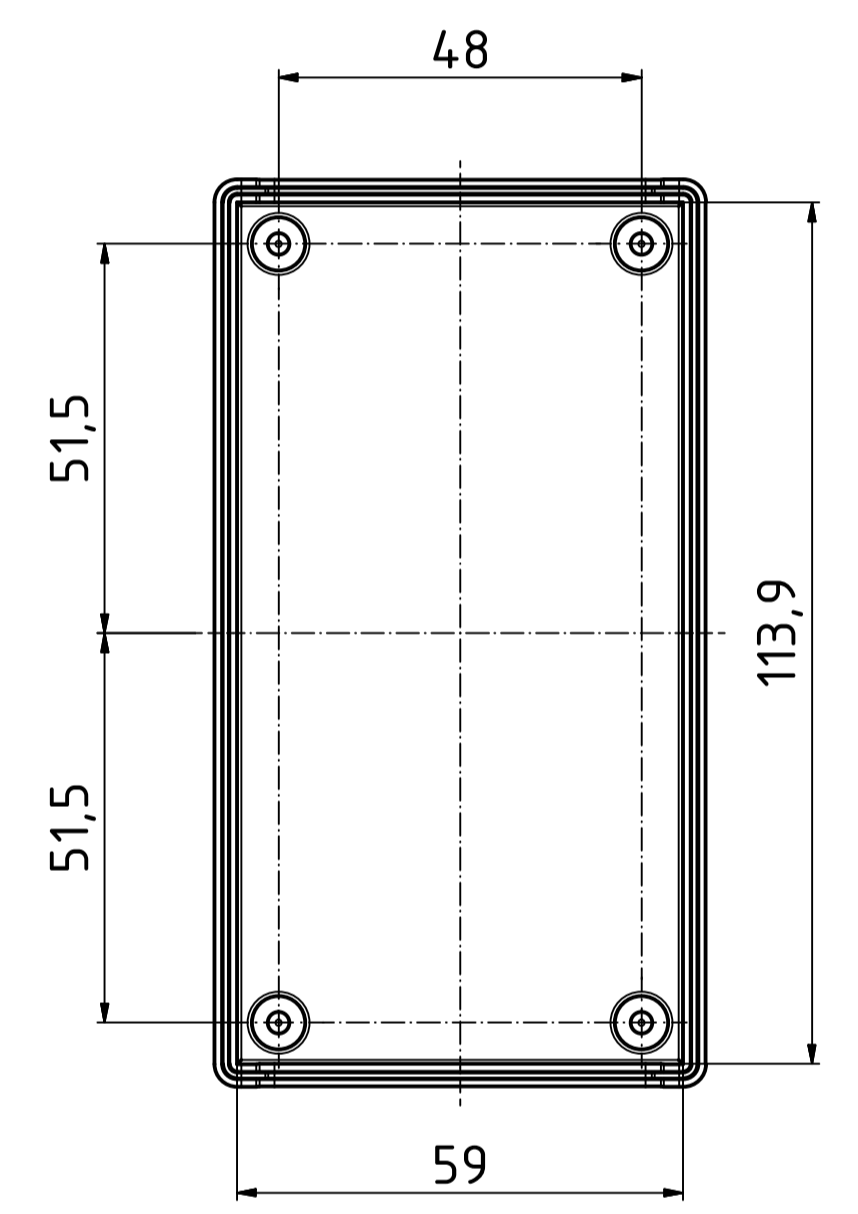

Maßstab/ Scale:	1:1	
Zeichnungs-Nr. / Drawing-No.:	1K 04.30.032.01	
Artikel / Article:	SE 430 E/CEE	
Katalogzeichnung/Catalogue drawing		
A.Nr./ Alt.No.:	Datum/ Date:	
DISK: 2803757.idw Datum/Date: 11.03.2015 CK		

