

RIGOL

User's Guide

DG1000Z Series Function/Arbitrary Waveform Generator

**Jul. 2015
RIGOL Technologies, Inc.**

Guaranty and Declaration

Copyright

© 2013 RIGOL Technologies, Inc. All Rights Reserved.

Trademark Information

RIGOL is a registered trademark of **RIGOL** Technologies, Inc.

Publication Number

UGB09106-1110

Notices

- **RIGOL** products are protected by patent law in and outside of P.R.C.
- **RIGOL** reserves the right to modify or change parts of or all the specifications and pricing policies at company's sole decision.
- Information in this publication replaces all previously corresponding material.
- **RIGOL** shall not be liable for losses caused by either incidental or consequential in connection with the furnishing, use or performance of this manual as well as any information contained.
- Any part of this document is forbidden to be copied or photocopied or rearranged without prior written approval of **RIGOL**.

Product Certification

RIGOL guarantees this product conforms to the national and industrial standards in China as well as the ISO9001:2008 standard and the ISO14001:2004 standard. Other international standard conformance certification is in progress.

Contact Us

If you have any problem or requirement when using our products or this manual, please contact **RIGOL**.

E-mail: service@rigol.com

Websites: www.rigol.com

Safety Requirement

General Safety Summary

Please review the following safety precautions carefully before putting the instrument into operation so as to avoid any personal injury or damage to the instrument and any product connected to it. To prevent potential hazards, please use the instrument only specified by this manual.

Use Proper Power Cord.

Only the power cord designed for the instrument and authorized for use within the local country could be used.

Ground The Instrument.

The instrument is grounded through the Protective Earth lead of the power cord. To avoid electric shock, it is essential to connect the earth terminal of power cord to the Protective Earth terminal before any inputs or outputs.

Connect the Probe Correctly.

If a probe is used, do not connect the ground lead to high voltage since it has the isobaric electric potential as ground.

Observe All Terminal Ratings.

To avoid fire or shock hazard, observe all ratings and markers on the instrument and check your manual for more information about ratings before connecting.

Use Proper Overvoltage Protection.

Make sure that no overvoltage (such as that caused by a thunderstorm) can reach the product, or else the operator might expose to danger of electrical shock.

Do Not Operate Without Covers.

Do not operate the instrument with

covers or panels removed.

Do Not Insert Anything into the Holes of Fan.

Do not insert anything into the holes of the fan to avoid damaging the instrument.

Use Proper Fuse.

Please use the specified fuses.

Avoid Circuit or Wire Exposure.

Do not touch exposed junctions and components when the unit is powered.

Do Not Operate With Suspected Failures.

If you suspect damage occurs to the instrument, have it inspected by qualified service personnel before further operations. Any maintenance, adjustment or replacement especially to circuits or accessories must be performed by **RIGOL** authorized personnel.

Keep Well Ventilation.

Inadequate ventilation may cause increasing of temperature or damages to the device. So please keep well ventilated and inspect the intake and fan regularly.

Do Not Operate in Wet Conditions.

In order to avoid short circuiting to the

interior of the device or electric shock, please do not operate in a humid environment.

Do Not Operate in an Explosive Atmosphere.

In order to avoid damages to the device or personal injuries, it is important to operate the device away from an explosive atmosphere.

Keep Product Surfaces Clean and Dry.

To avoid the influence of dust and/or moisture in air, please keep the surface of device clean and dry.

Electrostatic Prevention.

Operate in an electrostatic discharge protective area environment to avoid

damages induced by static discharges. Always ground both the internal and external conductors of the cable to release static before connecting.

Proper Use of Battery.

If a battery is supplied, it must not be exposed to high temperature or in contact with fire. Keep it out of the reach of children. Improper change of battery (note: lithium battery) may cause explosion. Use **RIGOL** specified battery only.

Handling Safety.

Please handle with care during transportation to avoid damages to buttons, knob interfaces and other parts on the panels.

Safety Terms and Symbols

Terms Used in this Manual. These terms may appear in this manual:



WARNING

Warning statements indicate the conditions or practices that could result in injury or loss of life.



CAUTION

Caution statements indicate the conditions or practices that could result in damage to this product or other property.

Terms Used on the Product. These terms may appear on the Product:

DANGER indicates an injury or hazard may immediately happen.

WARNING indicates an injury or hazard may be accessible potentially.

CAUTION indicates potential damage to the instrument or other property might occur.

Symbols Used on the Product. These symbols may appear on the product:



Hazardous Voltage



Safety Warning



Protective Earth Terminal



Chassis Ground



Test Ground

Allgemeine Sicherheits Informationen

Überprüfen Sie die folgenden Sicherheitshinweise sorgfältig um Personenschäden oder Schäden am Gerät und an damit verbundenen weiteren Geräten zu vermeiden. Zur Vermeidung von Gefahren, nutzen Sie bitte das Gerät nur so, wie in diesem Handbuch angegeben.

Um Feuer oder Verletzungen zu vermeiden, verwenden Sie ein ordnungsgemäßes Netzkabel

Verwenden Sie für dieses Gerät nur das für ihr Land zugelassene und genehmigte Netzkabel.

Erden des Gerätes

Das Gerät ist durch den Schutzleiter im Netzkabel geerdet. Um Gefahren durch elektrischen Schlag zu vermeiden, ist es unerlässlich, die Erdung durchzuführen. Erst dann dürfen weitere Ein- oder Ausgänge verbunden werden.

Anschluss eines Tastkopfes

Die Erdungsklemmen der Sonden sind auf dem gleichen Spannungspegel des Instruments geerdet. Schließen Sie die Erdungsklemmen an keine hohe Spannung an.

Beachten Sie alle Anschlüsse

Zur Vermeidung von Feuer oder Stromschlag, beachten Sie alle Bemerkungen und Markierungen auf dem Instrument. Befolgen Sie die Bedienungsanleitung für weitere Informationen, bevor Sie weitere Anschlüsse an das Instrument legen.

Verwenden Sie einen geeigneten Überspannungsschutz

Stellen Sie sicher, daß keinerlei Überspannung (wie z.B. durch Gewitter verursacht) das Gerät erreichen kann. Andernfalls besteht für den Anwender

die Gefahr eines Stromschlages.

Nicht ohne Abdeckung einschalten

Betreiben Sie das Gerät nicht mit entfernten Gehäuse-Abdeckungen.

Betreiben Sie das Gerät nicht geöffnet

Der Betrieb mit offenen oder entfernten Gehäuseteilen ist nicht zulässig. Nichts in entsprechende Öffnungen stecken (Lüfter z.B.)

Passende Sicherung verwenden

Setzen Sie nur die spezifikationsgemäßen Sicherungen ein.

Vermeiden Sie ungeschützte Verbindungen

Berühren Sie keine unisolierten Verbindungen oder Baugruppen, während das Gerät in Betrieb ist.

Betreiben Sie das Gerät nicht im Fehlerfall

Wenn Sie am Gerät einen Defekt vermuten, sorgen Sie dafür, bevor Sie das Gerät wieder betreiben, dass eine Untersuchung durch qualifiziertes Kundendienstpersonal durchgeführt wird. Jedwede Wartung, Einstellarbeiten oder Austausch von Teilen am Gerät, sowie am Zubehör dürfen nur von **RIGOL** autorisiertem Personal durchgeführt werden.

Belüftung sicherstellen

Unzureichende Belüftung kann zu Temperaturanstiegen und somit zu thermischen Schäden am Gerät führen. Stellen Sie deswegen die Belüftung sicher und kontrollieren regelmäßig Lüfter und Belüftungsöffnungen.

Nicht in feuchter Umgebung betreiben

Zur Vermeidung von Kurzschluß im Geräteinneren und Stromschlag betreiben Sie das Gerät bitte niemals in feuchter Umgebung.

Nicht in explosiver Atmosphäre betreiben

Zur Vermeidung von Personen- und Sachschäden ist es unumgänglich, das Gerät ausschließlich fernab jedweder explosiven Atmosphäre zu betreiben.

Geräteoberflächen sauber und trocken halten

Um den Einfluß von Staub und Feuchtigkeit aus der Luft auszuschließen, halten Sie bitte die Geräteoberflächen sauber und trocken.

Schutz gegen elektrostatische Entladung (ESD)

Sorgen Sie für eine elektrostatisch geschützte Umgebung, um somit Schäden und Funktionsstörungen durch ESD zu vermeiden. Erden Sie vor dem Anschluß immer Innen- und Außenleiter der Verbindungsleitung, um statische Aufladung zu entladen.

Die richtige Verwendung des Akkus.

Wenn eine Batterie verwendet wird, vermeiden Sie hohe Temperaturen bzw. Feuer ausgesetzt werden. Bewahren Sie es außerhalb der Reichweite von Kindern auf. Unsachgemäße Änderung der Batterie (Anmerkung: Lithium-Batterie) kann zu einer Explosion führen. Verwenden Sie nur von RIGOL angegebene Akkus.

Sicherer Transport

Transportieren Sie das Gerät sorgfältig (Verpackung!), um Schäden an Bedienelementen, Anschlüssen und anderen Teilen zu vermeiden.

Sicherheits Begriffe und Symbole

Begriffe in diesem Guide. Diese Begriffe können in diesem Handbuch auftauchen:



WARNING

Die Kennzeichnung WARNING beschreibt Gefahrenquellen die leibliche Schäden oder den Tod von Personen zur Folge haben können.



CAUTION

Die Kennzeichnung Caution (Vorsicht) beschreibt Gefahrenquellen die Schäden am Gerät hervorrufen können.

Begriffe auf dem Produkt. Diese Bedingungen können auf dem Produkt erscheinen:

DANGER (dt. GEFAHR)

weist auf eine Verletzung oder Gefährdung hin, die sofort geschehen kann.

WARNING (dt. WARNUNG)

weist auf eine Verletzung oder Gefährdung hin, die möglicherweise nicht sofort geschehen.

CAUTION (dt. VORSICHT)

bedeutet, dass eine mögliche Beschädigung des Instruments oder anderer Gegenstände auftreten kann.

Symbole auf dem Produkt. Diese Symbole können auf dem Produkt erscheinen:



**Gefährliches
pannung**



**Sicherheits-
Hinweis**



Schutz-erde



Gehäusemasse



Erde

General Care and Cleaning

General Care:

Do not store or leave the instrument in where the instrument will be exposed to direct sunlight for long periods of time.

Cleaning:

Clean the instrument regularly according to its operating conditions. To clean the exterior surface, perform the following steps:

1. Disconnect the instrument from all power sources.
2. Clean the loose dust on the outside of the instrument with a lint- free cloth (with a mild detergent or water). When cleaning the LCD, take care to avoid scarifying it.



CAUTION

To avoid damages to the instrument, do not expose them to liquids which have causticity.



WARNING

To avoid injury resulting from short circuit, make sure the instrument is completely dry before reconnecting to a power source.

Environmental Considerations

The following symbol indicates that this product complies with the requirements in WEEE Directive 2002/96/EC.



Product End-of-Life Handling

The equipment may contain substances that could be harmful to the environment or human health. In order to avoid release of such substances into the environment and harm to human health, we encourage you to recycle this product in an appropriate system that will ensure that most of the materials are reused or recycled appropriately. Please contact your local authorities for disposal or recycling information.

DG1000Z Series Overview

DG1000Z Series is a multifunctional generator that combines many functions in one, including Function Generator, Arbitrary Waveform Generator, Noise Generator, Pulse Generator, Harmonics Generator, Analog/Digital Modulator and Counter. As a multi-functional, high performance, high cost-effective and portable generator, it will be a new selection in education, R&D, production, test, etc.

Main Features:

- Maximum output frequency (Sine): 30MHz and 60MHz
- Innovative SiFi (Signal Fidelity): generate the arbitrary waveform point by point, undistortedly restore signal, precisely adjustable sample rate and low jitter (down to 200ps) for all waveforms including Square, Pulse and etc.
- Arbitrary waveform memory for each channel: 8Mpts (standard), 16Mpts (optional)
- Standard dual full functional channels which are equivalent to two independent generators
- ± 1 ppm frequency stability, -125dBc/Hz phase noise
- Built-in 8 orders harmonics generator
- Built-in 7 digits/s full function frequency counter with 200MHz bandwidth
- Up to 160 built-in waveforms encompassing common signals in various fields including Engineering, Medical Electronics, Automotive Electronics, Mathematics and etc.
- 200MSa/s sample rate, 14bits vertical resolution
- Standard powerful arbitrary waveform editing function. Users can also edit arbitrary waveform using PC software
- Various modulation functions: AM, FM, PM, ASK, FSK, PSK and PWM
- Standard waveform summing function. When it is enabled, you can superpose specified waveform onto basic waveform before output
- Standard channel tracking function. When it is enabled, all parameters of dual channels can be modified synchronously according to user's requirements
- Standard interfaces: USB Host, USB Device, LAN (LXI Core Device 2011)
- 3.5 inches (320*240) color display
- Portable design, only weight 3.5kg

Document Overview

Subjects in this Manual

Chapter 1 Quick Start	Briefly introduces the appearance and dimensions, front/rear panel and user interface of DG1000Z.
Chapter 2 Front Panel Operations	Introduce the main functions and operation methods of DG1000Z.
Chapter 3 Remote Control	Briefly introduce how to control the DG1000Z remotely.
Chapter 4 Troubleshooting	List the possible failures or problems and their solutions when using DG1000Z.
Chapter 5 Specifications	Provide the specifications of DG1000Z series.
Chapter 6 Appendix	Provide the information about the options and accessories list as well as warranty information of DG1000Z.

Format Conventions in this Manual

1. Button:

The button at the front panel is denoted by the format of "Text Box + Button Name (Bold)" in the manual, for example, **Sine**.

2. Menu:

The menu is denoted by the format of "Character Shading + Menu Word (Bold)" in the manual, for example, **Freq**.

3. Connector:

The connector at the front or rear panel is denoted by the format of "Square Brackets+Connector Name (Bold)" in the manual, for example, **[Counter]**.

4. Operation Steps:

The next step of the operation is denoted by an arrow "→" in the manual. For example, **Sine** → **Freq** represents pressing **Sine** at the front panel and then pressing **Freq**.

Content Conventions in this Manual

1. DG1000Z series function/arbitrary waveform generator includes DG1032Z and DG1062Z. In this manual, DG1062Z is taken as an example to introduce the operating method of the generator.

Model	Channels	Max. Frequency
DG1062Z	2	60MHz
DG1032Z	2	30MHz

2. Both models of DG1000Z series function/arbitrary waveform generator are equipped with dual channels (CH1 and CH2). Unless otherwise specified, this manual takes CH1 as an example to introduce the operation methods which are also applied to CH2.

Manuals of this Product

The manuals of this product mainly include the quick guide, user's guide, programming guide and data sheet. For the newest version of the desired manual, download it from the **RIGOL** website (www.rigol.com).

Contents

Guaranty and Declaration	I
Safety Requirement	II
General Safety Summary	II
Safety Terms and Symbols	IV
Allgemeine Sicherheits Informationen	V
Sicherheits Begriffe und Symbole	VII
General Care and Cleaning	VIII
Environmental Considerations	IX
DG1000Z Series Overview	X
Document Overview	XI
Chapter 1 Quick Start	1-1
General Inspection	1-2
To Adjust the Handle	1-3
Appearance and Dimensions	1-4
Front Panel Overview	1-5
Rear Panel Overview	1-11
Power On and Inspection	1-14
To Connect to Power	1-14
Power-on	1-14
To Set the System Language	1-15
User Interface	1-16
Dual Channels Parameters Mode	1-16
Dual Channels Graph Mode	1-19
Single Channel View Mode	1-19
To Use the Built-in Help System	1-20
Rack Mount Kit Installation (Option)	1-21
To Install Single Instrument	1-21
To Install Dual Instruments	1-26
Chapter 2 Front Panel Operations	2-1
To Output Basic Waveform	2-2
To Select Output Channel	2-2
To Select Basic Waveform	2-3
To Set Frequency/Period	2-4
To Set Amplitude/High Level	2-5
To Set Offset/Low Level	2-7
To Set Start Phase	2-8
Align Phase	2-9
To Set Duty Cycle (Square)	2-10
To Set Symmetry (Ramp)	2-11
To Set Pulse Width/Duty Cycle (Pulse)	2-12

To Set Leading/Trailing Edge Time (Pulse).....	2-13
To Enable Output.....	2-14
Example: To Output Sine Waveform	2-15
To Output Arbitrary Waveform.....	2-17
To Enable Arbitrary Waveform.....	2-17
Output Mode and Sample Rate	2-18
To Select Arbitrary Waveform.....	2-19
To Edit Arbitrary Waveform.....	2-26
To Output Harmonic	2-30
Overview	2-30
To Set Fundamental Waveform Parameters	2-31
To Set Harmonic Order.....	2-31
To Select Harmonic Type	2-31
To Set Harmonic Amplitude.....	2-32
To Set Harmonic Phase	2-32
Example: To Output Harmonic	2-33
Modulation	2-35
Amplitude Modulation (AM)	2-35
Frequency Modulation (FM)	2-39
Phase Modulation (PM)	2-42
Amplitude Shift Keying (ASK)	2-45
Frequency Shift Keying (FSK).....	2-48
Phase Shift Keying (PSK)	2-51
Pulse Width Modulation (PWM)	2-54
Sweep.....	2-57
To Enable Sweep Function.....	2-57
Start Frequency and Stop Frequency	2-57
Center Frequency and Frequency Span.....	2-58
Sweep Type	2-59
Sweep Time	2-60
Return Time.....	2-60
Mark Frequency.....	2-61
Start Hold	2-61
Stop Hold	2-62
Sweep Trigger Source	2-62
Burst	2-65
To Enable Burst Function.....	2-65
Burst Type	2-65
Burst Period	2-67
Gated Polarity	2-67
Burst Delay.....	2-68
Burst Trigger Source	2-68
Counter.....	2-70
To Enable the Counter.....	2-70
To Set the Counter.....	2-71
Store and Recall.....	2-74

Storage System	2-74
File Type	2-75
Browser Type	2-77
File Operation.....	2-77
Seamless Interconnection with Oscilloscope	2-81
Utility and System Settings.....	2-83
Channel Set.....	2-84
Coupling Set.....	2-90
Channel Copy	2-93
Restore Default.....	2-94
To Set System Language	2-99
System Information.....	2-99
System Set.....	2-100
I/O Configuration.....	2-103
Print Set	2-108
Test/Calibration.....	2-108
To Use External Power Amplifier (Option)	2-109
Chapter 3 Remote Control	3-1
Remote Control via USB	3-2
Remote Control via LAN	3-5
Remote Control via GPIB (Option)	3-8
Chapter 4 Troubleshooting	4-1
Chapter 5 Specifications	5-1
Chapter 6 Appendix	6-1
Appendix A: Accessories and Options	6-1
Appendix B: Specifications of Power Amplifier	6-2
Appendix C: Warranty	6-4
Index	1

Chapter 1 Quick Start

This chapter briefly introduces the appearance and dimensions, front/rear panel and user interface of DG1000Z as well as how to install the instrument into standard cabinet.

Subjects in this chapter:

- General Inspection
- To Adjust the Handle
- Appearance and Dimensions
- Front Panel Overview
- Rear Panel Overview
- Power On and Inspection
- User Interface
- To Use the Built-in Help System
- Rack Mount Kit Installation (Option)

General Inspection

1. **Inspect the shipping container for damage.**

Keep the damaged shipping container or cushioning material until the contents of the shipment have been checked for completeness and the instrument has passed both electrical and mechanical test.

The consigner or carrier shall be liable for the damage to instrument resulting from shipment. **RIGOL** would not be responsible for free maintenance/rework or replacement of the unit.

2. **Inspect the instrument.**

In case of any mechanical damage or defect, or if the instrument does not operate properly or pass the electrical and mechanical tests, contact your local sales representative of RIGOL.

3. **Check the accessories.**

Please check the accessories according to the packing lists. If the accessories are incomplete or damaged, please contact your **RIGOL** sales representative.

To Adjust the Handle

To adjust the handle, please hold the handle by sides of the instrument and pull it outward, and then rotate the handle to the desired position (as shown in the figure below).

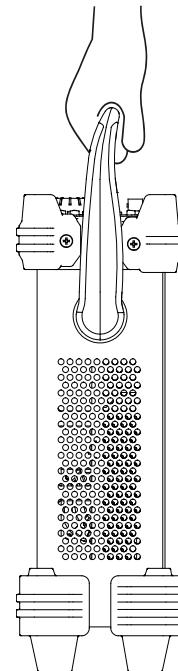
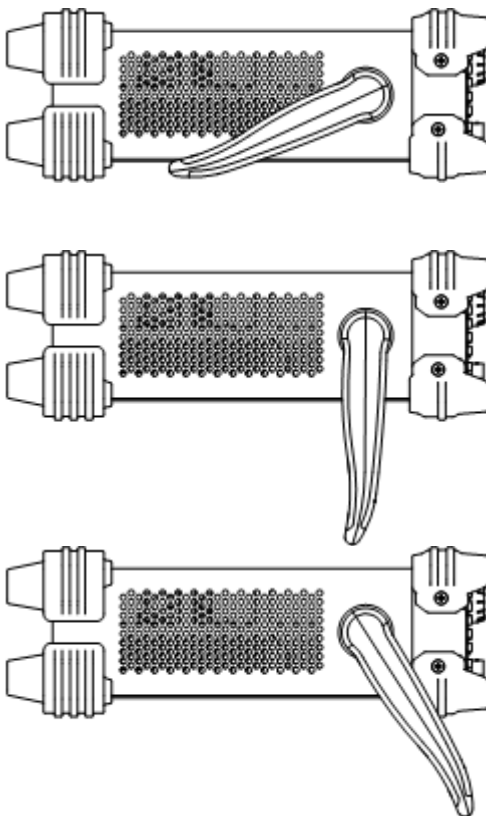
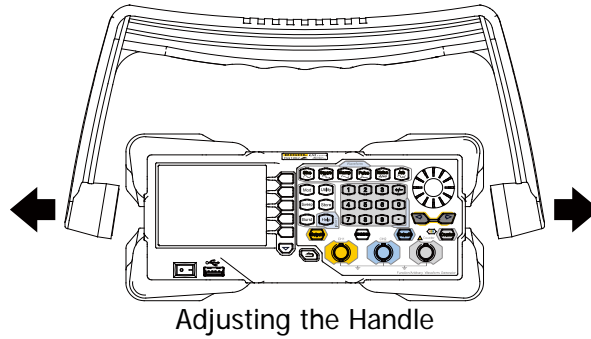

Appearance and Dimensions

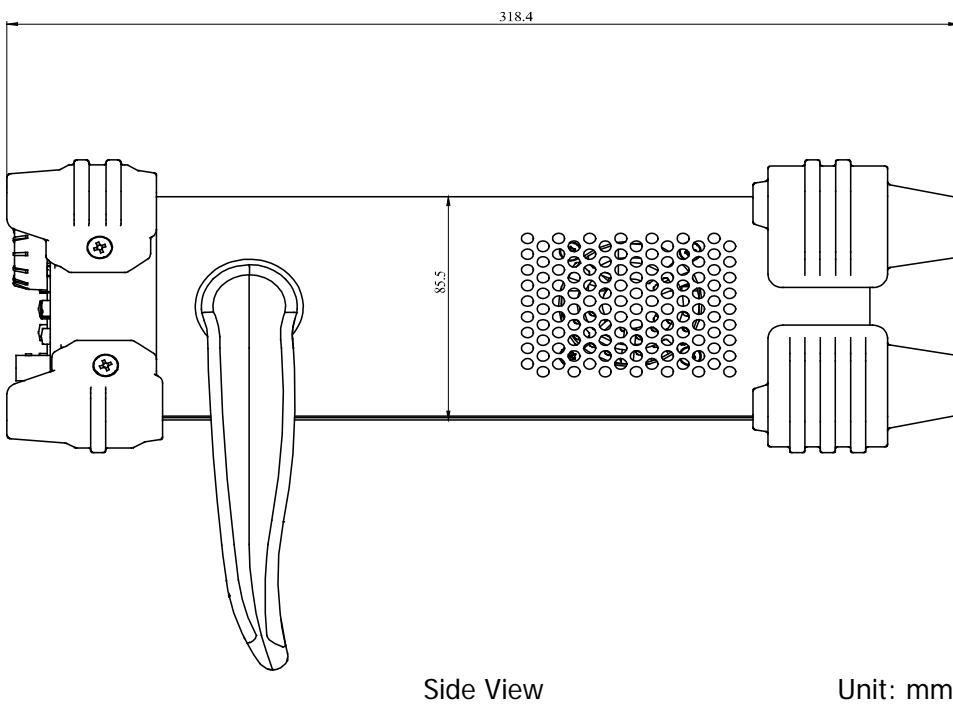
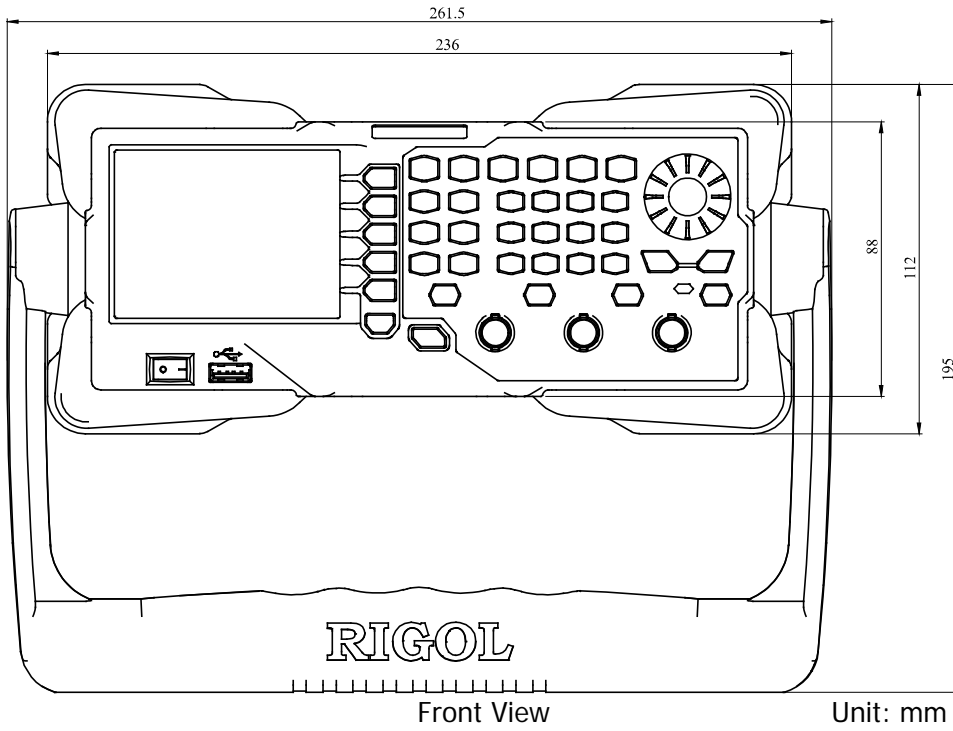

Front Panel Overview

The front panel of DG1000Z is shown below. Click the numbers in the figure to view the corresponding description.

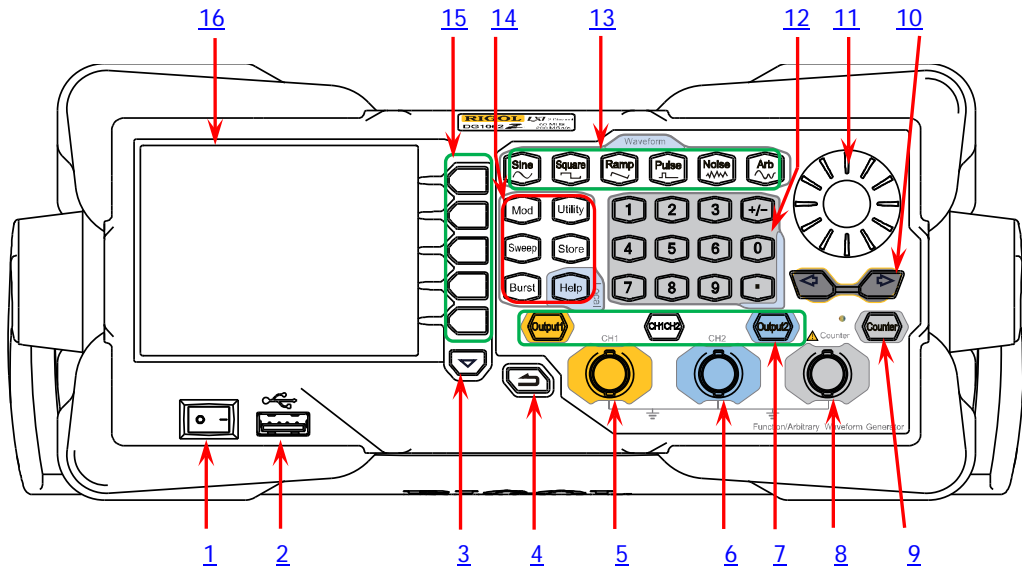

Figure 1-1 Front Panel

1. Power Key

The power key is used to turn the generator on or off.

2. USB Host

Support USB storage device, **RIGOL** TMC digital oscilloscope (DS), power amplifier (PA) and USB to GPIB interface converter (Option).

- USB storage device: read the waveform or state files saved in the USB storage device or store the current instrument states or edited waveform data into the USB storage device. In additional, the content displayed on the screen also can be saved as a picture file (*.Bmp) into the USB storage device.
- TMC DS: seamlessly interconnect with the **RIGOL** DS that meets the TMC standard. Read and store the waveform data collected by the DS and rebuilt waveform losslessly.
- PA (option): support the **RIGOL** power amplifier (such as PA1011). You can configure it online and the signal is outputted after whose power is amplified.
- USB to GPIB interface converter (Option): expand the GPIB interface for **RIGOL** instrument with USB Host interface but without GPIB interface.

3. Page Up/Down

Open the next page of the current function menu or return to the first page.

4. Return to the Previous Menu

Exit the current menu and return to the previous menu.

5. CH1 Output Connector

BNC connector with 50Ω nominal output impedance.

When **Output1** is enabled (the backlight turns on), this connector outputs waveform according to the current configuration of CH1.

6. CH2 Output Connector

BNC connector with 50Ω nominal output impedance.

When **Output2** is enabled (the backlight turns on), this connector outputs waveform according to the current configuration of CH2.

7. Channels Control Area



It is used to control the output of CH1.

- Press this key to open the output of CH1, the backlight turns on and the **[CH1]** connector outputs the waveform according to the current configuration of CH1.
- Press this key again to close the output of CH1 and the backlight turns off.



It is used to control the output of CH2.

- Press this key to open the output of CH2, the backlight turns on and the **[CH2]** connector outputs the waveform according to the current configuration of CH2.
- Press this key again to close the output of CH2 and the backlight turns off.



It is used to switch the current selected channel between CH1 and CH2.



CAUTION

Overvoltage protection of the output channels of CH1 and CH2 will take effect once any of the following conditions is met. When the overvoltage protection takes effect, the prompt message will be displayed on the screen and the output will be disabled.

- The amplitude setting in the generator is greater than 2Vpp or the output offset is greater than $|2V_{DC}|$, the input voltage is greater than $\pm 11.5 \times (1 \pm 5\%)V$ ($< 10\text{kHz}$).
- The amplitude setting in the generator is lower than or equal to 2Vpp or the output offset is lower than or equal to $|2V_{DC}|$, the input voltage is greater than $\pm 3.5 \times (1 \pm 5\%)V$ ($< 10\text{kHz}$).

8. Input Connector for the Signal Measured by Counter

BNC connector with 1M Ω input impedance. It is used to accept the signal measured by the counter.



CAUTION

To avoid damages to the instrument, the input signal voltage can not exceed $\pm 7V_{ac+dc}$.

9. Counter

It is used to turn the counter on or off.

- Press this key to turn the counter on, the backlight turns on and the indicator at the left of **Counter** blinks.
- Press this key again to turn the counter off and the backlight turns off.

Note: the sync signal of CH2 will be disabled if the counter is turned on and it will be enabled after the counter is turned off.

10. Direction Keys

- Used to move the cursor to select the digit to be edited when setting parameter using knob.
- Used to delete the number at the left of the cursor when inputting parameter using numeric keyboard.
- Used to unfold or fold the current selected directory when storing or reading file.
- Used to move the cursor to select the specified character in filename input area when editing filename.

11. Knob

- Used to increase (clockwise) or decrease (counterclockwise) the value marked by the cursor when setting parameter using knob.
- Used to select the storage location when storing a file or used to select the file to be read when reading file.
- Used to select a character from the virtual keyboard when editing filename.
- Used to select a desired built-in arbitrary waveform from **Arb** → **Select Wform** → **BuiltIn**.

12. Numeric Keyboard

It consists of numbers (0 to 9), decimal point (.), sign key (+/-) and is used to set parameters.

Note:

- 1) The sign key is used to switch between uppercase and lowercase when editing filename.
- 2) Use the decimal point key to quickly save the content displayed in the user interface in the USB storage device in *.Bmp format (for the detailed steps, please refer to "Print Set").

13. Waveforms Key



Output Sine with frequency from 1 μ Hz to 60MHz.

- The backlight turns on when this function is selected.
- You can set Freq/Period, Ampl/HiLevel, Offset/LoLevel and Start Phase of sine waveform.



Output Square with frequency from 1 μ Hz to 25MHz and variable duty cycle.

- The backlight turns on when this function is selected.
- You can set Freq/Period, Ampl/HiLevel, Offset/LoLevel, Duty Cycle and Start Phase of square waveform.



Output Ramp with frequency from 1 μ Hz to 1MHz and variable symmetry.

- The backlight turns on when this function is selected.
- You can set Freq/Period, Ampl/HiLevel, Offset/LoLevel, Symmetry and Start Phase of ramp waveform.



Output Pulse with frequency from 1 μ Hz to 25MHz and variable pulse width and edge time.

- The backlight turns on when this function is selected.
- You can set Freq/Period, Ampl/HiLevel, Offset/LoLevel, Width/Duty, Leading, Trailing and Start Phase of pulse waveform.



Output Gauss Noise with 60MHz bandwidth.

- The backlight turns on when this function is selected.
- You can set Ampl/HiLevel and Offset/LoLevel of Noise.



Output Arbitrary waveform with frequency from 1 μ Hz to 20MHz.

- Support **Sample Rate** and **Frequency** output modes.
- Up to 160 built-in waveforms and support powerful arbitrary waveform editing function.
- The backlight turns on when this function is selected.
- You can set Freq/Period, Ampl/HiLevel, Offset/LoLevel and Start Phase of arbitrary waveform.

14. Function keys



Output multiple types of modulated waveforms.

- Support multiple modulation types: AM, FM, PM, ASK, FSK, PSK and PWM.
- Support internal and external modulation sources.
- The backlight turns on when this function is selected.



Output sweep waveform for Sine, Square, Ramp and Arb (except DC).

- 3 sweep types: Linear, Log and Step.
- 3 types of trigger sources: Internal, External and Manual.
- Provide frequency mark function used to control the status of the sync signal.
- The backlight turns on when this function is selected.



Output Burst waveform for Sine, Square, Ramp, Pulse and Arb (except DC).

- 3 burst types: NCycle, Infinite and Gated.
- Noise can also be used to generate Gated Burst.
- 3 types of trigger sources: Internal, External and Manual.
- The backlight turns on when this function is selected.



Used to set the auxiliary function parameters and system parameters. The backlight turns on when this function is selected.



Store or recall the instrument state or the user-defined arbitrary waveform data.

- A nonvolatile memory (C disk) is built in and a USB storage device (D disk) can be connected.
- The backlight turns on when this function is selected.



To get the help information of any front panel key or menu softkey, press this key and then press the desired key.

Note:

- 1) When the instrument is working in remote mode, press this key to return to local mode.
- 2) Used to lock or unlock the keyboard. Press and hold **Help** to lock the front panel keys and at this point, the front panel keys (except **Help**) are not available. Press and hold this key again to unlock.

15. Menu Softkeys

Correspond to the left displayed menus respectively. Press this softkey to activate the corresponding menu.

16. LCD

3.5 inches TFT (320×240) color LCD display. The current function menu, settings, system state as well as prompt messages and etc. can be clearly displayed (for the detailed information, refer to "**User Interface**").

Rear Panel Overview

The rear panel of DG1000Z is as shown in the figure below. Click the numbers in the figure to view the corresponding description.

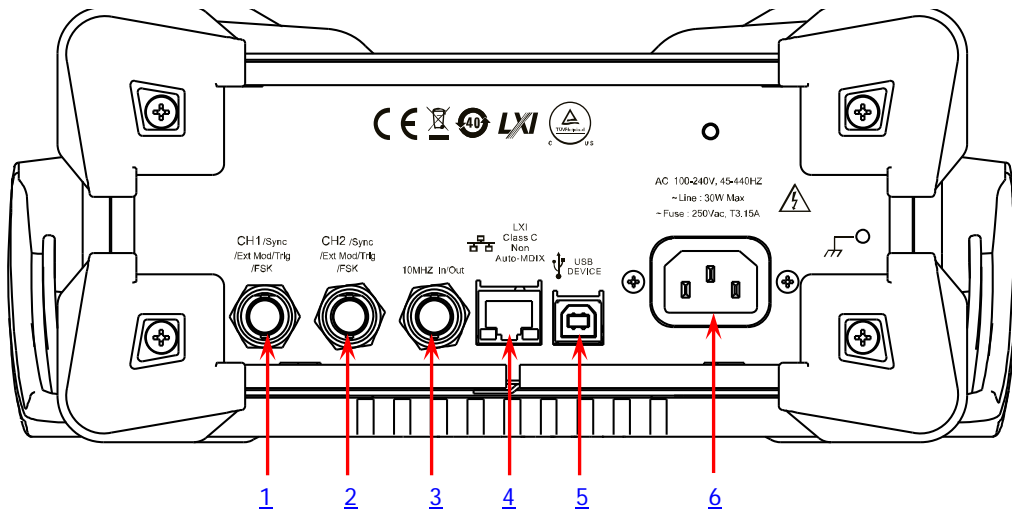

Figure 1-2 Rear Panel

1. [CH1/Sync/Ext Mod/Trig/FSK]

BNC female connector with 50 Ω nominal impedance.
Its function is determined by the current work mode of CH1.

CH1 /Sync
/Ext Mod/Trig
/FSK

1) Sync

When the output of CH1 is enabled, this connector outputs the corresponding sync signal. For detailed information about the characteristics of the sync signals corresponding to various output signals, refer to the introduction in "**Sync Set**".

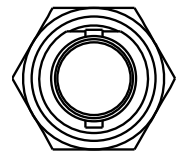

2) Ext Mod

When AM, FM, PM or PWM of CH1 is enabled and external modulation source is selected, this connector accepts an external modulation signal and the input impedance is 1000 Ω . For the detailed introduction, refer to "**Modulation**".

3) FSK

When ASK, FSK or PSK of CH1 is enabled and external modulation source is selected, this connector accepts an external modulation signal whose polarity can be set by users and the input impedance is 1000 Ω . For the detailed introduction, refer to "**Modulation**".

4) Trig In

When Sweep or Burst of CH1 is enabled and external trigger source is selected, this connector accepts an external trigger signal whose polarity can be set by users.

5) Trig Out

When Sweep or Burst of CH1 is enabled and internal or manual trigger source is selected, this connector outputs a trigger signal with specified edge type.

2. [CH2/Sync/Ext Mod/Trig/FSK]

BNC female connector with 50Ω nominal impedance.
Its function is determined by the current work mode of CH2.

CH2 /Sync
/Ext Mod/Trig
/FSK

1) Sync

When the output of CH2 is enabled, this connector outputs the corresponding sync signal. For detailed information about the characteristics of the sync signals corresponding to various output signals, refer to the introduction in "**Sync Set**".

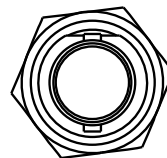
**2) Ext Mod**

When AM, FM, PM or PWM of CH2 is enabled and external modulation source is selected, this connector accepts an external modulation signal and the input impedance is 1000Ω. For the detailed introduction, refer to "**Modulation**".

3) FSK

When ASK, FSK or PSK of CH2 is enabled and external modulation source is selected, this connector accepts an external modulation signal whose polarity can be set by users and the input impedance is 1000Ω. For the detailed introduction, refer to "**Modulation**".

4) Trig In

When Sweep or Burst of CH2 is enabled and external trigger source is selected, this connector accepts an external trigger signal whose polarity can be set by users.

5) Trig Out

When Sweep or Burst of CH2 is enabled and internal or manual trigger source is selected, this connector outputs a trigger signal with specified edge type.

3. [10MHz In/Out]

BNC female connector with 50Ω nominal impedance.

The function of this connector is determined by the type of the clock source.

- 1) When internal clock source is selected, this connector (as 10MHz Out) outputs the 10MHz clock signal generated by the internal crystal oscillator inside the generator.
- 2) When external clock source is selected, this connector (as 10MHz In) accepts an external 10MHz clock signal.

10MHz In/Out

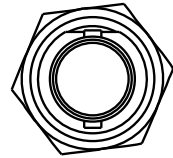

This connector is typically used to synchronize multiple instruments. For more detailed information about the signals mentioned above, please refer to the introduction in “**Clock Source**”.

4. LAN

Used to connect the generator to your computer or the network of your computer for remote control. An integrated testing system may be built, as the generator conforms to the LXI Core Device 2011 class standard of LAN-based instrument control.

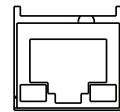
LXI
Class C
Non
Auto-MDIX

5. USB Device

Used to connect the generator to a computer which can control the generator remotely using PC software or by programming. It can also be connected to a PictBridge printer to print the contents displayed in the screen.

USB
DEVICE

6. AC Power Input

The AC power supply specification of this signal generator is 100-240V, 45-440Hz. The maximum input power of the instrument cannot exceed 30W. The specification of the fuse is 250V, T3.15A.

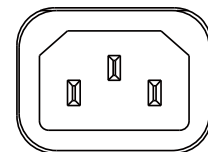
AC 100-240V, 45-440HZ
~Line : 30W Max
~Fuse : 250Vac, T3.15A

Power On and Inspection

To Connect to Power

Please connect the generator to AC power supply using the power cord supplied in the accessories (as shown in the figure below). The AC power supply specification of this generator is 100-240V, 45-440Hz. The maximum input power of the instrument cannot exceed 30W. When the signal generator is connected to AC power supply via this connector, the instrument adjusts itself to select the correct voltage range automatically and users do not need to select the voltage range manually.

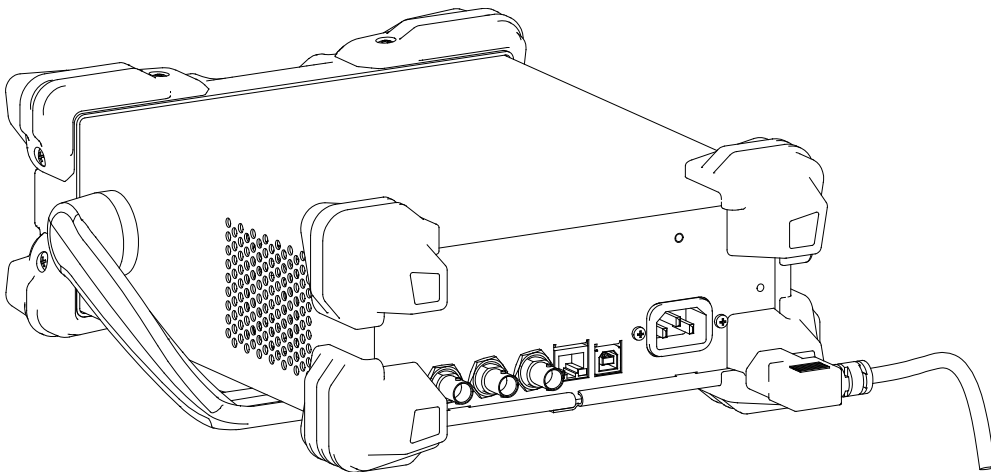



Figure 1-3 Connect to Power



CAUTION

To avoid electric shock, make sure that the instrument is correctly grounded.

Power-on

After the power supply is correctly connected, press the power key  at the front panel to turn on the generator. During the start-up, the instrument executes initialization and self-test. After that, the default interface is displayed. If the instrument does not start normally, please refer to the introduction in “**Troubleshooting**”.

To Set the System Language

DG1000Z series supports Chinese and English system languages. You can press **Utility** → **Language** to select the desired system language.

User Interface

DG1000Z user interface includes three types of display modes: **Dual Channels Parameters** (default), **Dual Channels Graph** and **Single Channel View**. In this manual, the **Dual Channels Parameters** display mode is mainly taken as an example to introduce the user interface.

Dual Channels Parameters Mode

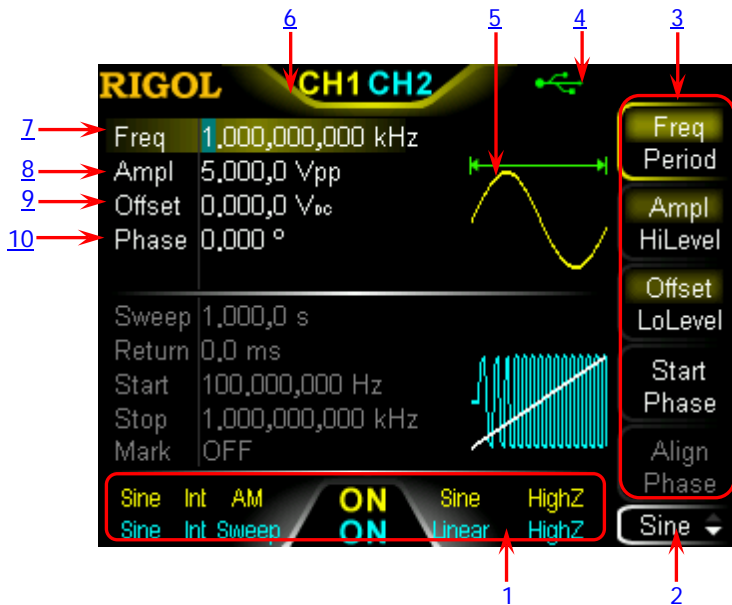
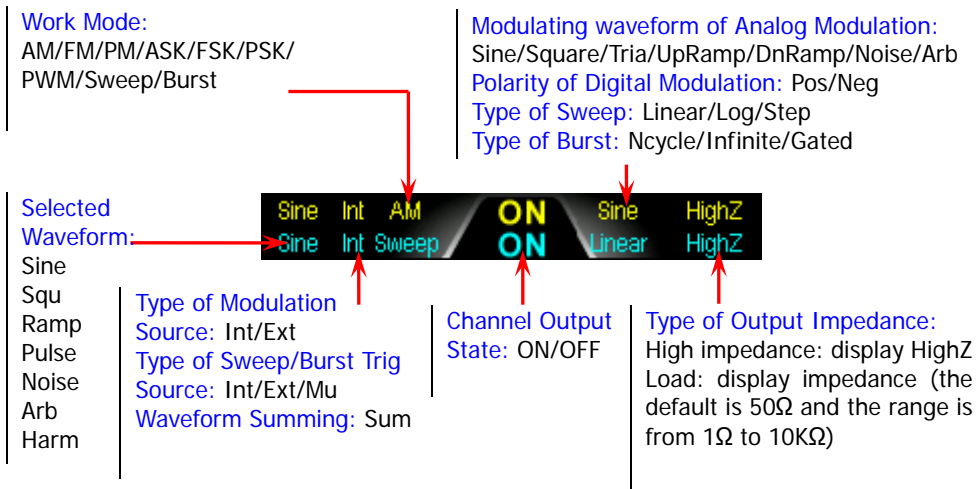

Figure 1-4 User Interface (Dual Channels Parameters Mode)

1. Channel Output Configuration Status Bar

Display the current output configurations of the two channels.



2. Current Function and Page Up/Down Indicator

Display the name of the function selected currently. For example, "Sine" is displayed when the sine is selected and "Edit" is displayed when the arbitrary waveform editing function is selected. Besides, the up and down arrows at the right of the function name are used to indicate whether page up/down is permitted now.

3. Menu

Display the operation menu of the function selected currently.

4. Status Bar

: displayed when the instrument is connected into LAN correctly.

: displayed when the instrument is in remote mode.

: displayed when the front panel of the instrument is locked.

: displayed when a USB storage device is detected.

: displayed when the instrument is connected with power amplifier correctly.

5. Waveform

Display the waveform currently selected in each channel.

6. Channel Status Bar

Used to indicate the selected status and on/off status of the channels. When CH1 is selected, the border of the bar is displayed in yellow. When CH2 is selected, the border of the bar is displayed in blue. When the output of CH1 is enabled, the "CH1" in the bar is highlighted in yellow. When the output of CH2 is enabled, the "CH2" in the bar is highlighted in blue.

Note: you can enable the outputs of the two channels but you cannot select the two channels at the same time.

7. Frequency

Display the waveform frequency of the channel. Press **Freq/Period** to highlight "Freq" and use the numeric keyboard or direction keys and knob to modify this parameter.

8. Amplitude

Display the waveform amplitude of the channel. Press **Ampl/HiLevel** to highlight "Ampl" and use the numeric keyboard or direction keys and knob to modify this parameter.

9. Offset

Display the waveform DC offset of the channel. Press **Offset/LoLevel** to highlight "Offset" and use the numeric keyboard or direction keys and knob to modify this parameter.

10. Phase

Display the waveform start phase of the channel. Press **Start Phase** and use the numeric keyboard or direction keys and knob to modify this parameter.

Dual Channels Graph Mode

Press **Utility** → **System** → **Display** → **DispMod** to select “Dual Graph”, as shown in the figure below.

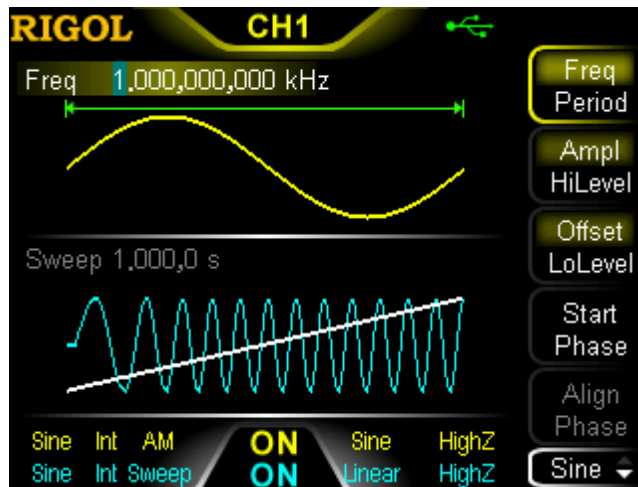

Figure 1-5 User Interface (Dual Channels Graph Mode)

Single Channel View Mode

Press **Utility** → **System** → **Display** → **DispMode** to select “Single View”, as shown in the figure below.

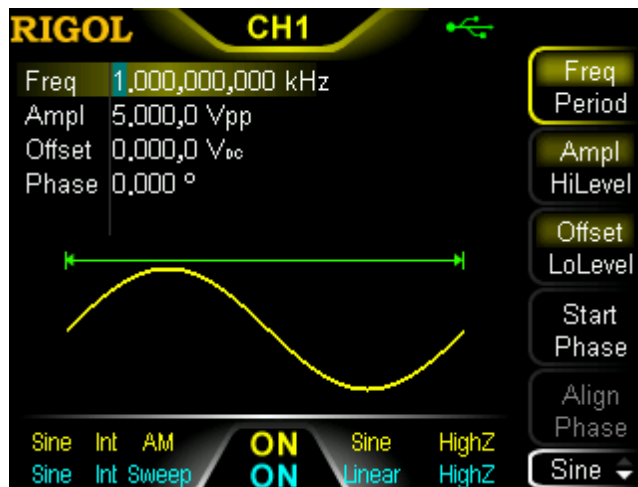

Figure 1-6 User Interface (Single Channel Mode)





To Use the Built-in Help System

DG1000Z built-in help system provides help information for each key and menu softkey at the front panel. When operating the instrument, users can view the help information of any key at any time.

1. Acquire the built-in help

Press **Help** and the backlight turns on. Then press the desired key or menu softkey and the corresponding help information is displayed.





2. Page Up/Down

When the help information is displayed in multiple pages, users can acquire the help information on the previous or next page using  (the previous line)/ (the next line)/ (page up)/ (page down) or the knob.

3. Close the current help information

When help information is displayed in the interface, pressing  at the front panel, the help information interface is closed and the interface before entering the built-in help system is displayed.

4. Common help topics

Press **Help** twice to open the common help topics list. Use /// or the knob to select the desired help topic and press **Select** to view the corresponding help information.

Rack Mount Kit Installation (Option)

To install this instrument into a standard 19 inches cabinet, please order rack mount kit RM-1-DG1000Z (for installing single instrument) or RM-2-DG1000Z (for installing dual instruments) and correctly install them according to this section.

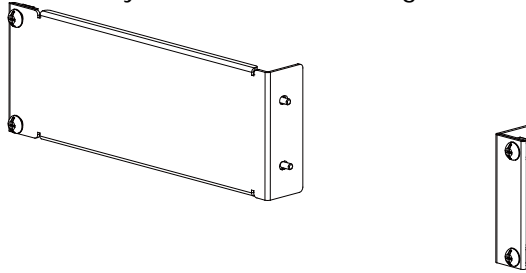

Figure 1-7 Rack Mount Kit (RM-1-DG1000Z)

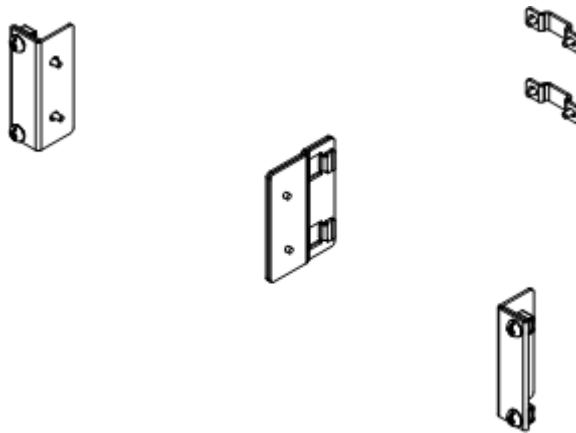

Figure 1-8 Rack Mount Kit (RM-2-DG1000Z)

To Install Single Instrument

Kit Parts List

Table 1-1 RM-1-DG1000Z Kit Parts List

No.	Name	Qty	Description
①	Front Filler Panel	1	
②	Fixing Part	1	
③	M4 Screw	4	M4×8 Cross Recessed Pan Head Screw
④	M6 Screw	4	M6×16 Phil-Slot Pan Head Screw
⑤	M6 Nut	4	M6×5 Lock Blade Square Nut

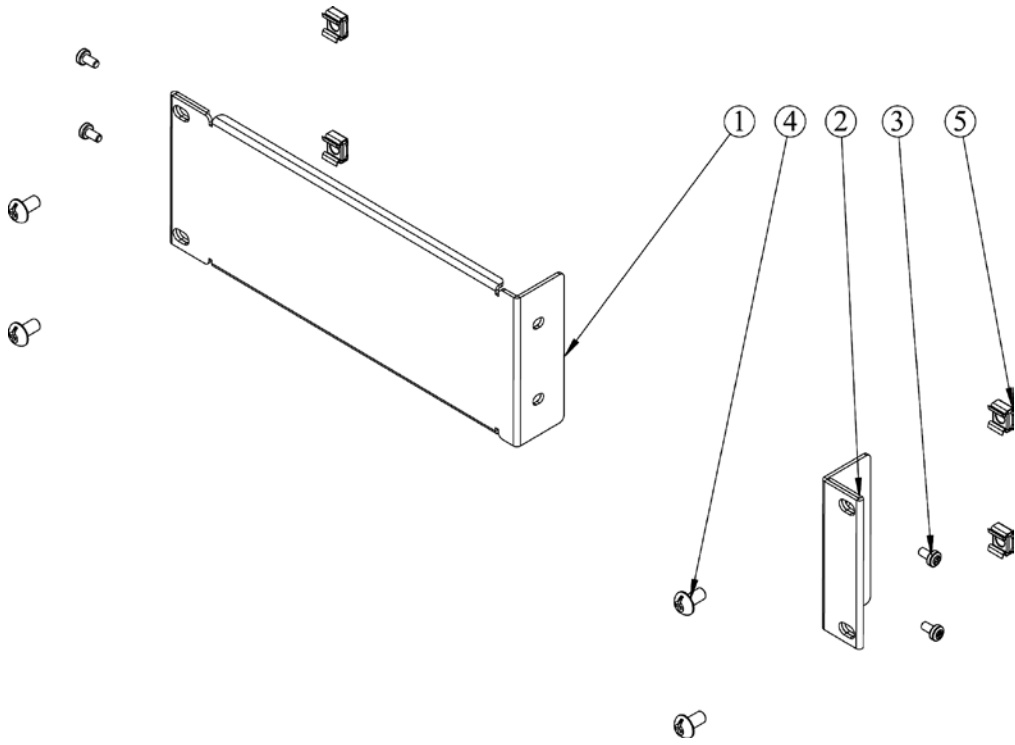

(a)

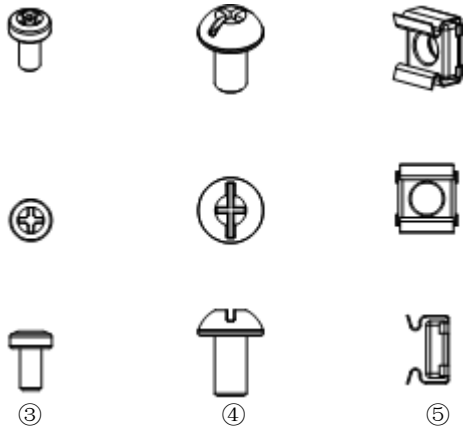

(b)

Figure 1-9 RM-1-DG1000Z Kit Parts

Installation Tool

PH2 Phillips Screwdriver (recommended).

Installation Space

The following requirements must be fulfilled by the machine cabinet in which the instrument is mounted.

- The machine cabinet must be a standard 19-inch one.
- At least 2U (88 mm) space should be provided by the machine cabinet.
- The depth inside the machine cabinet should not be less than 300.2 mm.

The dimension of the instrument after being installed is as shown below.

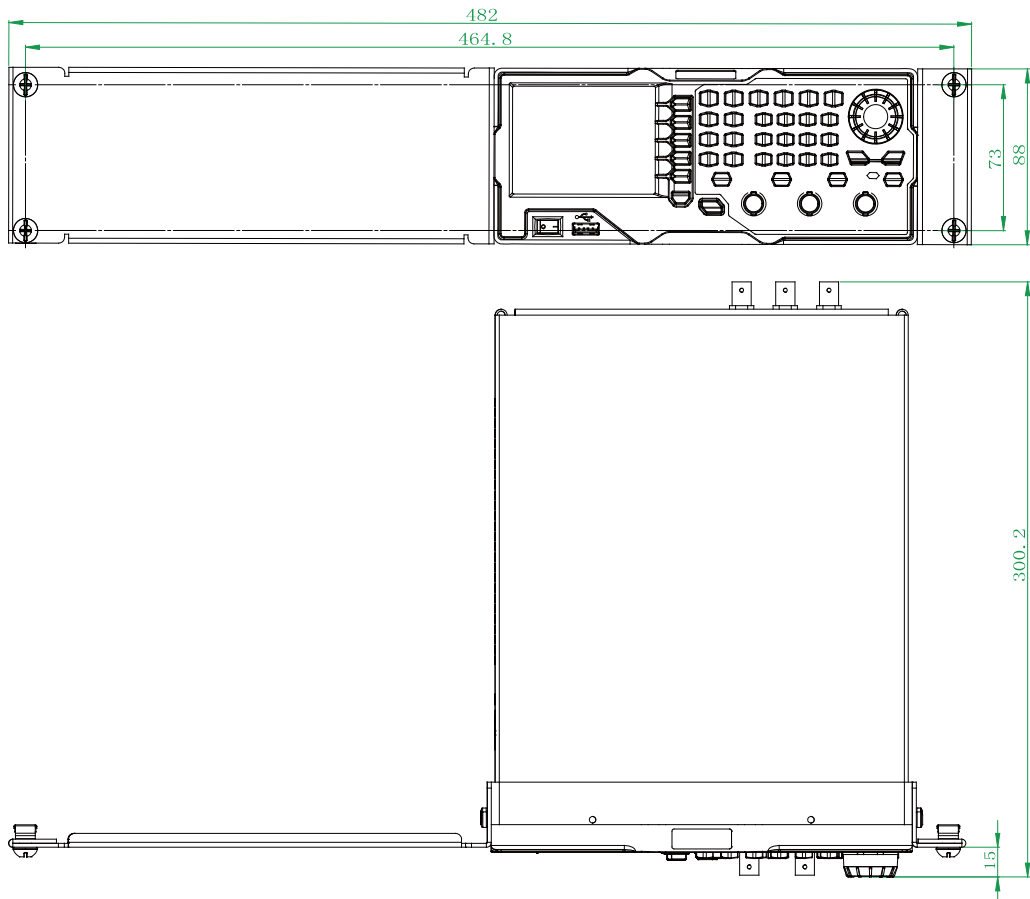

Installation Procedure



CAUTION

Only authorized operator can execute the installation operation. Improper installation might result in damage of the instrument or incorrect installation of the instrument on the rack.

1. First remove the handles of the instrument (hold the handles by sides of the instrument and pull them outward). And then remove the four rubber pads at the front and rear panel of the instrument respectively.
2. Fix the fixing part on one side of the front panel of the instrument using two M4 screws.

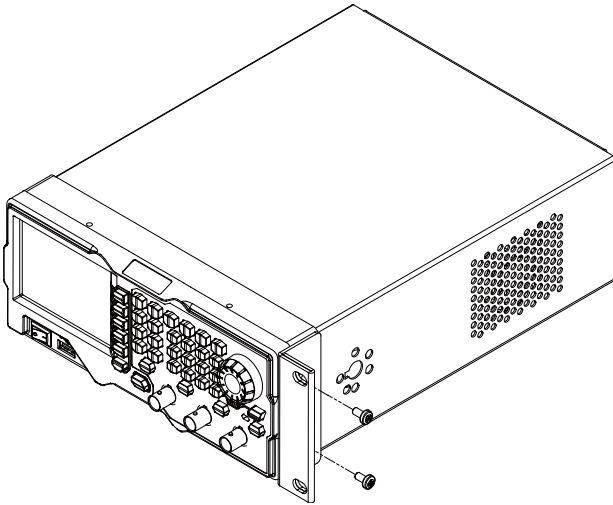

3. Fix the front filler panel on the other side of the front panel of the instrument using two M4 screws.

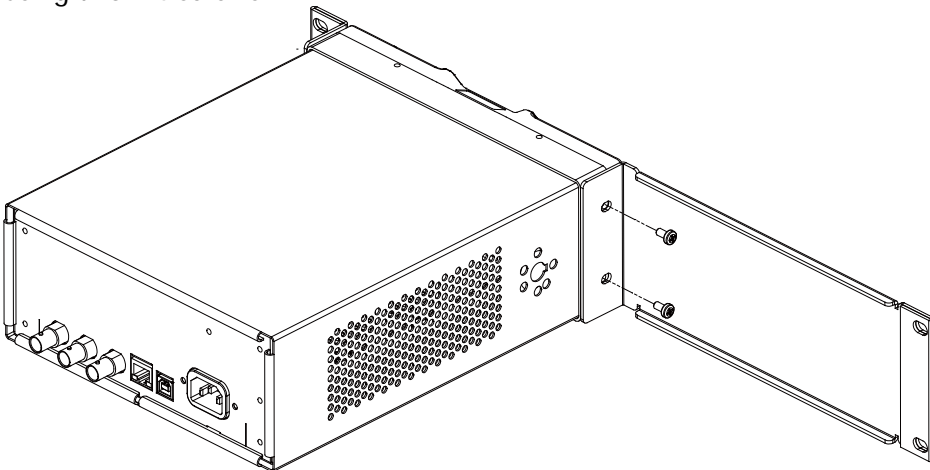

4. Mount the rack with the instrument fixed to it into a standard 19-inch machine cabinet with four M6 screws and four M6 square nuts.

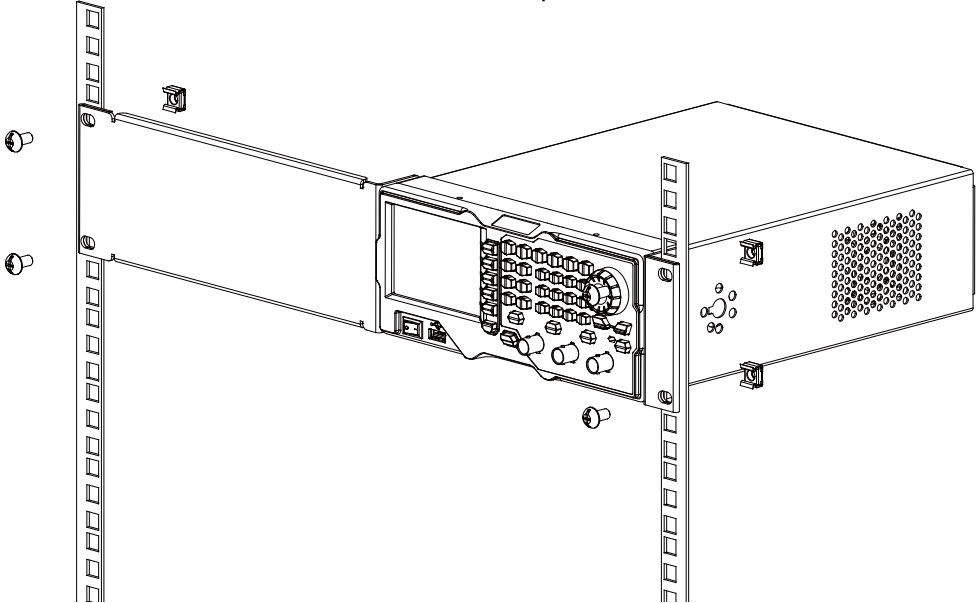

5. The figure of the single instrument after being installed correctly is as shown below.

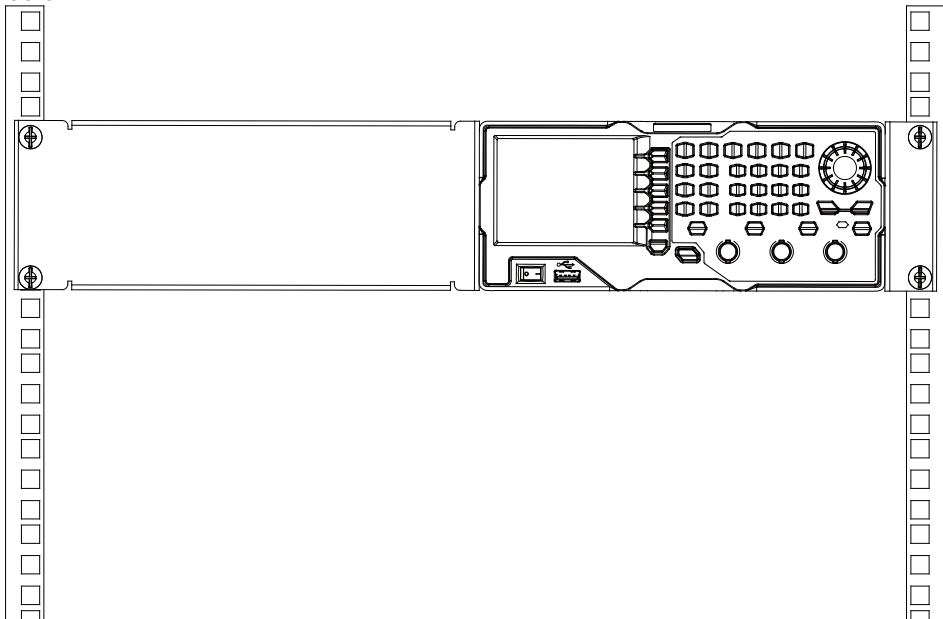

To Install Dual Instruments

Kit Parts List

Table 1-2 RM-2-DG1000Z Kit Parts List

No.	Name	Qty	Description
①	Fixing Part	2	
②	Connector A	1	
③	Connector B	1	
④	Tail Connector	2	
⑤	M4 Screw	4	M4×8 Cross Recessed Countersunk Head Screw
⑥	M4 Screw	8	M4×8 Cross Recessed Pan Head Screw
⑦	M6 Screw	4	M6×16 Phil-Slot Pan Head Screw
⑧	M6 Nut	4	M6×5 Lock Blade Square Nut

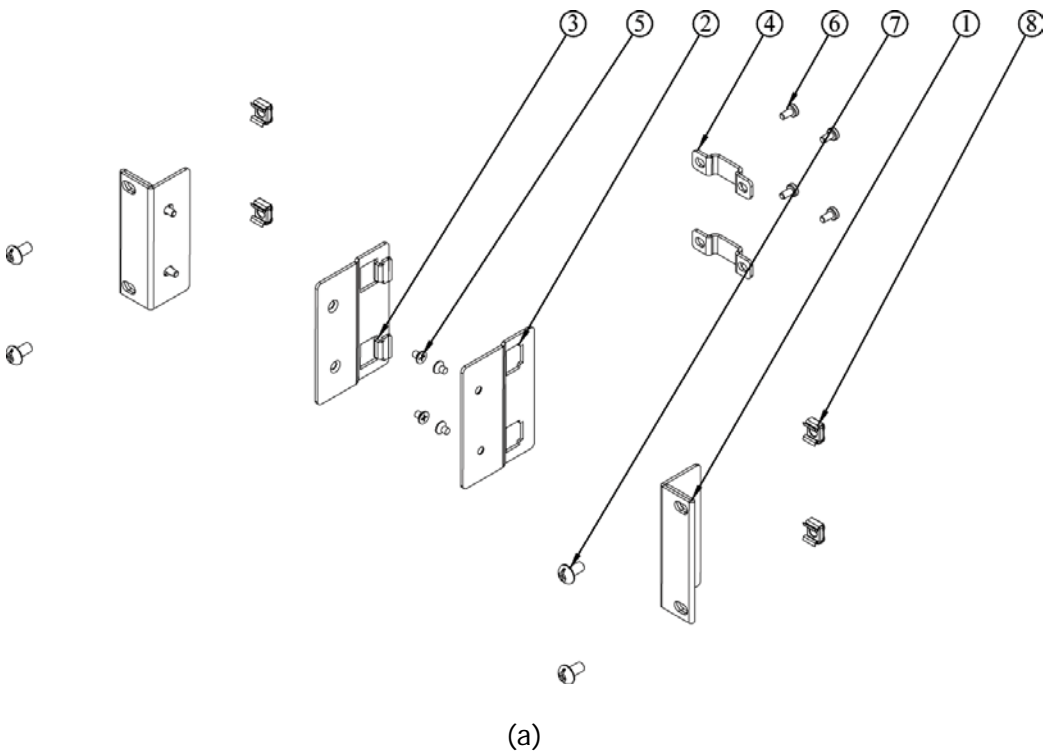

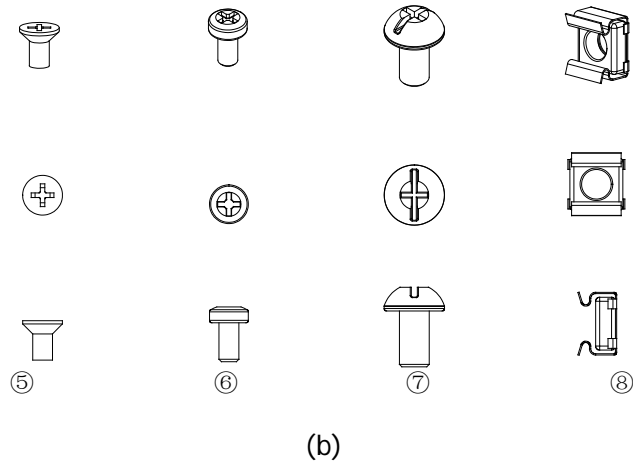

Figure 1-10 RM-2-DG1000Z Kit Parts

Installation Tool

PH2 Phillips Screwdriver (recommended).

Installation Space

The following requirements must be fulfilled by the machine cabinet in which the instrument is mounted.

- The machine cabinet must be a standard 19-inch one.
- At least 2U (88 mm) space should be provided by the machine cabinet.
- The depth inside the machine cabinet should not be less than 300.2 mm.

The dimensions of the instruments after being installed are as shown below.

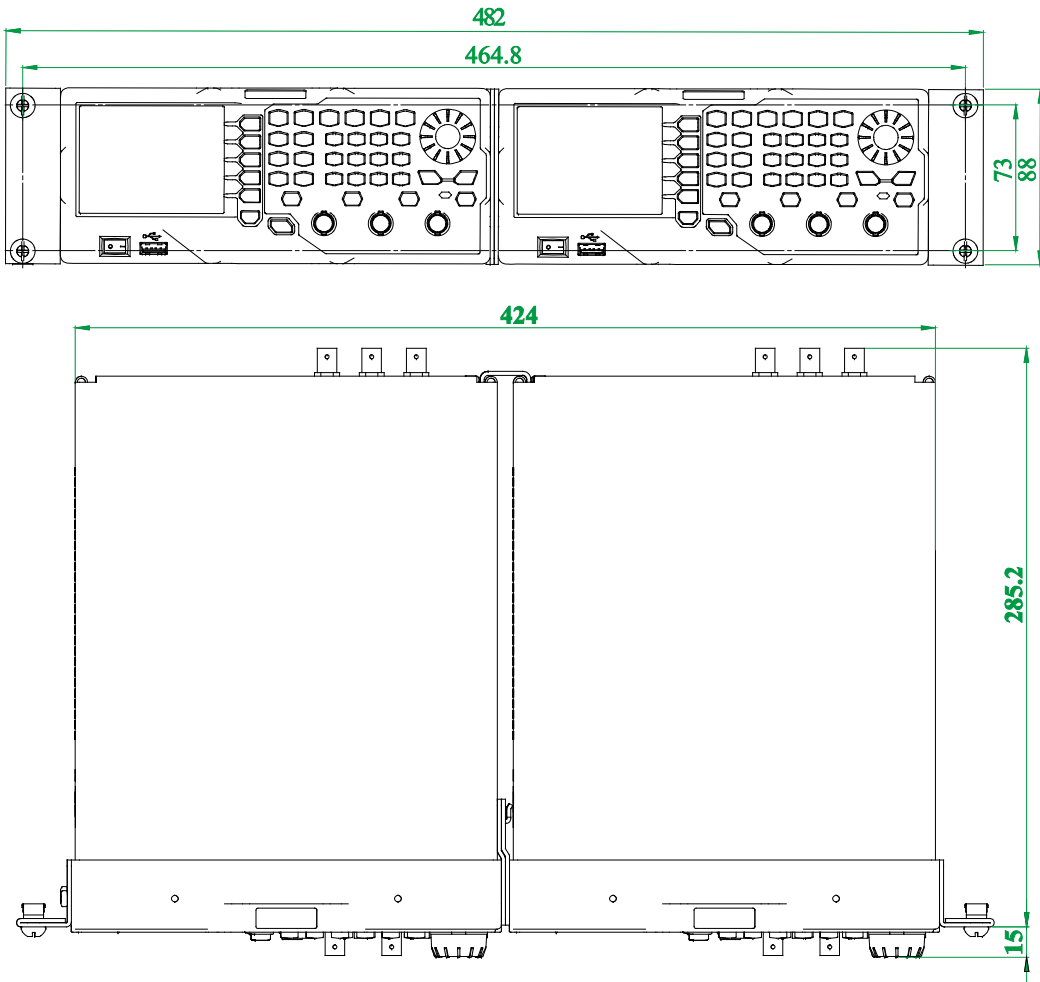

Installation Procedure



CAUTION

Only authorized operators can execute the installation operation. Improper installation might result in damage of the instrument or incorrect installation of the instrument on the rack.

1. First remove the handles of the two instruments (hold the handles by sides of the instrument and pull them outward). And then remove the four rubber pads on the front and rear panel of the two instruments respectively.
2. Fix one fixing part on the right side of the front panel of the instrument A using two M4 cross recessed pan head screws. Fix the connector A on the left side of the front panel of the instrument A using two M4 cross recessed countersunk head screws.

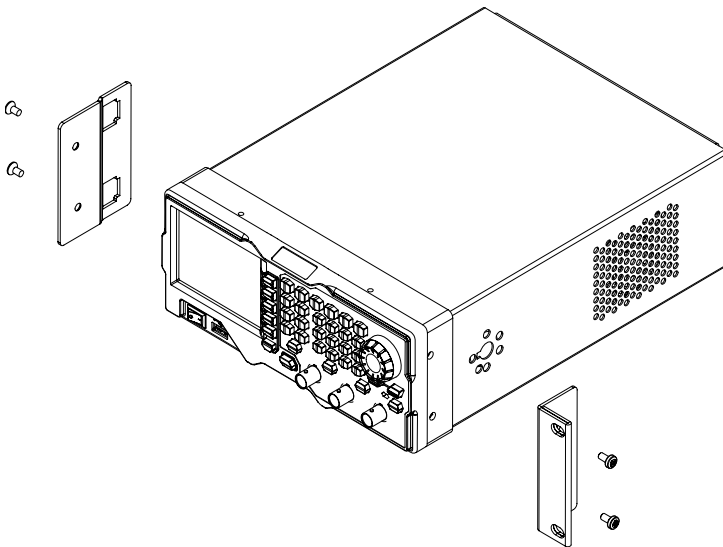

- Fix the other fixing part on the left side of the front panel of the instrument B using two M4 cross recessed pan head screws. Fix the connector B on the right side of the front panel of the instrument B using two M4 cross recessed countersunk head screws.

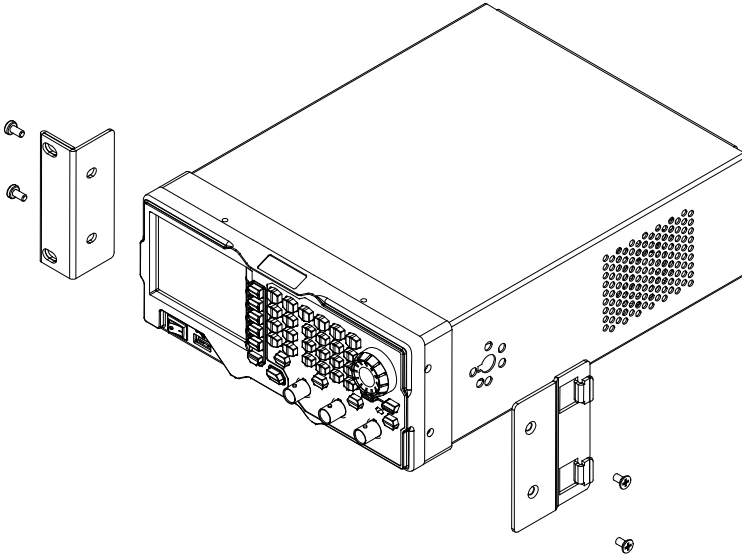

- Connect the connector A and B.

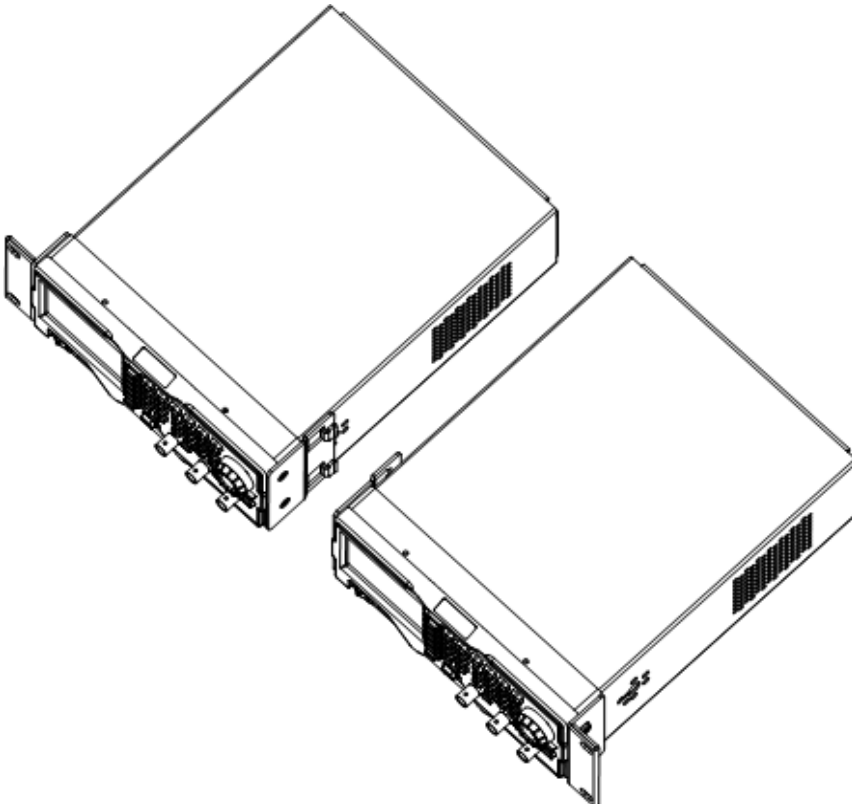

5. Fix the two tail connectors at the connection of the rear panel of the two instruments respectively using two M4 cross recessed pan head screws.

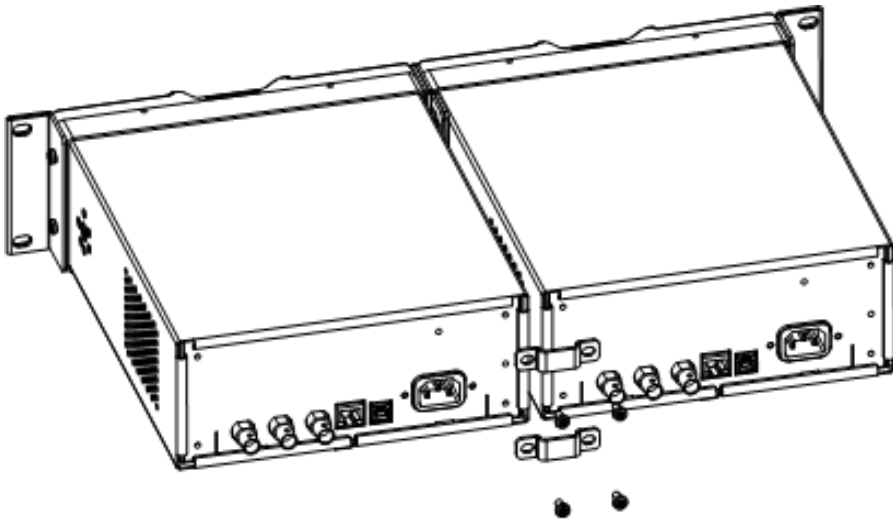

6. Mount the rack with two instruments fixed to it into a standard 19-inch machine cabinet with four M6 screws and four M6 square nuts.

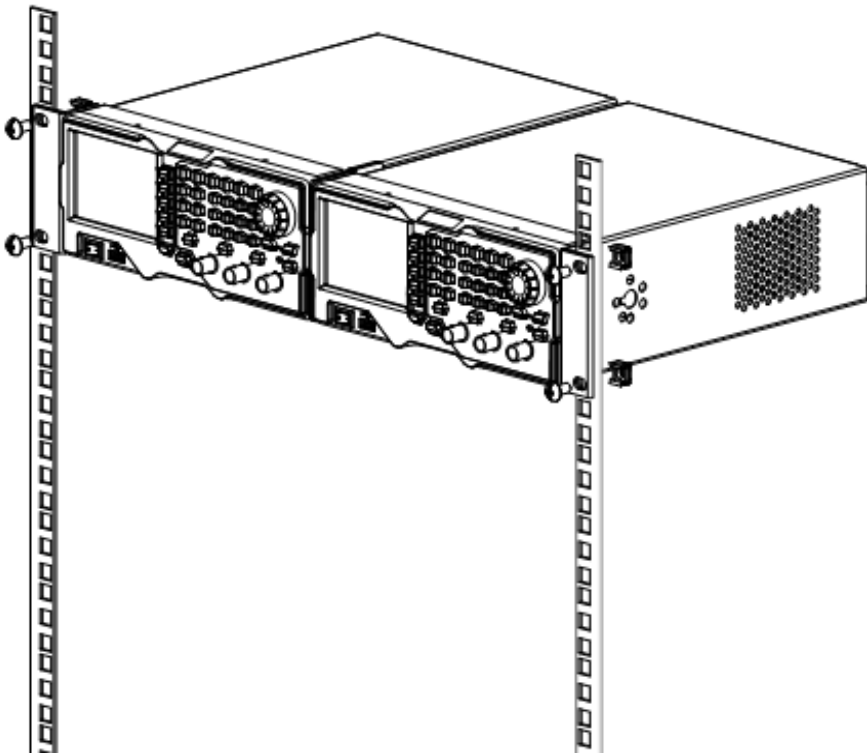

- 7. The figure of the dual instruments after being installed correctly is as shown below.

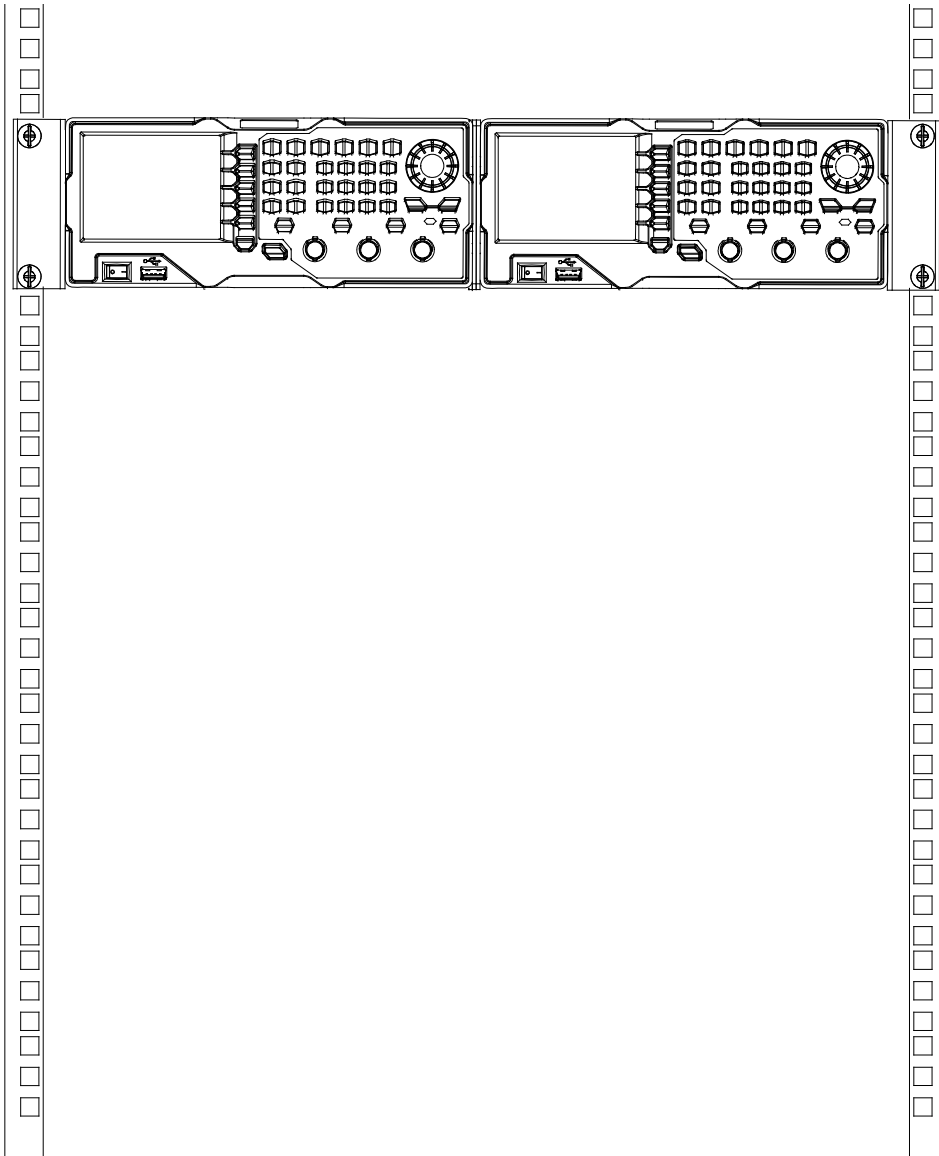

Chapter 2 Front Panel Operations

This chapter introduces the main functions and operation methods of DG1000Z.

Subjects in this chapter:

- To Output Basic Waveform
- To Output Arbitrary Waveform
- To Output Harmonic
- Modulation
- Sweep
- Burst
- Counter
- Store and Recall
- Utility and System Settings

To Output Basic Waveform

DG1000Z series can output basic waveforms (Sine, Square, Ramp, Pulse and Noise) from one of the channels separately or from the two channels at the same time. At start-up, the dual channels are configured to output a sine waveform with 1kHz frequency and 5Vpp amplitude by default. Users can configure the instrument to output various basic waveforms.

To Select Output Channel

The front-panel key **CH1 | CH2** is used to switch the currently selected channel between CH1 and CH2. At start-up, CH1 is selected by default and the corresponding area in the user interface is highlighted and the border of the channel status bar is displayed in yellow. At this point, pressing **CH1 | CH2** at the front panel to select CH2, the corresponding area in the user interface is highlighted and the border of the channel status bar is displayed in blue.

After the desired channel is selected, users can configure the waveform and parameters of the channel selected.





KEY POINT:

CH1 and CH2 can not be selected at the same time. Users can first select CH1 and then select CH2 after configuring the waveform and parameters of CH1.

To Select Basic Waveform

DG1000Z can output 5 types of basic waveforms including Sine, Square, Ramp, Pulse and Noise. The five function keys at the front panel are used to select the corresponding waveform. Press the corresponding key to select the desired waveform. At this point, the backlight of the button turns on and the corresponding function name and parameter setting menu (as shown in the table below) are displayed at the right of the user interface. At start-up, CH1 is selected by default.

Table 2-1 Basic Waveforms

Basic Waveforms		Sine	Square	Ramp	Pulse	Noise
Function Keys						
Function Name		Sine	Squ	Ramp	Pulse	Noise
Parameters	Frequency/ Period	✓	✓	✓	✓	
	Amplitude/ High Level	✓	✓	✓	✓	✓
	Offset/ Low Level	✓	✓	✓	✓	✓
	Start Phase	✓	✓	✓	✓	
	Align Phase	✓	✓	✓	✓	
	Duty Cycle		✓			
	Symmetry			✓		
	PulseWidth /DutyCycle				✓	
	Leading Edge				✓	
	Trailing Edge				✓	

To Set Frequency/Period

Frequency is one of the most important parameters of basic waveforms. For different instrument models and waveforms, the setting ranges of frequency are different. For detailed information, please refer to "Frequency Characteristics" in "**Specifications**". The default frequency is 1kHz.

The frequency displayed on the screen is the default value or the frequency previously set. When the instrument function is changed, if this frequency is valid under the new function, the instrument will still use this frequency; otherwise, the instrument would display prompt message and set the frequency to the frequency upper limit of the new function automatically.

Press **Freq/Period** to highlight "Freq". At this point, use the numeric keyboard to input the desired frequency value and then select the desired unit from the pop-up menu.

- The frequency units available are MHz, kHz, Hz, mHz and μ Hz.
- Press this softkey again to switch to period setting. At this point, "Period" is highlighted.
- The period units available are sec, msec, μ sec and nsec.

Users can also use the direction keys and knob to set the parameter value: use the direction keys to move the cursor to select the digit to be edited and then rotate the knob to change the number.

To Set Amplitude/High Level

The amplitude setting range is limited by the “Impedance” and “Freq/Period” settings. Please refer to “Output Characteristics” in “**Specifications**”. The default value is 5Vpp.

The amplitude displayed on the screen is the default value or the amplitude previously set. When the instrument configuration (such as frequency) is changed, if this amplitude is valid, the instrument will still use this amplitude; otherwise, the instrument would display prompt message and set the amplitude to the amplitude upper limit of the new configuration automatically. Users can also use “High Level” or “Low Level” to set the amplitude.

Press **Ampl/HiLevel** to highlight “Ampl”. At this point, use the numeric keyboard to input the desired amplitude value and then select the desired unit from the pop-up menu.

- The amplitude units available are Vpp, mVpp, Vrms, mVrms and dBm (invalid in HighZ).
- Press this softkey again to switch to high level setting. At this point, “HiLevel” is highlighted.
- The high level units available are V and mV.

Users can also use the direction keys and knob to set the parameter value: use the direction keys to move the cursor to select the digit to be edited and then rotate the knob to change the number.

KEY POINTS:

1. How to convert the amplitude in Vpp to the corresponding value in Vrms?

Method:

Vpp is the unit for signal peak-peak value and Vrms is the unit for signal effective value. The default unit is Vpp. Press in the numeric board to quickly switch the current amplitude unit.

Note:

For different waveforms, the relation between Vpp and Vrms is different. The relation of the two units is as shown in the figure below (take sine waveform as an example).

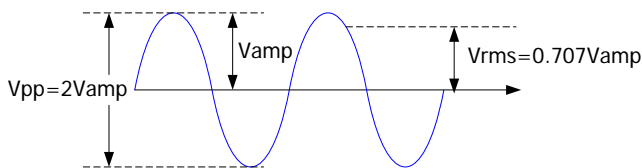

According to the figure above, the conversion relation between V_{pp} and V_{rms} fulfills the following equation:

$$V_{pp} = 2\sqrt{2}V_{rms}$$

For example, if the current amplitude is $5V_{pp}$, press \square in the numeric keyboard and select "Vrms" to convert $5V_{pp}$ to the corresponding value in Vrms. For sine waveform, the converted value is $1.768V_{rms}$.

2. How to set the amplitude of waveform in the unit of dBm?

Method:

- 1) Press **CH1 | CH2** to select the desired channel.
- 2) Press **Utility** → **ChannelSet** → **OutputSet** → **Imped** to select "Load" and set proper load value using numeric keyboard.
- 3) Select the desired waveform and press **Ampl/HiLevel** to highlight "Ampl". Use the numeric keyboard to input the desired value and then select **dBm** from the pop-up menu.

Note:

dBm is the unit for signal power absolute value and the conversion relation between dBm and Vrms fulfills the following equation:

$$dBm = 10\lg\left(\frac{V_{rms}^2}{R} \times \frac{1}{0.001W}\right)$$

In this equation, R represents the channel output impedance value and it must be a certain value, so the unit dBm is not available when the output impedance is "HighZ".

For example, if the current output impedance is 50Ω and the amplitude is $1.768V_{rms}$ ($5V_{pp}$), press \square in the numeric keyboard and then select "dBm" to convert the amplitude value to the corresponding value in dBm. The converted value is $17.9601dBm$.

To Set Offset/Low Level

The DC offset setting range is limited by the “**Impedance**” and “**Ampl/HiLevel**” settings. Please refer to the “Output Characteristics” in “**Specifications**”. The default value is $0V_{DC}$.

The DC offset voltage displayed on the screen is the default value or the offset previously set. When the instrument configuration (such as impedance) is changed, if this offset is valid, the instrument will still use this offset; otherwise, the instrument would display prompt message and set the offset to the offset upper limit of the new configuration automatically.

Press **Offset/LoLevel** to highlight “Offset”. At this point, use the numeric keyboard to input the desired offset value and then select the desired unit from the pop-up menu.

- The DC offset voltage units available are V_{DC} and mV_{DC} .
- Press this softkey again to switch to low level setting. At this point, “LoLevel” is highlighted.
- The low level should be lower than the high level at least 1mV (the output impedance is 50Ω).
- The low level units available are V and mV.

Users can also use the direction keys and knob to set the parameter value: use the direction keys to move the cursor to select the digit to be edited and then rotate the knob to change the number.

To Set Start Phase

The setting range of start phase is from 0° to 360° and the default is 0°.

The start phase displayed on the screen is the default value or the phase previously set. When the instrument function is changed, the new function will still use this phase.

Press **Start Phase** to highlight the softkey. At this point, use the numeric keyboard to input the desired start phase value and then select the unit "°" from the pop-up menu.

Users can also use the direction keys and knob to set the parameter value: use the direction keys to move the cursor to select the digit to be edited and then rotate the knob to change the number.

Align Phase

DG1000Z series dual-channel generators enable to align the phases of the two channels. Pressing down this softkey will re-configure the two channels and enable the generator to output with specified frequency and start phase.

For two signals whose frequencies are the same or in multiple, this operation will align their phases. For example, assume a sine waveform (1kHz, 5Vpp, 0°) is outputted from CH1, while another one (1kHz, 5Vpp, 180°) from CH2. Use an oscilloscope to sample and display the two signals, you will see that the waveforms shown on the oscilloscope do not always have a phase deviation of 180°. At this point, press **Align Phase** on the generator and the waveforms shown on the oscilloscope will have a phase deviation of 180° without any adjustment of the start phase of the generator.

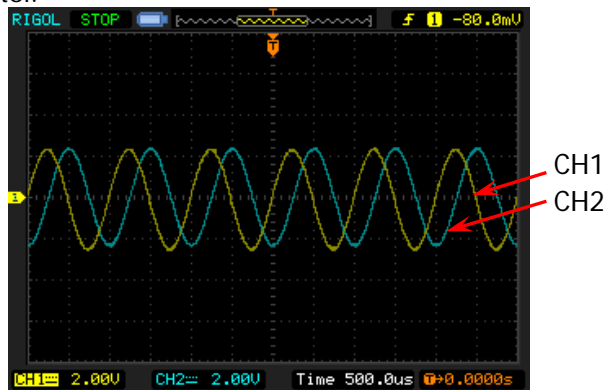

Figure 2-1 Before Aligning Phase

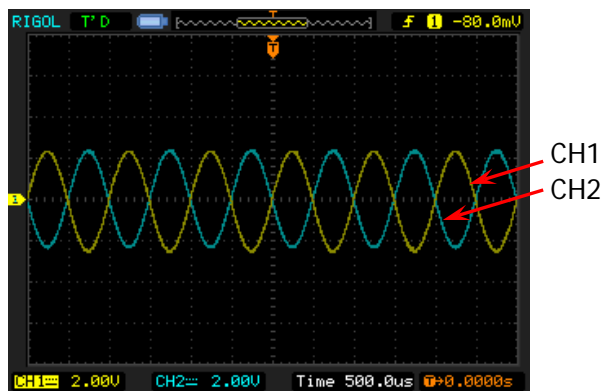

Figure 2-2 After Aligning Phase

KET POINTS:

The **Align Phase** menu is grayed out and disabled when any one of the two channels is in modulation mode.

To Set Duty Cycle (Square)

Duty cycle is defined as the percentage that the high level takes up in the whole period (as shown in the figure below). This parameter is only available when square is selected.

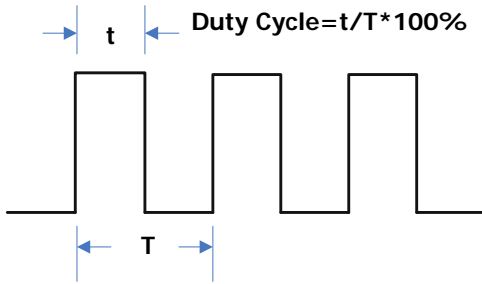

The setting range of duty cycle is limited by the "**Freq/Period**" setting. Please refer to "Signal Characteristics" in "**Specifications**". The default value is 50%.

Press **Duty Cycle** to highlight the softkey. At this point, use the numeric keyboard to input the desired duty cycle value and then select the unit "%" from the pop-up menu.

Users can also use the direction keys and knob to set the parameter value: use the direction keys to move the cursor to select the digit to be edited and then rotate the knob to change the number.

To Set Symmetry (Ramp)

Symmetry is defined as the percentage that the rising period takes up in the whole period (as shown in the figure below). This parameter is only available when ramp is selected.

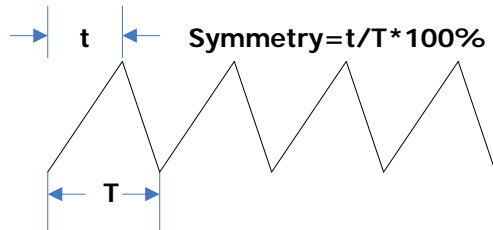

The setting range of symmetry is from 0% to 100% and the default is 50%.

Press **Symm** to highlight the softkey. At this point, use the numeric keyboard to input the desired symmetry value and then select the unit “%” from the pop-up menu.

Users can also use the direction keys and knob to set the parameter value: use the direction keys to move the cursor to select the digit to be edited and then rotate the knob to change the number.

To Set Pulse Width/Duty Cycle (Pulse)

Pulse width is defined as the time from the 50% threshold of a rising edge amplitude to the 50% threshold of the next falling edge amplitude (as shown in the figure below).

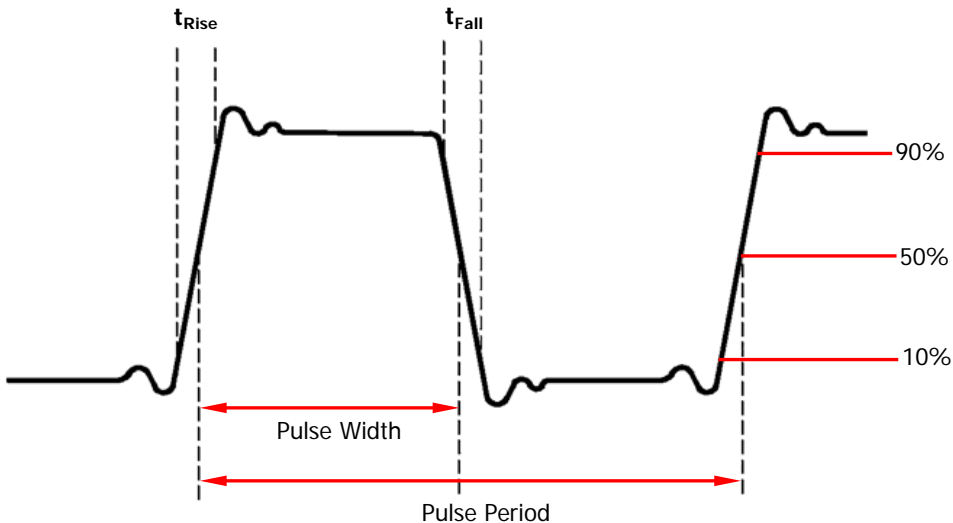

The setting range of pulse width is limited by the “Minimum Pulse Width” and the “Pulse Period” (for the ranges of “Minimum Pulse Width” and “Pulse Period”, please refer to “Signal Characteristics” in “**Specifications**”). The range of pulse width is from 16ns to 999.999 982 118ks and the default value is 500 μ s.

- Pulse Width \geq Minimum Pulse Width
- Pulse Width < Pulse Period - Minimum Pulse Width \times 2

Pulse duty cycle is defined as the percentage that the pulse width takes up in the whole period.

Pulse duty cycle and pulse width are correlative. Once a parameter is changed, the other will be automatically changed. Pulse duty cycle is limited by the “Minimum Pulse Width” and the “Pulse Period”. The range of pulse duty cycle is from 0.001% to 99.999% and the default is 50%.

- Pulse Duty Cycle \geq 100 \times Minimum Pulse Width \div Pulse Period
- Pulse Duty Cycle < 100 \times (1-2 \times Minimum Pulse Width \div Pulse Period)

Press **Width/Duty** to highlight “Width”. At this point, use the numeric keyboard to input the desired pulse width value and then select the desired unit from the pop-up menu.

- The pulse width units available are sec, msec, μ sec and nsec.
- Press this softkey again to switch to duty cycle setting.

Users can also use the direction keys and knob to set the parameter value: use the direction keys to move the cursor to select the digit to be edited and then rotate the knob to change the number.

To Set Leading/Trailing Edge Time (Pulse)

Leading (rising) edge time is defined as the duration of the pulse amplitude rising from 10% to 90% threshold, while Trailing (falling) edge time is defined as the duration of the pulse amplitude moving down from 90% to 10% threshold (as shown in the figure below).

The setting range of leading/trailing edge time is limited by the currently specified pulse width limit (as shown in the formula below). DG1000Z will automatically adjust the edge time to match the specified pulse width if the value currently set exceeds the limit value.

$$\text{Leading/Trailing Edge Time} \leq 0.625 \times \text{Pulse Width}$$

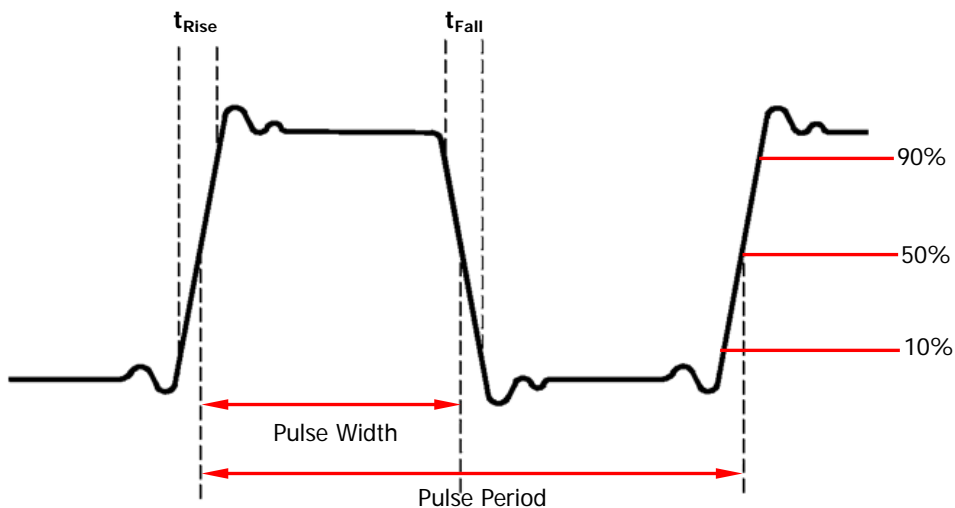

Press **Leading (Trailing)** to highlight "Leading" ("Trailing"). Use the numeric keyboard to input the desired value and then select the desired unit from the pop-up menu.

- The Leading/Trailing Edge Time units available are sec, msec, μ sec and nsec.
- Leading edge time and trailing edge time are independent from each other and users can set them separately.

Users can also use the direction keys and knob to set the parameter value: use the direction keys to move the cursor to select the digit to be edited and then rotate the knob to change the number.

To Enable Output

After configuring the parameters of the waveform selected, waveform output could be enabled.

Before enabling waveform output, you can also configure parameters (such as Impedance and Polarity) related to the channel output through **Channel Set** menu in **Utility**. For details, please refer to the introduction in “**Output Set**”.

Press **Output1** at the front panel to turn CH1 output on. At this point, the backlight of the button turns on and the **[CH1]** connector at the front panel outputs the configured waveform.

Example: To Output Sine Waveform

This section mainly introduces how to output a sine waveform (Frequency: 20kHz, Amplitude: 2.5Vpp, DC Offset: 500 mV_{DC}, Start Phase: 90°) from the **[CH1]** connector.

1. To select output channel

Press **[CH1 | CH2]** to select CH1. Now the border of the channel status bar is displayed in yellow.

2. To select the Sine

Press **[Sine]** to select the sine waveform. The backlight goes on and the corresponding menu is displayed in the right of the screen.

3. To set the frequency

Press **Freq/Period** to highlight "Freq", and then use the numeric keyboard to input 20. Then, select "kHz" from the pop-up menu.

4. To set the amplitude

Press **Ampl/HiLevel** to highlight "Ampl", and use the numeric keyboard to input 2.5. Then, select "Vpp" from the pop-up menu.

5. To set the offset

Press **Offset/LoLevel** to highlight "Offset", and then use the numeric keyboard to input 500. Then, select "mV_{DC}" from the pop-up menu.

6. To set the start phase

Press **Start Phase**, and then use the numeric keyboard to input 90. Then, select "°" from the pop-up menu. The start phase ranges from 0° to 360°.

7. To enable the output

Press **[Output1]** to turn CH1 output on. At this point, the backlight goes on and the **[CH1]** connector outputs the configured waveform.

8. To observe the output waveform

Connect the **[CH1]** connector of DG1000Z to the oscilloscope using BNC cable. The waveform is as shown in the figure below.

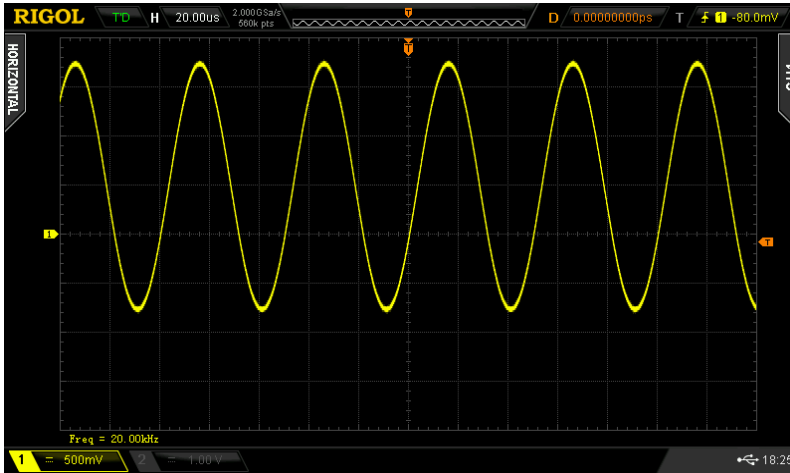

Figure 2-3 Sine Waveform

To Output Arbitrary Waveform

DG1000Z can output built-in or user-defined arbitrary waveforms from a single channel or from two channels at the same time. It not only provides 160 kinds of built-in arbitrary waveforms stored in the internal non-volatile memory but also allows users to edit the arbitrary waveform which can contain 8 to 16384 (16k) data points, namely 8pts to 16kpts. Users can store the edited arbitrary waveform in the internal or external memory (*.RAF file).

DG1000Z provides 8Mpts standard memory and 16Mpts optional memory for the arbitrary waveform. Users can edit the arbitrary waveform using PC software and output it after downloading it to the instrument via the remote interface or reading it from the USB storage device.

To Enable Arbitrary Waveform

Press **Arb** to enable arbitrary waveform function and open the operation menu of arbitrary waveform.

1. **Freq/Period:** set the output Frequency/Period of the arbitrary waveform. This menu is only displayed when the frequency output mode is selected.
2. **Sample Rate:** set the output Sample Rate of the arbitrary waveform. This menu is only displayed when the sample rate output mode is selected.
3. **Ampl/HiLevel:** set the Amplitude/High Level of the arbitrary waveform.
4. **Offset/LoLevel:** set the Offset/Low Level of the arbitrary waveform.
5. **Start Phase:** set the Start Phase of the arbitrary waveform.
6. **Align Phase:** refer to “Align Phase”.
7. **Arb Mode:** switch the arbitrary waveform output mode between “Frequency” and “Sample Rate”.
8. **Select Wform:** select DC, the built-in arbitrary waveforms, the arbitrary waveforms stored in internal or external memory or the volatile waveform.
9. **Edit Wform:** edit the selected waveform of the current channel or create a new waveform.

Please refer to “To Output Basic Waveform” to configure the parameters and output of the channels. This chapter will focus on “Sample Rate”, “Output Mode”, “Select Waveform” and “Edit Waveform”.

Output Mode and Sample Rate

DG1000Z supports Frequency and Sample Rate output modes.

1. Frequency Output Mode

Press **Arb** → **Arb Mode** to select the “Frequency” output mode.

In frequency output mode, users can set the frequency or period of the arbitrary waveform (the setting method please refer to “**To Set Frequency/Period**”) while the sample rate can not be changed. The instrument outputs an arbitrary waveform which is made up of certain points selected according to the current output frequency.

For arbitrary waveform, frequency output mode corresponds to period edit mode (**Arb** → **Edit Wform** → **Mode** → “Period”). If the currently selected arbitrary waveform is in the period edit mode when the state of **RealTime** under **Edit Wform** is “On”, the instrument will switch to frequency output mode automatically.

2. Sample Rate Output Mode

Press **Arb** → **Arb Mode** to select the “Sample Rate” mode.

In sample rate output mode, users can set the sample rate (the points outputted per second) while the frequency and period can not be changed. The instrument outputs the arbitrary waveform point by point according to the current sample rate.

After the sample rate output mode is selected, press **SRate** to input the desired sample rate value using the numeric keyboard and select the desired unit from the pop-up menu.

- The range available of the sample rate is from 1 μ Sa/s to 60MSa/s.
- The sample rate units available are MSa/s, kSa/s, Sa/s, mSa/s and μ Sa/s.

Users can also use the direction keys and knob to set the parameter value: use the direction keys to move the cursor to select the digit to be edited and then rotate the knob to change the number.

For arbitrary waveform, the sample rate output mode corresponds to the sample rate edit mode (**Arb** → **Edit Wform** → **Mode** → “Period”). If the currently selected arbitrary waveform is in the sample rate edit mode when the state of **RealTime** under **Edit Wform** is “On”, the instrument will switch to sample rate output mode automatically.

To Select Arbitrary Waveform

DG1000Z allows users to select DC, 160 built-in waveforms, arbitrary waveforms stored in internal or external memory of the instrument or volatile memory.

KEY POINTS:

After the desired waveform is selected, you can perform the operations below.

1. To output the selected waveform:

Press the corresponding output control key **Output1** or **Output2** and the specified waveform will be outputted from the channel.

2. To edit the selected waveform:

Please refer to the introduction in “**To Edit Arbitrary Waveform**”.

DC

DG1000Z can output DC signal with amplitude range from -10V to 10V (HighZ) or from -5V to 5V (the load is 50Ω). The figure below shows a sketch of the DC signal. Press **Arb** → **Select Wform** → **DC** to select DC signal.

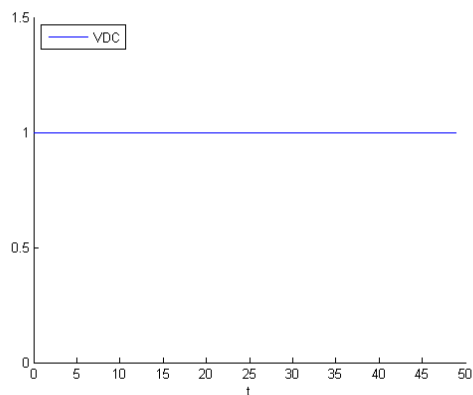

Figure 2-4 Sketch of DC signal

Built-In Waveform

DG1000Z has 160 built-in arbitrary waveforms as shown in Table 2-2. Press **Arb** → **Select Wform** → **BuiltIn** to enter the built-in waveform selection interface as shown in the figure below. Press **Engine**, **Medical**, **AutoElec** or **Maths** to select the corresponding item (each item has one or more sub-items). Press the corresponding menu key repeatedly to switch to the desired sub-item (the selected sub-item in the sub-item bar is highlighted) and rotate the knob to select the desired waveform (the selected waveform is highlighted). Then press **Select** to select the waveform which is highlighted.

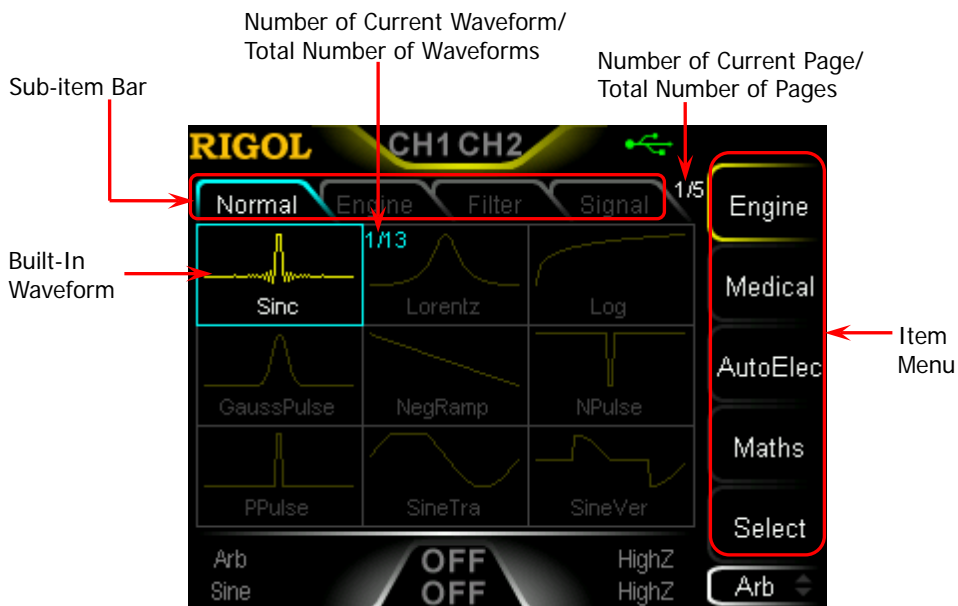

Figure 2-5 Built-in Waveform

Table 2-2 160 Built-in Arbitrary Waveforms

Sub-item	Waveform	Explanation
Engineering		
Normal	Sinc	Sinc function
	Lorentz	Lorentz function
	Log	Logarithm function and the base is 10
	GaussPulse	Gauss pulse
	NegRamp	Negative ramp
	NPulse	Negative pulse
	PPulse	Positive pulse
	SineTra	Sine-Tra waveform
	SineVer	Sine-Ver waveform
	StairDn	Stair-down waveform
StairUD	Stair-up and stair-down waveform	

	StairUp	Stair-up waveform
	Trapezia	Trapezia waveform
Engine	AmpALT	Gain oscillation curve
	AttALT	Attenuation oscillation curve
	RoundHalf	RoundHalf Wave
	RoundsPM	RoundsPM Waveform
	BlaseiWave	Time-velocity curve of explosive vibration
	DampedOsc	Time-displacement curve of damped oscillation
	SwingOsc	Kinetic energy- time curve of swing oscillation
	Discharge	Discharge curve of Ni-MH battery
	Pahcur	Current waveform of DC brushless motor
	Combin	Combination function
	SCR	SCR firing profile
Filter	Butterworth	Butterworth filter
	Chebyshev1	Chebyshev1 filter
	Chebyshev2	Chebyshev2 filter
Signal	TV	TV signal
	Voice	Voice signal
	Surge	Surge signal
	Radar	Analog radar waveform
	DualTone	Dual-tone signal
	Ripple	Ripple wave of battery
	Quake	Analog quake waveform
	Gamma	Gamma signal
	StepResp	Step-response signal
	BandLimited	Bandwidth-limited signal
	CPulse	C-Pulse
	CWPulse	CW pulse
	GateVibr	Gate self-oscillation signal
	LFMPulse	Linear FM pulse
MCNoise	Mechanical construction noise	
Mod	AM	Sectioned sine AM signal
	FM	Sectioned sine FM signal
	PFM	Sectioned pulse FM signal
	PM	Sectioned sine PM signal
	PWM	Sectioned PWM signal
Medical		
BIO	Cardiac	Cardiac signal
	EOG	Electro-Oculogram
	EEG	Electroencephalogram
	EMG	Electromyogram
	Pulseilogram	Pulsilogram
	ResSpeed	Speed curve of the respiration

	ECG1	Electrocardiogram 1
	ECG2	Electrocardiogram 2
	ECG3	Electrocardiogram 3
	ECG4	Electrocardiogram 4
	ECG5	Electrocardiogram 5
	ECG6	Electrocardiogram 6
	ECG7	Electrocardiogram 7
	ECG8	Electrocardiogram 8
	ECG9	Electrocardiogram 9
	ECG10	Electrocardiogram 10
	ECG11	Electrocardiogram 11
	ECG12	Electrocardiogram 12
	ECG13	Electrocardiogram 13
	ECG14	Electrocardiogram 14
	ECG15	Electrocardiogram 15
Medical	LFPulse	Waveform of the low frequency pulse electrotherapy
	Tens1	Waveform 1 of the nerve stimulation electrotherapy
	Tens2	Waveform 2 of the nerve stimulation electrotherapy
	Tens3	Waveform 3 of the nerve stimulation electrotherapy
AutoElec		
Auto	Ignition	Ignition waveform of the automotive motor
	ISO16750-2 SP	Automotive starting profile with ringing
	ISO16750-2 VR	Automotive supply voltage profile for resetting
	ISO7637-2 TP1	Automotive transients due to disconnects
	ISO7637-2 TP2A	Automotive transients due to inductance in wiring
	ISO7637-2 TP2B	Automotive transients due ignition switching off
	ISO7637-2 TP3A	Automotive transients due to switching
	ISO7637-2 TP3B	Automotive transients due to switching
	ISO7637-2 TP4	Automotive supply profile during starting
	ISO7637-2 TP5A	Automotive transients due to battery disconnect
ISO7637-2 TP5B	Automotive transients due to battery disconnect	
Maths		
MF	Airy	Airy function
	Besselj	Bessell function
	Bessely	Besselll function
	Cubic	Cubic function
	Dirichlet	Dirichlet function

	Erf	Error function
	Erfc	Complementary error function
	ErfcInv	Inverted complementary error function
	ErfInv	Inverted error function
	ExpFall	Exponential fall function
	ExpRise	Exponential rise function
	HaverSine	HaverSine function
	Laguerre	4-times Laguerre polynomial
	Legend	5-times Legend polynomial
	Versiera	Versiera
	ARB_X2	Square function
DF	Gauss	Gauss distribution
	Weibull	Weibull distribution
	LogNormal	Logarithmic Gaussian distribution
	Laplace	Laplace distribution
	Maxwell	Maxwell distribution
	Rayleigh	Rayleigh distribution
	Cauchy	Cauchy distribution function
TF	CosH	Hyperbolic cosine
	CosInt	Integral cosine
	Cot	Cotangent
	CotHCon	Concave hyperbolic cotangent
	CotHPro	Protuberant hyperbolic cotangent
	CscCon	Concave cosecant
	CscPro	Protuberant cosecant
	CscHCon	Concave hyperbolic cosecant
	CscHPro	Protuberant hyperbolic cosecant
	RecipCon	Concave reciprocal
	RecipPro	Protuberant reciprocal
	SecCon	Concave secant
	SecPro	Protuberant secant
	SecH	Hyperbolic secant
	SinH	Hyperbolic sine
	SinInt	Integral sine
	Sqrt	Square root
	Tan	Tangent
	TanH	Hyperbolic tangent
	AbsSine	Absolute value of sine
AbsSineHalf	Absolute value of half a sine	
ITF	ACos	Arc cosine
	ACosH	Arc hyperbolic cosine
	ACotCon	Concave arc cotangent
	ACotPro	Protuberant arc cotangent
	ACotHCon	Concave arc hyperbolic cotangent

	ACotHPro	Protuberant arc hyperbolic cotangent
	ACscCon	Concave arc cosecant
	ACscPro	Protuberant arc cosecant
	ACschCon	Concave arc hyperbolic cosecant
	ACschPro	Protuberant arc hyperbolic cosecant
	ASecCon	Concave arc secant
	ASecPro	Protuberant arc secant
	ASecH	Arc hyperbolic secant
	ASin	Arc Sinc
	ASinH	Arc hyperbolic sine
	ATan	Arc tangent
	ATanH	Arc hyperbolic tangent
WF	Bartlett	Bartlett window
	BarthannWin	Modified Bartlett-Hann window
	Blackman	Blackman window
	BlackmanH	BlackmanH window
	BohmanWin	Bohman window
	Boxcar	Rectangle window
	ChebWin	Chebyshev window
	FlatTopWin	Flat Top weighted window
	Hamming	Hamming window
	Hanning	Hanning window
	Kaiser	Kaiser window
	NuttallWin	Nuttall-defined minimum 4-term Blackman-Harris window
	ParzenWin	Parzen window
	TaylorWin	Taylor window
	Triang	Triangle window (Fejer window)
TukeyWin	Tukey (tapered cosine) window	

Stored Waveform

Select arbitrary waveforms stored in internal non-volatile memory (C Disk) or external memory (D Disk). Press **Arb** → **Select Wform** → **Stored Wforms** to enter the Store/Recall Interface and the **Store** key at the front panel is illuminated. At this time, please select and read the desired arbitrary waveform file. For more details, please refer to “**Store and Recall**”. Waveform data in volatile memory will be changed after the file is read. Now press **Arb** to return to arbitrary waveform setting interface.

Volatile Waveform

Press **Arb** → **Select Wform** → **Volatile Wform** to select arbitrary waveform currently stored in the volatile memory. If there is no waveform data in volatile memory currently, this menu would be unavailable. At this time, you can fill up the volatile memory through the methods below.

1. Fill up the volatile memory with the waveform currently edited through **Edit Wform**.
2. Press **Arb** → **Edit Wform** → **Data Src** to select "CH1 Arb", "CH2 Arb" or "Vol". Then copy the currently selected arbitrary waveform of CH1 or CH2 or the waveform of the other channel's volatile memory to the volatile memory of the currently selected channel.

When "Volatile Wform" is selected, users can edit the volatile waveform using the **Edit Wform** menu. The new waveform data will overwrite the previous data in the volatile memory. You can also save the new volatile waveform in non-volatile memory.

To Edit Arbitrary Waveform

DG1000Z allows users to edit the waveform in the volatile memory of the channel currently selected. If there is no waveform data in the volatile memory currently, the system will automatically create 8 (under sample rate edit mode) or 8192 (under period edit mode) data points whose voltage are low level. You can also copy the arbitrary waveform currently selected of CH1 or CH2 or the waveform of the other channel's volatile memory to the volatile memory of the channel currently selected for editing.

Press **Arb** → **Edit Wform** to enter the waveform editing interface.

1. Edit Mode

Press **Mode** and select "Sample Rate" or "Period" mode.

1) In Sample Rate Edit Mode:

- The range of the sample rate is from 1 μ Sa/s to 60MSa/s and the default is 20MSa/s. For the setting method, refer to "**Output Mode and Sample Rate**".
- The range of the points (denoted by **Sa**) is from 8 to 16384 (namely 16k) and the default is 8. Users can respectively select the number of the **Sa** points and set voltage for each point.

2) In Period Edit Mode:

- The range of the period is from 50ns to 1Ms and the default is 1ms. For the setting method, refer to "**To Set Frequency/Period**".
- The range of the points (denoted by **Sa**) is from 8 to 8192 (namely 8k) and the default is 8192. The period currently set is divided equally to 8191 (8192-1), namely 8192 points. Each point corresponds a data point (0s corresponds to the first data point and the current period corresponds to the 8192th point). Users can respectively select the number of the **Sa** points and set voltage for each point. The voltage values of all other points remain low level.

2. High Level

It refers to the highest voltage that can be set when editing waveform. Press **HiLevel**, input the desired value using the numeric keyboard, and select the desired unit (the units available are V and mV) from the pop-up menu. The high level must be higher than the "Low Level" currently set and lower than or equal to +10V (HighZ).

3. Low Level

It refers to the lowest voltage that can be set when editing waveform. Press **LoLevel**, input the desired value using the numeric keyboard, and select the desired unit (the units available are V and mV) from the pop-up menu. The low level must be higher than or equal to -10V (HighZ) and lower than the "High Level" currently set.

4. Points (denoted by Sa)

In sample rate edit mode, the range of the points is from 8 to 16384 (16K). In period edit mode, the range of the points is from 8 to 8192 (8K). Press **Points**, input the desired value using the numeric keyboard, and select **OK** from the pop-up menu. At this time, the prompt message (modify arbitrary waveform points, original data will be lost) is displayed and you need to select **OK** again.

Note: when the points is modified, the original waveform data in volatile memory will be lost.

5. Data Source

Press **Data Src** to select "CH1 Arb", "CH2 Arb" or "Volatile". You can copy the arbitrary waveform currently selected by CH1 or CH2 or the volatile waveform of the other channel to the volatile memory of the currently selected channel and edit them.

6. Insert Waveform

Insert the specified waveform at the specified position of the waveform edited currently. Press this menu key to enter "Insert Waveform" interface.

- **Insert Position**

Set the start position for inserting the waveform. Press this menu key and input the desired value using the numeric keyboard or direction keys and knob. The range is from 1 to **Sa** and **Sa** indicates current total points. For example, if the insert position set is 7, the instrument will insert a waveform from the seventh point.

- **Insert Way**

Select the insert way between "Insert" and "Rewrite".

In insert way, when inserting the selected waveform at the specified insert position, the original waveform data will be moved behind the inserted waveform.

In rewrite way, the inserted waveform will overwrite the original waveform from the specified insert position.

- **Cycles**
Set the cycles of the inserted waveform. The range is from 1 to 16 and the default is 1. The each cycle's points of the inserted waveform is fixed at 1024.
- **Select Waveform**
Select the waveform to be inserted. You can select the basic waveforms (Sine, Square, Ramp, Pulse and Noise) or the built-in waveforms (160 types optional, refer to Table 2-2).

Note: when inserting a waveform, you should first set the insert position, insert way and cycles, and then select the desired waveform types (because the insert operation will be executed immediately after the desired waveform is selected).

7. Edit Points

Sa is used to denote the points currently set. In point edit mode, users can select the number of the first **Sa** waveform point and set the voltage for each point. Press this menu key to enter the "Edit Points" interface.

- **Edit Points**
Select the number (the range is from 1 to **Sa**) of the point to be edited and input the desired value using numeric keyboard or direction keys and knob.
- **Voltage**
Set the voltage of the current point (the units available are mV and V). The range is limited by the current "High Level" and "Low Level".
- **Insert**
Insert a point at the point currently edited. The voltage of the inserted point is the same as the voltage value currently set and the original waveform data are moved behind the inserted point. At this time, the number of the points increases by 1.
- **Delete**
Delete the current point. At this time, the number of the points decreases by 1.
- **Move Position**
Modify the voltage of the specified point to the voltage of the point currently edited and set the voltage of the current point to low level.

Press **Move Pos** and input the number (the range is from 1 to **Sa**) of the point to move to before pressing **OK**. You can also rotate the knob to select the number of the point to move to after pressing **Move Pos**.

- **Preview**
Preview the waveform currently edited.

8. Edit Block

In block edit mode, users only need to edit the numbers of the start and end point as well as the corresponding voltages. The generator will automatically calculate the voltage of each point between the start point and end point. Press this menu key to enter the “Edit Block” interface.

- **X1**
Set the number of the start point of the block. X1 should be less than or equal to X2 and less than the points currently set.
- **Y1**
Set the voltage (the units available are mV and V) of the start point of the block. The range is limited by the current “High Level” and “Low Level”.
- **X2**
Set the number of the end point of the block. X2 should be less than or equal to the points currently set and greater than or equal to X1.
- **Y2**
Set the voltage (the units available are mV and V) of the end point of the block. The range is limited by the current “High Level” and “Low Level”.
- **Excute**
Automatically edit the points between the start point and end point according to the current settings.
- **Delete**
Delete X1 and the points between X1 and X2.

Note: this operation is available only when the difference of the points currently set and the points to be deleted is greater than or equal to 8.

9. Save

When the editing is finished, press **Save** to enter the store and recall interface and the backlight of **Store** turns on. At this time, you can store the arbitrary waveform edited in internal non-volatile memory (C Disk) or external memory (D Disk). For the store method, refer to “**Store and Recall**”.

To Output Harmonic

DG1000Z can be used as a harmonic generator to output harmonic with specified order, amplitude and phase. It is usually used in the test of harmonic detector device or harmonic filter device. This section introduces how to configure the generator to output harmonic.

Overview

According to Fourier transform, time domain waveform is the superposition of a series of sine waveforms as shown in the equation below:

$$f(t) = A_1 \sin(2\pi f_1 t + \varphi_1) + A_2 \sin(2\pi f_2 t + \varphi_2) + A_3 \sin(2\pi f_3 t + \varphi_3) + \dots$$

Generally, component with f_1 frequency is called fundamental waveform, f_1 is fundamental waveform frequency, A_1 is fundamental waveform amplitude, φ_1 is fundamental waveform phase. The frequencies of the other components (called harmonics) are all integral multiples of the fundamental waveform frequency. Components whose frequencies are odd multiples of the fundamental waveform frequency are called odd harmonics and components whose frequencies are even multiples of the fundamental waveform frequency are called even harmonics.

DG1000Z can output up to 8th harmonic. After selecting CH1 or CH2, press **Sine** → **Harm** to select "On" and press **Harmonic Para** to enter the harmonic setting menu. You can set the type of harmonic, specify the highest order of harmonic and set the amplitude and phase of each order of harmonic. If you want to set various parameters of fundamental waveform, please set the parameters of Sine.

After finishing harmonic parameters setting, press **Output1** and the backlight turns on, the instrument outputs the specified harmonic from the corresponding output terminal.

To Set Fundamental Waveform Parameters

DG1000Z allows users to set various fundamental waveform parameters such as frequency, period, amplitude, DC offset voltage, high level, low level and start phase. It also supports align phase operation. Please refer to introductions in “**To Output Basic Waveform**” to set above fundamental waveform parameters.

To Set Harmonic Order

The highest order of harmonic output from DG1000Z can not be greater than this setting value.

After entering the harmonic setting menu, press **Order** (at this point, “Order” on the screen is highlighted) and use the numeric keyboard or knob to input the desired harmonic order.

- The range is limited by the maximum output frequency of the instrument and current fundamental waveform frequency.
- Range: **2 to maximum output frequency of the instrument ÷ current fundamental waveform frequency** (must be integer).
- The maximum is 8.

To Select Harmonic Type

DG1000Z can output even harmonic, odd harmonic, all orders of harmonic and user-defined orders of harmonic. After entering the harmonic setting menu, press **Type** to select the desired harmonic type.

- 1. Even**
Press this key and the instrument will output fundamental waveform and even harmonics.
- 2. Odd**
Press this key and the instrument would output fundamental waveform and odd harmonics.
- 3. All**
Press this key and the instrument would output fundamental waveform and all the harmonics in order.
- 4. User**
Press this key and the instrument would output the user-defined orders of harmonics. The highest order is 8.

8 bits binary data is used to represent the output status of the 8 orders of harmonics respectively, wherein, 1 represents enabling the output of the corresponding harmonic and 0 represents disabling the output of the corresponding harmonic. Users only need to use the numeric keyboard to modify the value of each data bit (note: the leftmost bit representing fundamental waveform is always X and can not be modified). For example, set the 8 bits data to X001 0001, thus fundamental waveform and 4th and 8th orders of harmonics are output.

Note: the actual harmonics output is determined by the harmonic order and harmonic type currently specified.

To Set Harmonic Amplitude

After entering the harmonic setting menu, press **Harmonic Ampl** to set the amplitude of each order of harmonic.

- 1) **SN:** press this softkey to select the sequence number of the harmonic to be set.
- 2) **Harmonic Ampl:** press this softkey to set the amplitude of the harmonic selected. Use the numeric keyboard to input the amplitude value and then select the desired unit from the pop-up menu. The units available are Vpp, mVpp, Vrms, mVrms and dBm (invalid in HighZ).

To Set Harmonic Phase

After entering the harmonic setting menu, press **Harmonic Phase** to set the phase of each order of harmonic.

1. **SN:** press this softkey to select the sequence number of the harmonic to be set.
2. **Harmonic Phase:** press this softkey to set the phase of the harmonic selected. Use the numeric keyboard or the direction keys and knob to input the phase value and then select the unit "°" from the pop-up menu.

Example: To Output Harmonic

This section introduces how to output 2th order of harmonic (harmonic amplitude: 2Vpp, harmonic phase: 30°) and 4th orders of harmonic (harmonic amplitude: 1Vpp, harmonic phase: 50°) from the **[CH1]** connector. The fundamental waveform is the default sine of the instrument and the harmonic order is 5.

1. **To Select Output Channel:** Press **CH1|CH2** to select CH1. At this time, the border of the channel status bar is displayed in yellow.
2. **To Set Fundamental Waveform Parameters:** In this example, various parameters of the fundamental waveform take the default values. You can also refer to the introduction in **"To Output Basic Waveform"** to set various fundamental waveform parameters such as frequency/period, amplitude/high level, offset/low level and start phase.
3. **To Enable Harmonic Function:** Press **Sine** → **Harm** to select "On" and press **Harmonic Para** to enter the harmonic setting menu.
4. **To Set Harmonic Order:** In the harmonic setting menu, press **Order** and use the numeric keyboard to input 5 before pressing **OK**.
5. **To Select Harmonic Type:** In the harmonic setting menu, press **Type** to select even harmonic.
6. **To Select Harmonic Amplitude:** In the harmonic setting menu, press **Harmonic Ampl** to successively set the amplitude of 2th and 4th orders of harmonic.
 - 1) Press **SN**, input 2 (the harmonic sequence number) using the numeric keyboard, and press **OK**.
 - 2) Press **Harmonic Ampl**, input 2 (the value of the amplitude) using the numeric keyboard, and select the unit "Vpp" from the pop-up units menu.
 - 3) Refer to step 1 and 2 to set the amplitude of the 4th order harmonic to 1Vpp.
7. **To Set Harmonic Phase:** In the harmonic setting menu, press **Harmonic Phase** to set the phase of 2th and 4th orders of harmonic successively.
 - 1) Press **SN**, input 2 (the harmonic sequence number) using the numeric keyboard, and press **OK**.
 - 2) Press **Harmonic Phase**, input 30 (the value of the phase) using the numeric keyboard, and select the unit "°" from the pop-up units menu.
 - 3) Refer to step 1 and 2 to set the phase of the 4th order harmonic to 50°.

8. **To Enable the Output:** Press **Output1** and the backlight turns on. The fundamental waveform, 2th and 4th order of harmonics will be outputted from the **[CH1]** connector according to the current configuration.
9. **To Observe the Output Waveform:** Connet the CH1 of the DG1000Z to an oscilloscope using BNC connect cable. The observed waveform from the oscilloscope is shown in the figure below.



Figure 2-6 Harmonic

Modulation

DG1000Z can output modulated waveform from a single channel or from two channels at the same time. Modulation is the process of modifying certain parameters (such as amplitude, frequency, phase and etc.) of the carrier waveform signal according to the change of the modulating signal. The carrier waveform can be Sine, Square, Ramp, Arbitrary waveform (except DC) or Pulse (only in PWM). The modulating waveform can be from internal or external modulation source. DG1000Z supports AM, FM, PM, ASK, FSK, PSK and PWM.

Amplitude Modulation (AM)

For amplitude modulation (AM), the amplitude of the carrier waveform varies with the instantaneous voltage of the modulating waveform.

To Select AM Modulation

Press **Mod** → **Type** → **AM** to enable AM function. When **Mod** is enabled, **Sweep** or **Burst** will be disabled automatically (if enabled currently).

To Select Carrier Waveform Shape

AM carrier waveform could be Sine, Square, Ramp or Arbitrary waveform (except DC). The default is Sine.

- Press the front panel key **Sine**, **Square**, **Ramp** or **Arb** (you need to press **Select Wform** in the arbitrary waveform setting interface to select the desired arbitrary waveform) to select the desired carrier waveform shape.
- Pulse, Noise and DC could not be used as carrier waveform.

To Set Carrier Waveform Parameters

The different settings of various parameters (frequency, amplitude, DC offset, start phase and etc.) of the carrier waveform will influence the AM modulated waveform. For different carrier waveform shape, the ranges of the various parameters are different (the ranges are related to the model of the instrument used and the carrier waveform currently selected. See "**Specifications**" for details). For all carrier waveform shapes, the default values are 1kHz frequency, 5Vpp amplitude, 0V_{DC} offset and 0° start phase.

- When the carrier waveform currently selected is Sine, Square or Ramp, please refer to the introduction in "**To Output Basic Waveform**" to set the parameters of the carrier waveform currently selected.

- When the carrier waveform currently selected is arbitrary waveform, please refer to the introduction in **“To Output Arbitrary Waveform”** to set the parameters of the carrier waveform currently selected.

To Select Modulation Source

DG1000Z can accept modulating waveform from internal or external modulation source. Press **Mod** → **Source** to select “Int” or “Ext” modulation source.

1. Internal Source

When internal modulation source is selected, press **Shape** to select Sine, Square, Triangle, UpRamp, DnRamp, Noise or Arb as modulating waveform. The default is Sine.

- Square: 50% duty cycle
- Triangle: 50% symmetry
- UpRamp: 100% symmetry
- DnRamp: 0% symmetry
- Arb: the arbitrary waveform selected of the current channel

Note: noise can be used as modulating waveform but can not be used as carrier waveform.

2. External Source

When external modulation source is selected, **Shape** and **AM Freq** will be grayed out and disabled. The generator accepts the external modulating signal from the **[CH1/Sync/Ext Mod/Trig/FSK]** connector at the rear panel. At this time, amplitude of the modulated waveform is controlled by the ± 5 V signal level of the connector. For example, if the modulation depth is set to 100%, the output amplitude will be the maximum when the modulating signal is +5V and the minimum when the modulating signal is -5V.

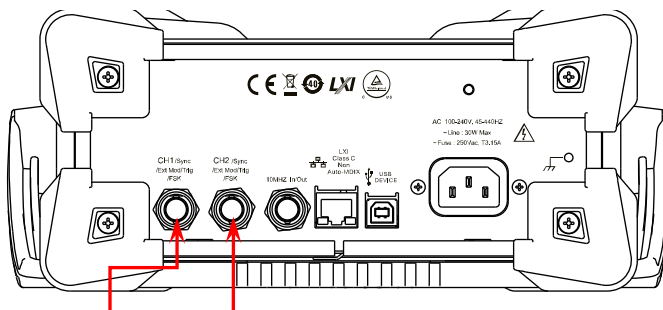

[CH1/Sync/Ext Mod/Trig/FSK]

[CH2/Sync/Ext Mod/Trig/FSK]

KEY POINTS:**How to realize the intermodulation between dual channels?**

The following example takes the output signal of CH2 as the modulating waveform.

1. Connect the CH2 output terminal to **[CH1/Sync/Ext Mod/Trig/FSK]** connector at the rear panel using the dual BNC connect cable.
2. Select CH1 and press **Mod** to select the desired modulation type as well as set the corresponding parameters before selecting external modulation source.
3. Select CH2 and select the desired modulating waveform and set the corresponding parameters.
4. Press **Output1** to enable the output of CH1.

To Set Modulating Waveform Frequency

When internal modulation source is selected, press **AM Freq** to set the modulating waveform frequency.

- Input the desired frequency value using the numeric keyboard or direction keys and knob.
- The modulating waveform frequency ranges from 2mHz to 1MHz, and the default value is 100Hz.

Note: when external modulation source is selected, this menu will be grayed out and disabled.

To Set Modulation Depth

Modulation depth expressed as a percentage indicates the amplitude variation degree. The AM modulation depth ranges from 0% to 120%. Press **AM Depth** to set AM modulation depth.

- In 0% modulation, the output amplitude is half of the carrier waveform amplitude.
- In 100% modulation, the output amplitude is equal to carrier waveform amplitude.
- In >100% modulation, the output amplitude of the instrument would not exceed 10Vpp (50Ω load).

When external modulation source is selected, the output amplitude of the instrument is controlled by the $\pm 5V$ signal level of the **[CH1/Sync/Ext Mod/Trig/FSK]** connector at the rear panel. For example, if the modulation depth is set to 100%, the output amplitude will be the maximum when the modulating signal is +5V and the minimum when the modulating signal is -5V.

Carrier Waveform Suppression

DG1000Z supports the normal amplitude modulation and double sideband suppressed carrier (DSB-SC) amplitude modulation. In the normal amplitude modulation, the modulated waveform contains carrier waveform components. Because carrier waveform components carry no information, the modulation is less efficient. In order to improve the modulation efficiency, the carrier waveform components are suppressed on the base of the normal amplitude modulation. At this time, all modulated waveform carry information. This method is called double sideband suppressed carrier modulation. By default, DG1000Z works in the normal amplitude modulation and users can enable the double sideband suppressed carrier modulation through pressing the menu key **DSSC** and selecting "On".

Frequency Modulation (FM)

For frequency modulation (FM), the frequency of the carrier waveform varies with the instantaneous voltage of the modulating waveform.

To Select FM Modulation

Press **Mod** → **Type** → **FM** to enable FM function. When **Mod** is enabled, **Sweep** or **Burst** will be disabled automatically (if enabled currently).

To Select Carrier Waveform Shape

FM carrier waveform could be Sine, Square, Ramp or Arbitrary waveform (except DC). The default is Sine.

- Press the front panel key **Sine**, **Square**, **Ramp** or **Arb** (you need to press **Select Wform** in the arbitrary waveform setting interface to select the desired arbitrary waveform) to select the desired carrier waveform shape.
- Pulse, Noise and DC could not be used as carrier waveform.

To Set Carrier Waveform Parameters

The different settings of various parameters (frequency, amplitude, DC offset, start phase and etc.) of the carrier waveform will influence the FM modulated waveform. For different carrier waveform shape, the ranges of the various parameters are different (the ranges are related to the model of the instrument used and the carrier waveform currently selected. See "**Specifications**" for details). For all carrier waveform shapes, the default values are 1kHz frequency, 5Vpp amplitude, 0V_{DC} offset and 0° start phase.

- When the carrier waveform currently selected is Sine, Square or Ramp, please refer to the introduction in "**To Output Basic Waveform**" to set the parameters of the carrier waveform currently selected.
- When the carrier waveform currently selected is arbitrary waveform, please refer to the introduction in "**To Output Arbitrary Waveform**" to set the parameters of the carrier waveform currently selected.

To Select Modulation Source

DG1000Z can accept modulating waveform from internal or external modulation source. Press **Mod** → **Source** to select "Int" or "Ext" modulation source.

1. Internal Source

When internal modulation source is selected, press **Shape** to select Sine, Square, Triangle, UpRamp, DnRamp, Noise or Arb as modulating waveform. The default is Sine.

- Square: 50% duty cycle
- Triangle: 50% symmetry
- UpRamp: 100% symmetry
- DnRamp: 0% symmetry
- Arb: the arbitrary waveform selected of the current channel

Note: noise can be used as modulating waveform but can not be used as carrier waveform.

2. External Source

When external modulation source is selected, **Shape** and **FM Freq** will be grayed out and disabled. The generator accepts the external modulating signal from the **[CH1/Sync/Ext Mod/Trig/FSK]** connector at the rear panel. At this time, frequency deviation of the modulated waveform is controlled by the ± 5 V signal level of the connector. For example, if the frequency deviation is set to 1 kHz, +5V signal level corresponds to a 1kHz increase of frequency and -5V signal level corresponds to a 1kHz decrease of frequency.

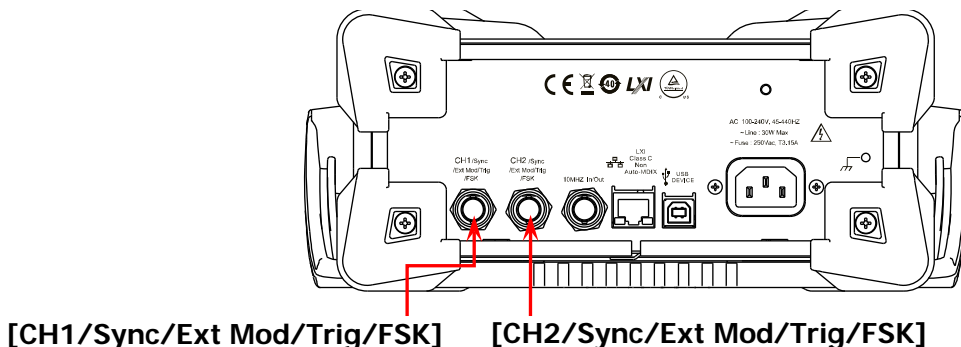

To Set Modulating Waveform Frequency

When internal modulation source is selected, press **FM Freq** to set the modulating waveform frequency.

- Input the desired frequency value using the numeric keyboard or direction keys and knob.
- The modulating waveform frequency ranges from 2mHz to 1MHz, and the default value is 100Hz.

Note: when external modulation source is selected, this menu will be grayed out and disabled.

To Set Frequency Deviation

Frequency deviation is the deviation of the modulating waveform frequency relative to the carrier frequency. Press **FM Dev** to set the FM frequency deviation.

- Frequency deviation must be lower than or equal to the carrier frequency.
- The sum of frequency deviation and carrier frequency must be lower than or equal to the sum of the current carrier frequency upper limit and 1kHz.

Note: if Sine is selected currently as the carrier waveform, the carrier amplitude will be limited at 2Vpp when the sum of the frequency deviation and the carrier frequency is greater than the frequency upper limit of the current carrier.

When external modulation source is selected, the frequency deviation is controlled by the $\pm 5V$ signal level of the **[CH1/Sync/Ext Mod/Trig/FSK]** connector at the rear panel. Positive signal level corresponds to frequency increase and negative signal level corresponds to frequency decrease. For example, if the frequency deviation is set to 1 kHz, +5V signal level corresponds to a 1kHz increase of frequency and -5V signal level corresponds to a 1kHz decrease of frequency.

Phase Modulation (PM)

For phase modulation (PM), the phase of the carrier waveform varies with the instantaneous voltage of the modulating waveform.

To Select PM Modulation

Press **Mod** → **Type** → **PM** to enable PM function. When **Mod** is enabled, **Sweep** or **Burst** will be disabled automatically (if enabled currently).

To Select Carrier Waveform Shape

PM carrier waveform could be Sine, Square, Ramp or Arbitrary waveform (except DC). The default is Sine.

- Press the front panel key **Sine**, **Square**, **Ramp** or **Arb** (you need to press **Select Wform** in the arbitrary waveform setting interface to select the desired arbitrary waveform) to select the desired carrier waveform shape.
- Pulse, Noise and DC could not be used as carrier waveform.

To Set Carrier Waveform Parameters

The different settings of various parameters (frequency, amplitude, DC offset, etc.) of the carrier waveform will influence the PM modulated waveform. For different carrier waveform shape, the ranges of the various parameters are different (the ranges are related to the model of the instrument used and the carrier waveform currently selected. See “**Specifications**” for details). For all carrier waveform shapes, the default values are 1kHz frequency, 5Vpp amplitude and 0V_{DC} offset.

- When the carrier waveform currently selected is Sine, Square or Ramp, please refer to the introduction in “**To Output Basic Waveform**” to set the parameters of the carrier waveform currently selected.
- When the carrier waveform currently selected is arbitrary waveform, please refer to the introduction in “**To Output Arbitrary Waveform**” to set the parameters of the carrier waveform currently selected.

Note: when PM function is enabled, the start phase of the carrier waveform can not be set.

To Select Modulation Source

DG1000Z can accept modulating waveform from internal or external modulation source. Press **Mod** → **Source** to select “Int” or “Ext” modulation source.

1. Internal Source

When internal modulation source is selected, press **Shape** to select Sine, Square, Triangle, UpRamp, DnRamp, Noise or Arb as modulating waveform. The default is Sine.

- Square: 50% duty cycle
- Triangle: 50% symmetry
- UpRamp: 100% symmetry
- DnRamp: 0% symmetry
- Arb: the arbitrary waveform selected of the current channel

Note: noise can be used as modulating waveform but can not be used as carrier waveform.

2. External Source

When external modulation source is selected, **Shape** and **PM Freq** will be grayed out and disabled. The generator accepts the external modulating signal from the **[CH1/Sync/Ext Mod/Trig/FSK]** connector at the rear panel. At this time, phase deviation of the modulated waveform is controlled by the $\pm 5V$ signal level of the connector. For example, if the phase deviation is set to 180° , +5V signal level corresponds to a 180° phase variation. The lower the external signal level, the less deviation would be generated.

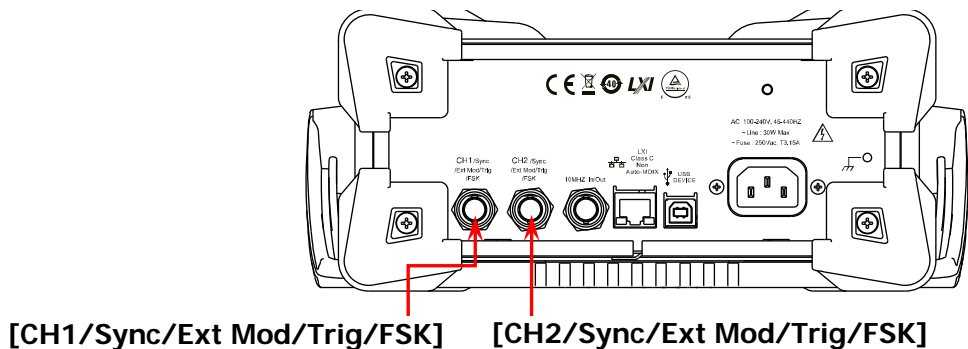

To Set Modulating Waveform Frequency

When internal modulation source is selected, press **PM Freq** to set the modulating waveform frequency.

- Input the desired frequency value using the numeric keyboard or direction keys and knob.
- The modulating waveform frequency ranges from 2mHz to 1MHz, and the default value is 100Hz.

Note: when external modulation source is selected, this menu will be grayed out and disabled.

To Set Phase Deviation

Phase deviation is the deviation of the modulating waveform phase relative to the carrier waveform phase. Press **PM Dev** to set the PM phase deviation.

- Use the numeric keyboard or direction keys and knob to input the desired phase value.
- The range of phase deviation is from 0° to 360° and the default is 90°.

When external modulation source is selected, the phase deviation is controlled by the $\pm 5V$ signal level from the **[CH1/Sync/Ext Mod/Trig/FSK]** connector at the rear panel. For example, if the phase deviation is set to 180°, +5V signal level corresponds to a 180° phase variation. The lower the external signal level, the less deviation would be generated.

Amplitude Shift Keying (ASK)

When using ASK (Amplitude Shift Keying), you can configure the generator to “shift” its output amplitude between two preset amplitude values (“carrier amplitude” and “modulating amplitude”).

To Select ASK Modulation

Press **Mod** → **Type** → **ASK** to enable ASK function. When **Mod** is enabled, **Sweep** or **Burst** will be disabled automatically (if enabled currently).

To Select Carrier Waveform Shape

PM carrier waveform could be Sine, Square, Ramp or Arbitrary waveform (except DC). The default is Sine.

- Press the front panel key **Sine**, **Square**, **Ramp** or **Arb** (you need to press **Select Wform** in the arbitrary waveform setting interface to select the desired arbitrary waveform) to select the desired carrier waveform shape.
- Pulse, Noise and DC could not be used as carrier waveform.

To Set Carrier Waveform Parameters

The different settings of various parameters (frequency, amplitude, DC offset and etc.) of the carrier waveform will influence the ASK modulated waveform. For different carrier waveform shape, the ranges of the various parameters are different (the ranges are related to the model of the instrument used and the carrier waveform currently selected. See “**Specifications**” for details). For all carrier waveform shapes, the default values are 1kHz frequency, 5Vpp amplitude and 0V_{DC} offset.

- When the carrier waveform currently selected is Sine, Square or Ramp, please refer to the introduction in “**To Output Basic Waveform**” to set the parameters of the carrier waveform currently selected.
- When the carrier waveform currently selected is arbitrary waveform, please refer to the introduction in “**To Output Arbitrary Waveform**” to set the parameters of the carrier waveform currently selected.

To Select Modulation Source

Press **Mod** → **Source** to select “Int” or “Ext” modulation source.

1. Internal Source

When internal source is selected, the modulating waveform is set as a Square with 50% duty cycle, and the frequency at which the output amplitude “shifts” between “carrier amplitude” and “modulating amplitude” is determined by “ASK Rate”.

2. External Source

When external source is selected, the generator accepts the external modulating signal from the **[CH1/Sync/Ext Mod/Trig/FSK]** connector at the rear panel.

Note: for the **[CH1/Sync/Ext Mod/Trig/FSK]** connector, controlling ASK modulation externally is different from controlling AM/FM/PM modulations externally. In ASK modulation, you can set the modulating polarity.

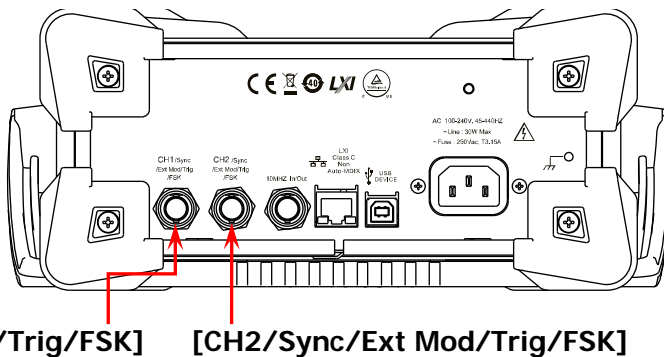

To Set Modulating Rate

When internal source is selected, press **ASK Rate** to set the rate at which the output amplitude shifts between “carrier amplitude” and “modulating amplitude”.

- Use the numeric keyboard or direction keys and knob to input the desired frequency value.
- The frequency range is from 2mHz to 1MHz and the default is 100Hz.

Note: when external modulation source is selected, this menu will be grayed out and disabled.

To Set Modulating Amplitude

Press **ASK Ampl** to set the modulating amplitude.

- Use the numeric keyboard or direction keys and knob to input the desired amplitude value.
- The range of amplitude (HighZ) is from 0 to 10Vpp and the default is 2Vpp.

To Set Modulating Polarity

Press **Polarity** to select the "Pos" or "Neg" polarity of the modulating waveform to control the output amplitude.

In internal modulation, set the polarity to "Pos" and the generator would output the lower of the carrier amplitude and modulating amplitude when the modulating waveform is logic low level and output the greater when the modulating waveform is logic high level. The situation is the opposite when the polarity is set to "Neg".

In external modulation, set the polarity to "Pos" and the generator would output the lower of the carrier amplitude and modulating amplitude when the external input signal is logic low level and output the greater when the external input signal is logic high level. The situation is the opposite when the polarity is set to "Neg".

Frequency Shift Keying (FSK)

When FSK (Frequency Shift Keying) modulation is selected, you can configure the generator to “shift” its output frequency between two preset frequencies (“carrier frequency” and “hop frequency”).

To Select FSK Modulation

Press **Mod** → **Type** → **FSK** to enable FSK function. When **Mod** is enabled, **Sweep** or **Burst** will be automatically disabled (if enabled currently).

To Select Carrier Waveform Shape

FSK carrier waveform could be Sine, Square, Ramp or Arbitrary waveform (except DC). The default is Sine.

- Press the front panel key **Sine**, **Square**, **Ramp** or **Arb** (you need to press **Select Wform** in the arbitrary waveform setting interface to select the desired arbitrary waveform) to select the desired carrier waveform shape.
- Pulse, Noise and DC could not be used as carrier waveform.

To Set Carrier Waveform Parameters

The different settings of various parameters (frequency, amplitude, DC offset, start phase and etc.) of the carrier waveform will influence the FSK modulated waveform. For different carrier waveform shape, the ranges of the various parameters are different (the ranges are related to the model of the instrument used and the carrier waveform currently selected. See “**Specifications**” for details). For all carrier waveform shapes, the default values are 1kHz frequency, 5Vpp amplitude, 0V_{DC} offset and 0° start phase.

- When the carrier waveform currently selected is Sine, Square or Ramp, please refer to the introduction in “**To Output Basic Waveform**” to set the parameters of the carrier waveform currently selected.
- When the carrier waveform currently selected is arbitrary waveform, please refer to the introduction in “**To Output Arbitrary Waveform**” to set the parameters of the carrier waveform currently selected.

To Select Modulation Source

Press **Mod** → **Source** to select “Int” or “Ext” modulation source.

1. Internal Source

When internal source is selected, the modulating waveform is set as a Square with 50% duty cycle, and the frequency at which the output frequency “shifts” between “carrier frequency” and “hop frequency” is determined by “FSK Rate”.

2. External Source

When external source is selected, the generator accepts the external modulating signal from the **[CH1/Sync/Ext Mod/Trig/FSK]** connector at the rear panel.

Note: for the **[CH1/Sync/Ext Mod/Trig/FSK]** connector, controlling FSK modulation externally is different from controlling AM/FM/PM modulations externally. In FSK modulation, you can set the modulating polarity.

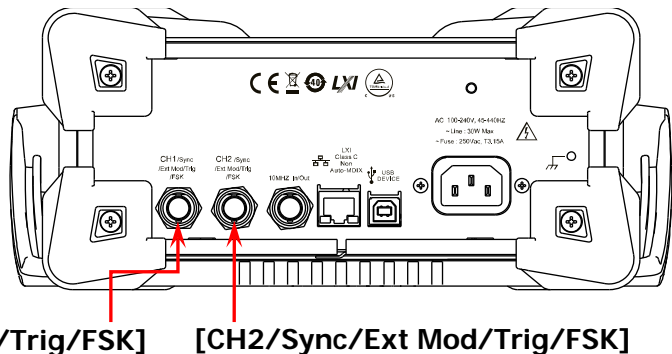

To Set Modulating Rate

When internal source is selected, press **FSK Rate** to set the frequency at which the output frequency shifts between “carrier frequency” and “hop frequency”.

- Use the numeric keyboard or direction keys and knob to input the desired frequency value.
- The frequency range is from 2mHz to 1MHz and the default is 100Hz.

Note: when external modulation source is selected, this menu will be grayed out and disabled.

To Set Hop Frequency

Hop frequency is the modulating frequency. The range of hop frequency depends on the carrier waveform currently selected. Press **HopFreq** to highlight it and input the desired frequency value using the numeric keyboard or direction keys and knob.

- Sine: 1 μ Hz to 60MHz
- Square: 1 μ Hz to 25MHz
- Ramp: 1 μ Hz to 1MHz
- Arb: 1 μ Hz to 20MHz

To Set Modulating Polarity

Press **Polarity** to select the "Pos" or "Neg" polarity of the modulating waveform to control the output frequency.

In internal modulation, set the polarity to "Pos" and the generator would output the carrier frequency when the modulating waveform is logic low level and output the hop frequency when the modulating waveform is logic high level. The situation is the opposite when the polarity is set to "Neg".

In external modulation, set the polarity to "Pos" and the generator would output the carrier frequency when the external input signal is logic low level and output the hop frequency when the external input signal is logic high level. The situation is the opposite when the polarity is set to "Neg".

Phase Shift Keying (PSK)

When PSK (Phase Shift Keying) modulation is selected, you can configure the generator to “shift” its output phase between two preset phase values (“carrier phase” and “modulating phase”).

To Select PSK Modulation

Press **Mod** → **Type** → **PSK** to enable PSK function. When **Mod** is enabled, **Sweep** or **Burst** will be automatically disabled (if enabled currently).

To Select Carrier Waveform Shape

PSK carrier waveform could be Sine, Square, Ramp or Arbitrary waveform (except DC). The default is Sine.

- Press the front panel key **Sine**, **Square**, **Ramp** or **Arb** (you need to press **Select Wform** in the arbitrary waveform setting interface to select the desired arbitrary waveform) to select the desired carrier waveform shape.
- Pulse, Noise and DC could not be used as carrier waveform.

To Set Carrier Waveform Parameters

The different settings of various parameters (frequency, amplitude, DC offset, start phase and etc.) of the carrier waveform will influence the PSK modulated waveform. For different carrier waveform shape, the ranges of the various parameters are different (the ranges are related to the model of the instrument used and the carrier waveform currently selected. See “**Specifications**” for details). For all carrier waveform shapes, the default values are 1kHz frequency, 5Vpp amplitude, 0V_{DC} offset and 0° start phase.

- When the carrier waveform currently selected is Sine, Square or Ramp, please refer to the introduction in “**To Output Basic Waveform**” to set the parameters of the carrier waveform currently selected.
- When the carrier waveform currently selected is arbitrary waveform, please refer to the introduction in “**To Output Arbitrary Waveform**” to set the parameters of the carrier waveform currently selected.

To Select Modulation Source

Press **Mod** → **Source** to select “Int” or “Ext” modulation source.

1. Internal Source

When internal source is selected, the modulating waveform is set as a Square with 50% duty cycle, and the frequency at which the output phase “shifts” between “carrier phase” and “modulating phase” is determined by “PSK Rate”.

2. External Source

When external source is selected, the generator accepts the external modulating signal from the **[CH1/Sync/Ext Mod/Trig/FSK]** connector at the rear panel.

Note: for the **[CH1/Sync/Ext Mod/Trig/FSK]** connector, controlling PSK modulation externally is different from controlling AM/FM/PM modulations externally. In PSK modulation, you can set the modulating polarity.

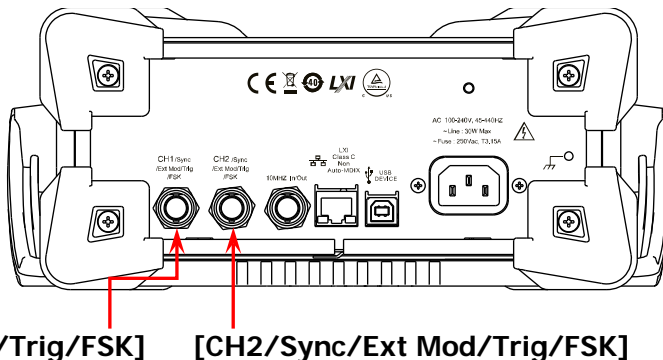

To Set Modulating Rate

When internal source is selected, press **PSK Rate** to set the frequency at which the output phase shifts between “carrier phase” and “hop phase”.

- Use the numeric keyboard or direction keys and knob to input the desired frequency value.
- The frequency range is from 2mHz to 1MHz and the default is 100Hz.

Note: when external modulation source is selected, this menu will be grayed out and disabled.

To Set Modulating Phase

Press **Phase** to set the modulating phase.

- Use the numeric keyboard or direction keys and knob to input the desired phase value.
- The phase range is from 0° to 360° and the default is 180°.

To Set Modulating Polarity

Press **Polarity** to select the “Pos” or “Neg” polarity of the modulating waveform to control the output phase.

In internal modulation, set the polarity to “Pos” and the generator would output the carrier phase when the modulating waveform is logic low level and output the modulating phase when the modulating waveform is logic high level. The situation is the opposite when the polarity is set to “Neg”.

In external modulation, set the polarity to “Pos” and the generator would output the carrier phase when the external input signal is logic low level and output the modulating phase when the external input signal is logic high level. The situation is the opposite when the polarity is set to “Neg”.

Pulse Width Modulation (PWM)

For PWM (Pulse Width Modulation), the pulse width of the carrier waveform varies with the instantaneous voltage of the modulating waveform.

To Select PWM Modulation

PWM can only be used to modulate pulse. To select PWM modulation, press **Pulse** at the front panel first and then press **Mod** to enable PWM function.

- If the **Pulse** function key has not been selected, PWM in **Type** menu is unavailable.
- When **Mod** is enabled but the modulation type is not PWM, pressing **Pulse** will select PWM automatically.
- When **Mod** is enabled, **Sweep** or **Burst** will be automatically disabled (if enabled currently).

To Select Carrier Waveform Shape

As mentioned before, PWM can only be used to modulate Pulse. To select Pulse waveform, press **Pulse** at the front panel.

To Set Carrier Waveform Parameters

The different settings of various parameters (frequency, amplitude, DC offset, pulse width, duty cycle and etc.) of the carrier waveform will influence the PWM modulated waveform. For all pulses, the ranges of the various parameters are different. And the default values are 1kHz frequency, 5Vpp amplitude, 0V_{DC} offset 500μs pulse width and 50% duty cycle.

Please refer to the introduction in “**To Output Basic Waveform**” to set the parameters of the carrier waveform.

To Select Modulation Source

Press **Mod** → **Source** to select “Int” or “Ext” modulation source.

1. Internal Source

When internal modulation source is selected, press **Shape** to select Sine, Square, Triangle, UpRamp, DnRamp, Noise or Arb as modulating waveform. The default is Sine.

- Square: 50% duty cycle
- Triangle: 50% symmetry
- UpRamp: 100% symmetry
- DnRamp: 0% symmetry
- Arb: the arbitrary waveform selected of the current channel

Note: noise can be used as modulating waveform but can not be used as carrier waveform.

2. External Source

When external modulation source is selected, **Shape** and **PWM Freq** will be grayed out and disabled. The generator accepts the external modulating signal from the **[CH1/Sync/Ext Mod/Trig/FSK]** connector at the rear panel. At this time, the “width deviation” or “duty cycle deviation” of the modulated waveform is controlled by the ± 5 V signal level of the connector. For example, if the width deviation is set to 10s, +5V signal level corresponds to a 10s width variation.

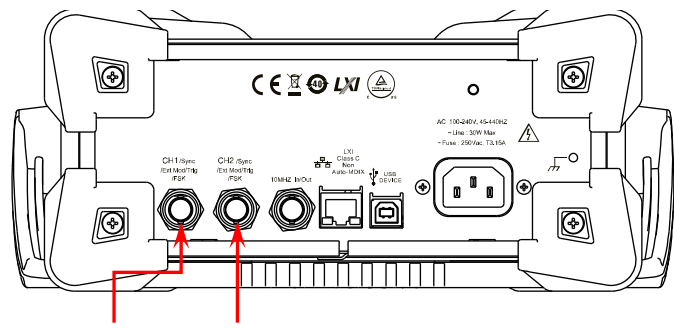

[CH1/Sync/Ext Mod/Trig/FSK]

[CH2/Sync/Ext Mod/Trig/FSK]

To Set Modulating Waveform Frequency

When internal modulation source is selected, press **PWM Freq** to set the frequency of the modulating waveform.

- Use the numeric keyboard or direction keys and knob to input the desired frequency value.
- The frequency range is from 2mHz to 1MHz and the default is 100Hz.

Note: when external modulation source is selected, this menu will be grayed out and disabled.

To Set Pulse Width/Duty Cycle Deviation

Press **Width DeV** (or **Duty Dev**) and input the desired value using the numeric keyboard or direction keys and knob.

- Width deviation represents the variation (the available units are ns, μ s, ms, s and ks) of the modulated waveform pulse width relative to the original pulse width.
The width deviation can not exceed the current pulse width.
The width deviation is limited by the minimum pulse width and current edge time setting.
- Duty cycle deviation represents the variation (in %) of the modulated waveform duty cycle relative to the original pulse duty cycle.
The duty cycle deviation can not exceed the current pulse duty cycle.
The duty cycle is limited by the minimum duty cycle and current edge time setting.

When external modulation source is selected, width deviation or duty cycle deviation is controlled by the $\pm 5V$ signal level of the **[CH1/Sync/Ext Mod/Trig/FSK]** connector at the rear panel. For example, if the width deviation is set to 10s, the +5V signal level corresponds to a 10s width variation.

Sweep

DG1000Z can output sweep from a single channel or from dual channels at the same time. In sweep mode, the generator outputs signal variably from the start frequency to stop frequency within the specified sweep time. DG1000Z supports linear, log and step sweep modes, allows users to set start hold, end hold and return time, supports internal, external or manual trigger source, and can generate sweep output for Sine, Square, Ramp and arbitrary waveform (except DC).

To Enable Sweep Function

Press **Sweep** at the front panel to enable the sweep function (the backlight of the key turns on), and **Mod** or **Burst** function will be automatically disabled (if currently enabled). The instrument will generate the sweep waveform from the corresponding channel (if currently turned on) according to the current configuration. You can also reset the sweep parameters. Please refer to the introduction in the following text for details.

Start Frequency and Stop Frequency

Start frequency and stop frequency are the upper and lower limits of the frequency for frequency sweep. The generator always sweeps from the start frequency to the stop frequency and then returns back to the start frequency.

- Start Frequency < Stop Frequency: the generator sweeps from low frequency to high frequency.
- Start Frequency > Stop Frequency: the generator sweeps from high frequency to low frequency.
- Start Frequency = Stop Frequency: the generator outputs with a fixed frequency.

When sweep mode is enabled, press **Start/Center** to highlight “**Start**”. Notice that the “**Stop**” in **Stop/Span** key will also be highlighted at the same time. Use the numeric keyboard or direction keys and knob to input the desired frequencies. By default, the start frequency is 100Hz and the stop frequency is 1kHz. Different sweep waveform corresponds to different start frequency and stop frequency range.

- Sine: 1μHz to 60MHz
- Square: 1μHz to 25MHz
- Ramp: 1μHz to 1MHz
- Arb: 1μHz to 20MHz

The generator will renewedly sweep (according to the current new configuration) from the specified “start frequency” after start or stop frequency is changed.

Center Frequency and Frequency Span

You can also set the frequency boundaries of frequency sweep through center frequency and frequency span.

- Center Frequency = (|Start Frequency + Stop Frequency|) / 2
- Frequency Span = Stop Frequency – Start Frequency

When sweep mode is enabled, press **Start/Center** to highlight “Center”. Notice that the “Span” in **Stop/Span** will also be highlighted at the same time. Use the numeric keyboard or direction keys and knob to enter the desired frequency values. By default, the center frequency is 550Hz and the frequency span is 900Hz. Different sweep waveform corresponds to different center frequency and frequency span range and the center frequency and frequency span are interrelative.

Define the minimum frequency of the waveform currently selected as F_{\min} , the maximum frequency as F_{\max} and $F_m = (F_{\min} + F_{\max}) / 2$.

- The range of center frequency is from F_{\min} to F_{\max} and the parameters for different waveforms are as follows.
Sine: 1 μ Hz to 60MHz
Square: 1 μ Hz to 25MHz
Ramp: 1 μ Hz to 1MHz
Arb: 1 μ Hz to 20MHz
- The range of frequency span is influenced by the center frequency.
Center frequency $< F_m$: the range is $\pm 2 \times (\text{center frequency} - F_{\min})$;
Center frequency $\geq F_m$: the range is $\pm 2 \times (F_{\max} - \text{center frequency})$.

Take sine as an example. F_{\min} is 1 μ Hz, F_{\max} is 60MHz and F_m is about 30MHz.

If the center frequency is 550Hz, the frequency span range is $\pm 2 \times (550\text{Hz} - 1\mu\text{Hz}) = \pm 1.099999998\text{kHz}$; if the center frequency is 55MHz, the frequency span range is $\pm 2 \times (60\text{MHz} - 55\text{MHz}) = \pm 10\text{MHz}$.

The generator will renewedly sweep (according to the current new configuration) from the specified “start frequency” after center frequency or frequency span is changed.

TIP:

In large-scale sweep, the amplitude characteristic of the output signal might change.

Sweep Type

DG1000Z provides **Linear**, **Log** and **Step** sweep types and the default is **Linear** sweep.

Linear Sweep

In linear sweep type, the output frequency of the instrument varies linearly in the way of “several Hertz per second”. The variation is controlled by “Start Frequency”, “Stop Frequency” and “Sweep Time”.

When **Sweep** is enabled, press **Type** to select “Linear”. A straight line is displayed on the waveform on the screen, indicating that the output frequency varies linearly.

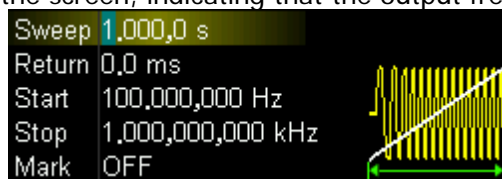

Figure 2-7 Linear Sweep

Log Sweep

In Log Sweep type, the output frequency of the instrument varies in a logarithmic fashion, that is, the output frequency changes in the way of “octave per second” or “decade per second”. The variation is controlled by “Start Frequency”, “Stop Frequency” and “Sweep Time”.

When Log Sweep is enabled, users could set the following parameter:

Start Frequency (F_{start}), Stop Frequency (F_{stop}) and Sweep Time (T_{sweep}).

The function prototype of Log Sweep:

$$F_{current} = P^T$$

$F_{current}$ is the instantaneous frequency of the current output. P and T could be expressed as shown below by the above-mentioned parameters:

$$P = 10^{\lg(F_{stop}/F_{start})/T_{sweep}}$$

$$T = t + \lg(F_{start})/\lg(P)$$

Wherein, t is the time from the start of the sweep and its range is from 0 to T_{sweep} .

When **Sweep** is enabled, press **Type** to select “Log”. An exponential function curve is displayed on the waveform on the screen, indicating that the output frequency changes in a logarithmic mode.

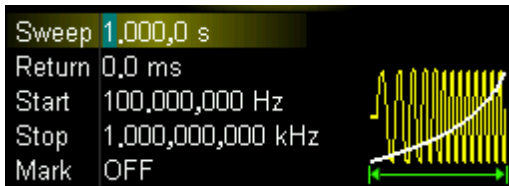

Figure 2-8 Log Sweep

Step Sweep

In Step Sweep type, the output frequency of the instrument “steps” from “Start Frequency” to “Stop Frequency”. The duration of the output signal on each frequency point is determined by “Sweep Time” and “Step Number”.

When **Sweep** is enabled, press **Type** to select “Step”. A step waveform is displayed on the waveform on the screen, indicating that the output frequency varies in “step”. At this point, press **2/2** to open the 2/2 menu page. Press **Step Num** and input the step number using the numeric keyboard or direction keys and knob. The default is 2 and the range is from 2 to 1024.

Note: in “Linear” and “Log” sweep modes, **Step Num** is grayed out and disabled.

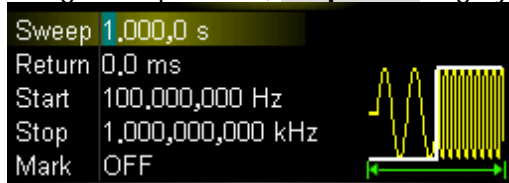

Figure 2-9 Step Sweep

Sweep Time

When **Sweep** is enabled, press **SweepTime** and use the numeric keyboard or knob to modify the sweep time. The default value is 1s and the available range is from 1ms to 500s. The generator will renewedly sweep and output from the specified “Start Frequency” once the sweep time is modified.

Return Time

Return time describes the time in which the output returns to “Start frequency” from “Stop Frequency” after the generator has swept from “Start Frequency” to “Stop Frequency” and stay within “Stop Hold” time.

When **Sweep** is enabled, press **ReturnTime** and use the numeric keyboard or direction keys and knob to modify the return time. The default value is 0s and the available range is from 0s to 500s.

The generator will renewedly sweep from the specified “Start Frequency” once the return time is modified.

Mark Frequency

The sync signal output from the [CH1/Sync/Ext Mod/Trig/FSK] connector (corresponds to the channel at the front panel) at the rear panel always changes from low level to high level at the start of each sweep. The sync signal changes from high level to low level at the center frequency point when “Mark” function is disabled or at the specified mark frequency point when “Mark” function is enabled.

When **Sweep** is enabled, press **Mark** to select “On” and use the numeric keyboard or direction keys and knob to modify the mark frequency. The default value is 550Hz and the available range is limited by “Start Frequency” and “Stop Frequency”.

The generator will renewedly sweep and output from the specified “Start Frequency” once the mark frequency is modified.

KEY POINTS:

For step sweep (the sweep points determined by the start frequency, stop frequency and step number respectively are $f_1, f_2, \dots, f_n, f_{n+1}, \dots$), if the mark frequency setting is one of the sweep points values, the sync signal is TTL high level at the start of the sweep and will change to low level at the mark frequency point. If the mark frequency setting is not any one of the sweep points values, the sync signal will change to low level at the sweep point which is closest to this mark frequency.

Start Hold

Start hold is the duration that the output signal outputs with the “Start Frequency” after the sweep starts. After the start hold, the generator will output with varying frequency according to the current sweep type.

When **Sweep** is enabled, press **Start Hold** and use the numeric keyboard or direction keys and knob to change the Start Hold. The default value is 0s and the available range is from 0s to 500s.

The generator will renewedly sweep and output from the specified “Start Frequency” once the Start Hold is changed.

Stop Hold

Stop Hold is the duration that the output signal still outputs with the “Stop Frequency” after the generator has swept from the “Start Frequency” to the “Stop Frequency”.

When **Sweep** is enabled, press **Stop Hold** and use the numeric keyboard or direction keys and knob to change the stop hold. The default value is 0s and the available range is from 0s to 500s.

The generator will renewedly sweep and output from the specified “start frequency” once the End Hold is changed.

Sweep Trigger Source

The sweep trigger source could be internal, external or manual. The generator will generate a sweep output when a trigger signal is received and then wait for the next trigger source. When **Sweep** is enabled, press **Trigger** → **Source** to select “Int”, “Ext” or “Manual”. The default is “Int”.

1. Internal Trigger

The generator outputs continuous sweep waveform when internal trigger is selected. The trigger period is determined by the specified sweep time, return time, start hold and stop hold times.

Press **TrigOut** to select “Leading” or “Trailing” and the **[CH1/Sync/Ext Mod/Trig/FSK]** connector at the rear panel will output trigger signal with specified edge.

2. External Trigger

The generator accepts the trigger signal inputted from the **[CH1/Sync/Ext Mod/Trig/FSK]** connector at the rear panel when external trigger is selected. A sweep will be generated once the connector gets a TTL pulse with specified polarity. To set the TTL pulse polarity, press **SlopeIn** to select “Leading” or “Trailing”. The default is “Leading”.

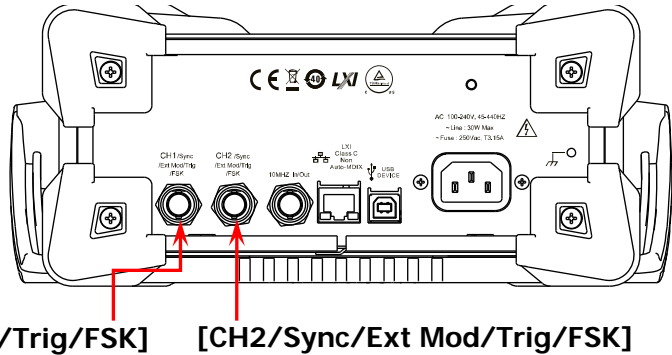

3. Manual Trigger

A sweep will be generated from the corresponding channel once you press **Trigger** when manual trigger is selected.

Note: the menu key **Trigger** is valid when the “Manual Trigger” is selected and the output of the corresponding channel is enabled.

Press **TrigOut** to select “Leading” or “Trailing” and the **[CH1/Sync/Ext Mod/Trig/FSK]** connector at the rear panel will output trigger signal with specified edge.

KEY POINTS:

1. When “Int” or “Manual” trigger is selected, press **Sweep** → **Trigger** → **TrigOut** to select “Off”, “Leading” or “Trailing”.
 - 1) When “Off” is selected, the **[CH1/Sync/Ext Mod/Trig/FSK]** connector at the rear panel will output the sync signal which changes from low level to high level at the start of each sweep and returns to low level at center frequency point or at the specified mark frequency point.
 - 2) When “Leading” is selected, the **[CH1/Sync/Ext Mod/Trig/FSK]** connector at the rear panel will output the trigger signal which is the same as the sync signal. The trigger signal changes from low level to high level at the start of each sweep (that is, enable the trigger at the leading edge) and returns to low level at center frequency point or at the specified mark frequency point.
 - 3) When “Trailing” is selected, the **[CH1/Sync/Ext Mod/Trig/FSK]** connector at the rear panel will output the trigger signal which changes from high level to low level at the start of each sweep (that is, enable the trigger at the trailing edge) and returns to high level at center frequency point or at the specified mark frequency point.

2. When "Ext" trigger is selected, press **Sweep** → **Trigger** → **TrigOut** to select "Leading" or "Trailing". The **[CH1/Sync/Ext Mod/Trig/FSK]** connector at the rear panel is used as the input terminal of external trigger signal. The instrument generates a sweep at the leading edge of the inputted signal when leading edge is selected or at the trailing edge of the inputted signal when trailing edge is selected.

Burst

DG1000Z can output waveform with specified number of cycles (called Burst) from a single channel or from dual channels at the same time. DG1000Z supports control of burst output by internal, manual or external trigger source; supports three kinds of burst types including N cycle, infinite and gated. The generator can generate burst using Sine, Square, Ramp, Pulse, Noise (only for gated burst) or arbitrary waveform (except DC).

To Enable Burst Function

Press **Burst** at the front panel to enable Burst function (the backlight of the key turns on), and **Mod** or **Sweep** function will be automatically disabled (if currently enabled). The generator will output burst waveform from the corresponding channel (if currently turned on) according to the current configuration. You can also reset the burst function menu. Please refer to the introduction in the following text for details.

Burst Type

DG1000Z can output three types of bursts including N cycle, infinite and gated. The default is N cycle.

Table 2-3 Relations among burst type, trigger source and carrier waveform

Burst Type	Trigger Source	Carrier Waveform
N Cycle	Int/Ext/Manual	Sine, Square, Ramp, Pulse, Arbitrary waveform (except DC)
Infinite	Ext/Manual	Sine, Square, Ramp, Pulse, Arbitrary waveform (except DC)
Gated	Ext	Sine, Square, Ramp, Pulse, Noise, Arbitrary waveform (except DC)

N Cycle Burst

In N Cycle mode, the generator will output waveform with specified number of cycles after receiving trigger signal. Waveform functions that support N cycle burst include Sine, Square, Ramp, Pulse and arbitrary waveform (except DC).

When **Burst** is enabled, press **Type** to select "Ncycle". The "Cycles" is highlighted on the screen and could be edited. At this point, use the numeric keyboard or direction keys and knob to change the Cycles. The default is 1 and the range is from 1 to 1 000 000 (external or manual trigger) or 1 to 500 000 (internal trigger).

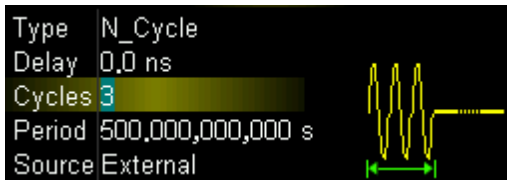

Figure 2-10 N Cycle Burst

For N cycle burst, "Int", "Ext" or "Manual" trigger source could be used. Besides, you can also set the "Burst Period" (internal trigger), "Delay", "SlopeIn" (external trigger) and "TrigOut" (internal and manual trigger).

Infinite Burst

In Infinite mode, the cycle number of the waveform is set as an infinite value. The generator outputs a continuous waveform after receiving trigger signal. Waveform functions that support infinite burst include Sine, Square, Ramp, Pulse and arbitrary waveform (except DC).

When **Burst** is enabled, press **Type** to select "Infinite" and the instrument will set the trigger source to "Manual" automatically. An infinite cycle burst sketch will appear on the screen.

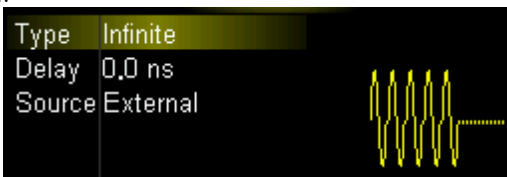

Figure 2-11 Infinite Burst

For infinite burst, "Ext" or "Manual" trigger source could be used. Besides, users can set the "Delay", "SlopeIn" (external trigger) and "TrigOut" (manual trigger).

Gated Burst

In Gated Burst Mode, the generator controls the waveform output according to the external signal level from the [CH1/Sync/Ext Mod/Trig/FSK] connector at the rear panel. Waveform functions which support gated burst are Sine, Square, Ramp, Pulse, Noise and arbitrary waveforms (except DC).

When **Burst** is enabled, press **Type** to select "Gated" and then press **Polarity** to set the gated polarity as "Pos" (or "Neg"). The generator outputs burst waveform only when the gated signal is positive (or negative).

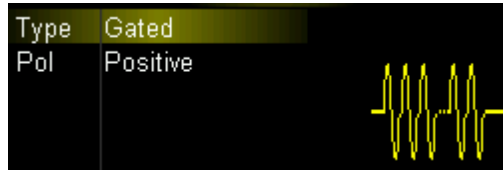

Figure 2-12 Gated Burst

When the gated signal is “True”, the generator outputs a continuous waveform. When the gated signal is “False”, the generator first completes the output of the current period and then stops. For Noise waveform, the output will stop immediately once the gated signal becomes “False”.

Gated Burst could only be triggered by “Ext” trigger source.

Burst Period

Burst period is only available for N cycle burst in internal trigger and is defined as the time from the start of a burst to the start of the next one.

- Burst Period $\geq 2\mu\text{s} + \text{waveform period} \times \text{number of bursts}$. Here, waveform period is the period of burst function (such as Sine and Square).
- If the burst period currently set is too short, the generator will increase this period automatically to allow the output of the specified number of cycles.

When **Burst** is enabled, press **Type** → “NCycle” → **Trigger** → **Source** → “Int” to select N cycle burst in internal trigger. Press  to return to the previous menu and then press **Burst Period** to input the desired period using the numeric keyboard or direction keys and knob. The default is 10ms and the range is from 2 μs to 500s.

Gated Polarity

Gated polarity is only available in gated burst mode. The instrument outputs burst when the gated signal of the **[CH1/Sync/Ext Mod/Trig/FSK]** connector at the rear panel is “High Level” or “Low Level”.

When **Burst** is enabled, press **Type** → “Gated” → **Polarity** to select “Pos” or “Neg”. The default is “Pos”.

Burst Delay

Burst delay is only available for N cycle and infinite burst mode. It is defined as the time from when the generator receives the trigger signal to starts to output the N Cycle (or Infinite) burst.

When **Burst** is enabled, press **Type** → “NCycle” or “Infinite”, and then press **Delay** and use the numeric keyboard or knob to input the desired delay time. The delay is no less than 0s and no greater than 100s and the default is 0s.

Burst Trigger Source

Burst trigger source could be internal, external or manual. The generator will generate a burst output when a trigger signal is received and then wait for the next trigger. When **Burst** is enabled, press **Trigger** → **Source** to select “Int”, “Ext” or “Manual”. The default is “Int”.

1. Internal Trigger

When internal trigger is selected, the generator can only output N cycle burst and the burst frequency is determined by the “Burst Period”.

Press **TrigOut** to select “Leading” or “Trailing” and the **[CH1/Sync/Ext Mod/Trig/FSK]** connector at the rear panel will output the trigger signal with specified edge.

2. External Trigger

When external trigger is selected, the generator can output N cycle, infinite or gated burst. The generator accepts the trigger signal from the **[CH1/Sync/Ext Mod/Trig/FSK]** connector at the rear panel. A burst will be generated once the connector receives a TTL pulse with specified polarity. To set the TTL pulse polarity, press **SlopeIn** to select “Leading” or “Trailing”. The default setting is “Leading”.

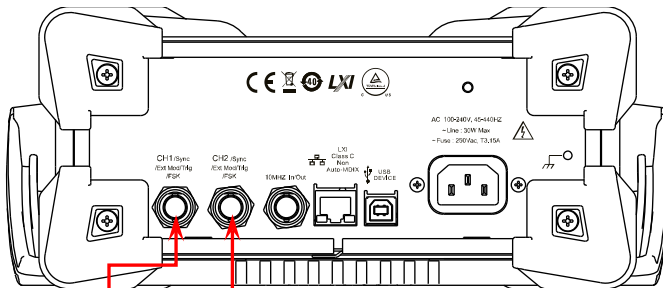

[CH1/Sync/Ext Mod/Trig/FSK]

[CH2/Sync/Ext Mod/Trig/FSK]

3. Manual Trigger

When manual trigger is selected, the generator can output infinite or gated burst. A burst will be generated from the corresponding channel (if currently turned on) once you press **Trigger**. If the corresponding channel is not turned on, **Trigger** will be grayed out and disabled.

Press **TrigOut** to select “Leading” or “Trailing” and the **[CH1/Sync/Ext Mod/Trig/FSK]** connector at the rear panel will output the trigger signal with specified edge.

Counter

DG1000Z provides a counter which can measure various parameters (such as frequency, period, duty cycle, positive pulse width and negative pulse width) of external input signal and support statistic of measurement results. When the statistic function is enabled, the instrument calculates the maximum, minimum, average and standard deviation of the measurement values automatically and displays the variation tendency of the measurement values in "Digital" or "Curve" mode. In addition, the dual channels can still output normally when the counter is enabled.

To Enable the Counter

Press **Counter** at the front panel (the backlight turns on and the left indicator flickers) to enable counter function and enter counter setting interface.

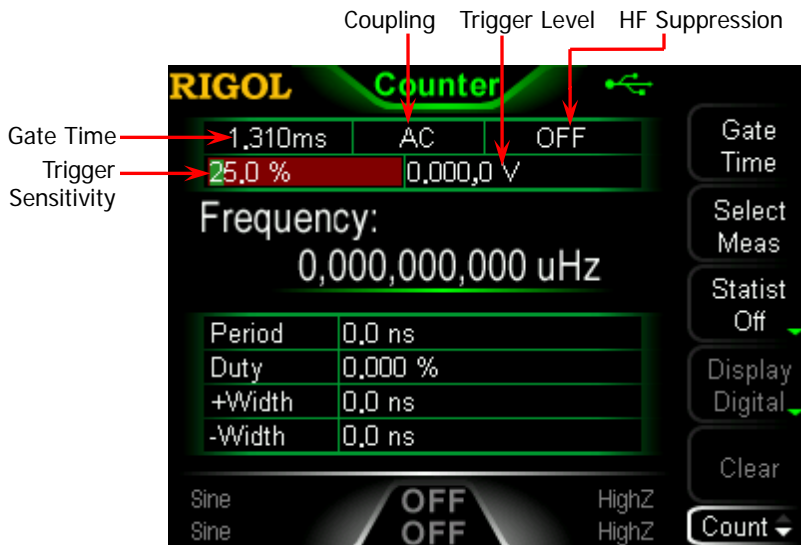

Figure 2-13 Counter Parameter Setting Interface

If the counter is currently turned on and the screen displays the counter interface, press **Counter** again to disable counter function. If the counter is currently turned on and the screen displays interfaces other than the counter interface, press **Counter** again to switch to the counter interface.

Note: when the counter is enabled, the CH2 sync output will be disabled.

To Set the Counter

You need to configure appropriate parameters for the counter.

1. Gate Time

Press **Gate Time** to set the gate time of the measurement system and the default is "1.310ms".

1ms	1.310ms
10ms	10.48ms
100ms	166.7ms
1s	1.342s
10s	10.73s
>10s	>10s

2. To Select the Parameters to be Measured

Press **Select Meas** to select the type of parameter to be measured by the counter. The counter can measure the following parameters: frequency, period, duty cycle, positive pulse width and negative pulse width. The default is "frequency".

3. Statistic Function

Press **Statist** to enable or disable statistic function. When the statistic function is enabled, the instrument calculates the maximum, minimum, average and standard deviation of the measurement values automatically and displays the variation tendency of the measurement values in "Digital" or "Curve" mode.

1) To Select Display Mode

After the statistic function is enabled, press **Display** to set the display mode of the statistic results to "Digital" or "Curve", as shown in Figure 2-14 and Figure 2-15.

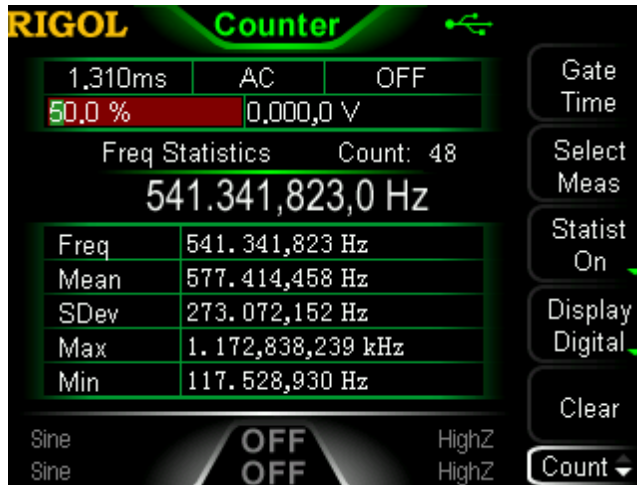

Figure 2-14 Statistic Results Interface (In "Digital" Display Mode)

Note: when the statistic function is disabled, **Display** is grayed out and disabled.

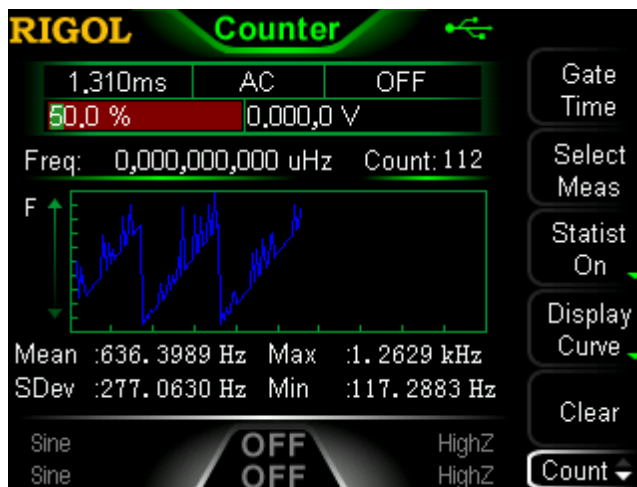

Figure 2-15 Statistic Results Interface (In "Curve" Display Mode)

2) To clear the statistic results

Press **Clear** to clear the current statistic result.

Note: when the statistic function is disabled, **Clear** is grayed out and disabled.

4. Trigger Sensitivity

Set the trigger sensitivity of the measurement system. The default is 25% and the range available is from 0% to 100%. Press **TrigSens** and use the numeric keyboard to input the desired value and select the unit “%” from the pop-up menu.

5. Trigger Level

Set the trigger level of the measurement system. The system triggers and gets the measurement readings when the input signal reaches the specified trigger level. The default is 0V and the range available is from -2.5V to 2.5V. Press **TrigLevel** and use the numeric keyboard to input the desired value and select the desired unit (V or mV) from the pop-up menu.

6. Coupling

Set the coupling mode of the input signal to “AC” or “DC” and the default is “AC”.

7. High-Frequency Suppression

High-frequency suppression can be used to filter out the high-frequency components and improve the measurement accuracy in low-frequency signal measurement. Press **HFSuppre** to enable or disable the high-frequency suppression function.

Note: enable high-frequency suppression when low-frequency signal with lower than 250kHz frequency is measured to filter out the high-frequency noise interference; disable high-frequency suppression when high-frequency signal with greater than 250kHz frequency is measured and the maximum input frequency can be 200MHz.

8. Auto

When **Auto** is pressed, the instrument will select an appropriate gate time automatically according to the characteristics of the signal to be measured. “AUTO” is displayed on the gate time area of the counter interface.

9. Running State

Pressing **State** can control the running state of the counter. When **Counter** at the front panel is pressed, the counter enters “Run” state automatically and continuously measures the input signal according to the current configuration. Press **State** and the counter first enters “Single” state and then enters “Stop” state after finishing the current measurement.

When the counter enters “Stop” state, each time **Single** is pressed, the counter executes one measurement.

Store and Recall

DG1000Z can store the current instrument state and user-defined arbitrary waveform data in internal or external memory and recall them when needed. DG1000Z also could interconnect with **RIGOL** oscilloscope which supports USB-TMC seamlessly and rebuilt and output the waveform data collected by the oscilloscope losslessly.

Storage System

DG1000Z can store the current instrument state and user-defined arbitrary waveform data in internal or external memory and recall them when needed. DG1000Z provides an internal non-volatile memory (C Disk) and an external memory (D Disk).

- 1. C Disk:** provide 10 storage locations for state files and 10 storage locations for arbitrary waveform files. Users can store instrument states and arbitrary waveform files (created by users or downloaded via remote commands) to C Disk and copy the files in USB storage device to C Disk. .
- 2. D Disk:** available when USB storage device is detected by the USB Host interface at the front panel. Users can store state files and arbitrary waveform files to D Disk and the number of the files can be stored is determined by the storage space of USB storage device. The Txt files, Csv files and Bmp files stored in the USB storage device can also be readed.

Press **Store** (the key backlight goes on) at the front panel to enable the Store/Recall function and open the Store/Recall interface as shown in the figure below.

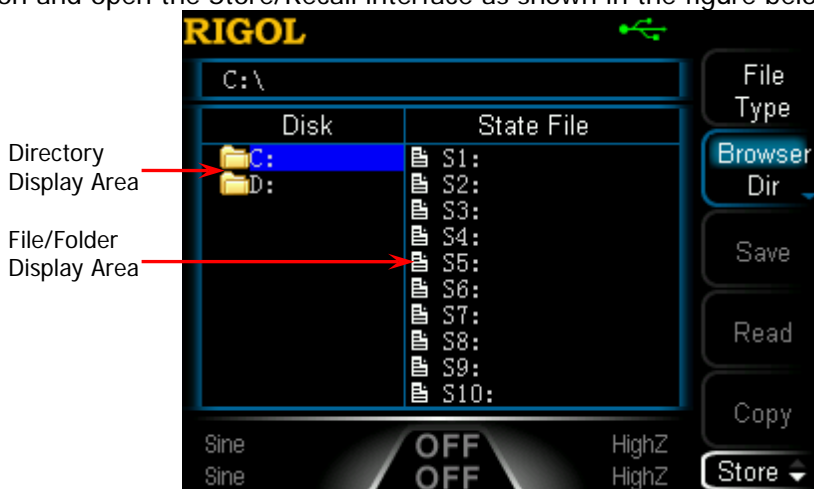

Figure 2-16 Store and Recall Interface

Note: DG1000Z can only identify files of which filenames consist of Chinese characters, English letters, number and underscore. If other characters are used to name the file or folder, the name might be displayed in the store and recall interface abnormally.

File Type

Press **Store** → **File Type** to select the desired file type. The file types available include State File, Arb File, Txt File, Csv File, Bmp File and All File.

1. State File

Store the instrument state in internal or external memory in *“*.RSF”* format. At most 10 instrument states can be stored in internal memory.

The state file stored includes waveforms selected, frequency, amplitude, DC offset, duty cycle, symmetry, phase and modulation, sweep, burst parameters used of the two channels and counter parameters as well as utility parameters and system parameters under the Utility menu.

2. Arb File

Store the user-defined arbitrary waveform in internal or external memory in *“*.RAF”* format. At most 10 arbitrary files can be stored in internal memory.

In arbitrary waveform file, the voltage values corresponding to each waveform point are stored in binary data format. In sample rate edit mode, if the points is set to **Sa**, the arbitrary waveform file only contains **Sa** points of which the voltage all are user-set values. In period edit mode, if the points is set to **Sa**, the voltage of the first **Sa** points are user-set values and the voltage from the (**Sa**+1)th point to the 8192th point are low level. The voltage value of each point takes 2 bytes (16 bits). The lower 14 bits are used to represent voltage and the higher 2 bits are unused. Therefore the format of binary data is from 0x0000 to 0x3FFF. Wherein, 0x0000 corresponds to the low level of the arbitrary waveform and 0x3FFF corresponds to the high level of the arbitrary waveform.

The stored arbitrary waveforms can be read by each model of DG1000Z series. Besides, the arbitrary waveforms stored in USB storage device can be opened and edited by data editing tools (such as WinHex or UltraEdit etc.) via computer.

```

00 20 00 00 EB 0B EB 0B EE 0B EE 0B EE 0B EE 0B ;
FO 0B FO 0B FO 0B FO 0B FO 0B FO 0B FO 0B FO 0B ;
FO 0B FO 0B EE 0B EE 0B EE 0B EE 0B EC 0B EC 0B ;
EB 0B EB 0B E7 0B E7 0B E6 0B E6 0B E2 0B E2 0B ;
E1 0B E1 0B DE 0B DE 0B D9 0B D9 0B D7 0B D7 0B ;
D2 0B D2 0B CD 0B CD 0B C8 0B C8 0B C5 0B C5 0B ;
BE 0B BE 0B B9 0B B9 0B B4 0B B4 0B AF 0B AF 0B ;
A8 0B A8 0B A3 0B A3 0B 9D 0B 9D 0B 96 0B 96 0B ;
90 0B 90 0B 89 0B 89 0B 82 0B 82 0B 7C 0B 7C 0B ;
77 0B 77 0B 6E 0B 6E 0B 68 0B 68 0B 61 0B 61 0B ;
5B 0B 5B 0B 54 0B 54 0B 4D 0B 4D 0B 47 0B 47 0B ;
40 0B 40 0B 39 0B 39 0B 34 0B 34 0B 2E 0B 2E 0B ;
29 0B 29 0B 22 0B 22 0B 1D 0B 1D 0B 17 0B 17 0B ;
13 0B 13 0B 0D 0B 0D 0B 08 0B 08 0B 04 0B 04 0B .

```

3. Txt File

Read the Txt files stored in external memory. The data of each line (can not be longer than 64 characters) is considered as an arbitrary waveform point and the data of all lines in the file are normalized to form an arbitrary waveform. The arbitrary waveform is stored in volatile memory. The instrument will enter the **Arb** interface automatically when the “Read” operation is finished.

Note: only when D Disk is selected, this menu is available.

4. Csv File

Read the Csv files in external memory. The instrument will enter the **Arb** interface automatically when the “Read” operation is finished. The arbitrary waveform is stored in volatile memory.

Note: only when D Disk is selected, this menu is available.

5. Bmp File

Browse the bitmap files in “*.BMP” format in the current directory. The Bmp files are mainly used to customize the start-up interface. Users need to press **Utility** → **System** → **Display** → **Custom GUI** → **Open File** to browse the Bmp files in the current directory and select the Bmp file meeting the requirement. Please refer to the introduction in “**Display Set**” for details.

Note: only when D Disk is selected, this menu is available.

6. All File

Display all files and folders in the currently selected directory. When this menu is selected, the store operation is unavailable.

Browser Type

Press **Store** → **Browser** to switch between “Dir” and “File”. Use the knob to select the desired directory or file.

- Dir: when this type is selected, use the knob to switch between C Disk and D Disk (when USB storage device is inserted).
- File: when this type is selected, use the knob to switch files or folders under the current directory.

File Operation

When “File” is selected as the browser type, users can perform a series of operations on files including Save, Read, Copy, Paste, Delete and New Folder.

Save

1. To Select File Type

Follow the introduction in “File Type” to select the type of files to be saved as. Only state file and arb file can be saved locally. If the current file is “Arb File”, press **Arb** → **Edit Wform** → **Save** to save it.

2. To Open the Filename Input Interface

Press **Browser** to select “File” and then press **Save** to enter the filename input interface as shown in the figure below.



Figure 2-17 Filename Input Interface (English)

3. To Input Filename

Press **IME** to select “Chinese” or “English”. The length of the file or folder name is limited within 9 characters.

- English Input (include number input):
Press **+/-** on the numeric keyboard at the front panel to switch between uppercase and lowercase.

Use the knob to select the desired character from the virtual soft keyboard, then press **Select** to select the character and the character selected would be displayed in the “Filename Input Area”. Use the same method to input all the characters needed. You can press **Delete** to delete the character at the cursor currently in the “Filename Input Area”.

- Chinese Input:
Press **+/-** on the numeric keyboard at the front panel to switch to lowercase.

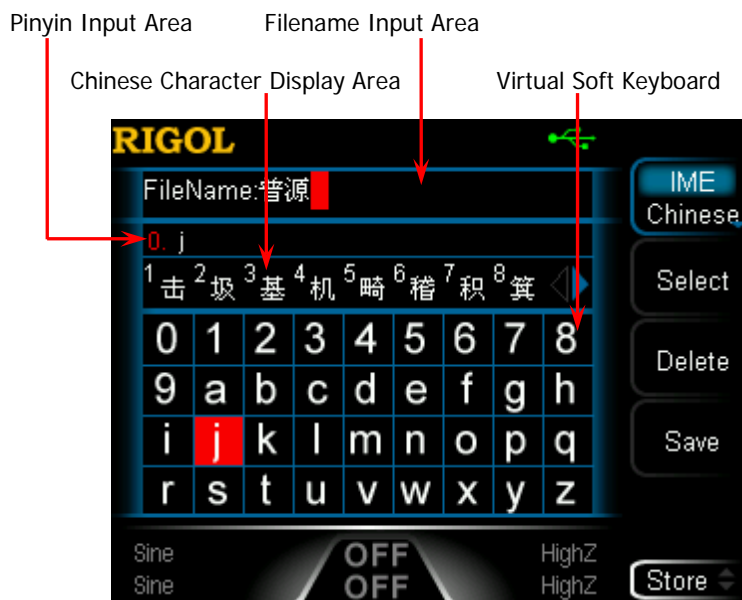

Figure 2-18 Filename Input Area (Chinese)

Use the knob to select the desired character from the “virtual soft keyboard”, then press **Select** to select the character and the character selected would be displayed in the “Pinyin Input Area”. After inputting the pinyin of a Chinese character, use the numeric keyboard to select the No. (in the “Chinese Character Display Area”) of the desired Chinese character (if the desired Chinese character is not currently displayed, use the direction key to open the next page) and the Chinese character selected would be displayed in the “Filename Input Area”. Use the same method to input all Chinese characters needed. You can also press **Delete** to first delete the

character in the “Pinyin Input Area” and then delete the Chinese character at the cursor currently in the “Filename Input Area”.

4. To Save File

After finishing inputting filename in the filename input interface, press **Save**, the generator will save the file under the currently selected directory with the specified filename and file type.

Read

1. To Select File Type

Follow the introduction in “File Type” to select the type of file to be read. For C Disk, only state file and arb file can be read. For D Disk, files of all types can be read. If you need to select “Bmp File”, press **Utility** → **System** → **Display** → **Custom GUI** → **Open File** to read the desired bitmap file.

2. To Select the File to be Read

Set **Browser** to “Dir” and use the knob to select the directory in which the file to be read is stored. Then set **Browser** to “File” and use the knob to select the file to be read.

3. To Read File

Press **Read**, the generator will read the currently selected file and display corresponding prompt message when the file is read successfully.

Copy and Paste

1. To Select the File to be Copied

Set **Browser** to “Dir” and use the knob to select the directory in which the file to be copied is stored. Then set **Browser** to “File”, and use the knob to select the file to be copied.

2. To Copy File

Press **Copy**, the generator will copy the file currently selected.

3. To Select Paste Destination

- When copying file from C Disk to D Disk, set **Browser** to “Dir” and use the knob to select D Disk directory.
- When copying file from D Disk to C Disk, set **Browser** to “Dir” and use the knob to select C Disk directory. And then you need to set **Browser** to “File” and use the knob to select the location of the currently copied file to be placed.

4. To Paste File

Press **Paste**, the generator will paste the copied file in the directory which the current cursor is in and display corresponding prompt message after finishing the paste operation.

Delete

1. To Select File or Folder to be Deleted

Set **Browser** to "Dir" and use the knob to select the directory in which the file or folder to be deleted is stored. Then set **Browser** to "File", and use the knob to select the file or folder to be deleted.

2. To Delete File or Folder

Press **Delete** and the generator will delete the currently selected file or folder (empty folder).

New Folder

DG1000Z allows users to create new folders in external memory. Please first insert a USB storage device and make sure that it is identified by the instrument.

1. To Select Memory

In Store/Recall interface, set **Browser** to "Dir" and use the knob to select "D disk".

2. New Directory

Set **Browser** to "File" and press **New Folder** to enter the folder name input interface (same as shown in Figure 2-17 or Figure 2-18).

Note: when "C Disk" is selected, this menu is unavailable.

3. To Input Folder Name

Input the name of the new folder following the introduction in "**Save**".

4. To Save Folder

After finishing inputting the name of the new folder in the folder name input interface, press **Save** and the generator will create a new empty folder under the current directory.

Seamless Interconnection with Oscilloscope

DG1000Z could interconnect with **RIGOL** oscilloscope which supports USB-TMC seamlessly and rebuilt and output the waveform data collected by the oscilloscope losslessly. The connection method between the instruments is as shown in the figure below.

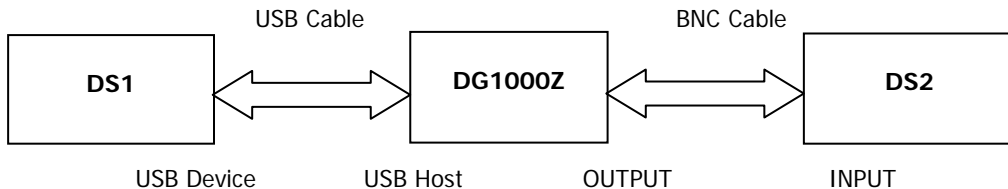

Operation Method:

1. Make sure that the measured signal is displayed steadily on the screen of DS1.
2. Connect the USB Host interface of DG1000Z with the USB Device interface of DS1 using USB cable. Now, DS1 will enter "Remote" mode automatically.
3. Use DG1000Z to read the measured signal that is displayed currently on the screen of DS1 (two methods):
 - Press **Store** key at the front panel of DG1000Z to enter the store and recall interface. At this time, the model identifier of DS1 will be displayed in the "Directory Display Area". Press the menu key **File Type** at the store and recall interface of DG1000Z to select **Arb File**, and then set the **Browser** menu of DG1000Z as "Dir" and use the knob of DG1000Z to move the focus cursor onto the model identifier of DS1. Now, all channels and their on/off status of DS1 will be displayed in the "File/Folder Display Area". Set the **Browser** menu of DG1000Z as "File", and move the cursor onto the channel to be read, and then press **Read**. At this point, DS1 will enter the "Stop" mode automatically, and DG1000Z will read the arbitrary waveform data (namely the waveform data collected by DS1) automatically. After the read, the arbitrary waveform data is stored in the internal volatile memory of the current channel of DG1000Z and DG1000Z switches to arbitrary waveform (**Arb**) mode (if the current mode is not arbitrary waveform mode) automatically.
 - Press **Arb** key at the front panel of DG1000Z to enter arbitrary waveform mode, and press **Select Wform** → **Stored Wform** to enter the store and recall interface of arbitrary waveform (at this time, the backlight of the **Store** key at the front panel of DG1000Z turns on). Set the **Browser** menu of DG1000Z as "Dir" and use the knob of DG1000Z to move the focus cursor onto the model identifier of DS1. Now, all channels and their on/off states

of DS1 will be displayed in the "File/Folder Display Area". Set the **Browser** menu of DG1000Z as "File", and move the cursor onto the channel to be read, and then press **Read**. At this point, DS1 will enter the "Stop" mode automatically, and DG1000Z will read the arbitrary waveform data (namely the waveform data collected by DS1) automatically. After the read, the arbitrary waveform data is stored in the internal volatile memory of the current channel of DG1000Z.

4. Connect the output of the current channel of DG1000Z with the input of DS2. Turn on the channel output of DG1000Z and DG1000Z will output the arbitrary waveform collected by DS1. Configure DS2 to view the waveform collected by DS1.

Note: when the points of the waveform that DS1 has collected currently is less than 8k (8192), DG1000Z will complement the points to 8k (8192) by the way of linear interpolation if arbitrary waveform frequency output mode is currently selected and not change the points if arbitrary waveform sample rate output mode is currently selected.

Utility and System Settings

Press **Utility** at the front panel to open the operation interface as shown in the figure below. This interface displays the output configuration, coupling configuration and system parameters of the currently selected channel.

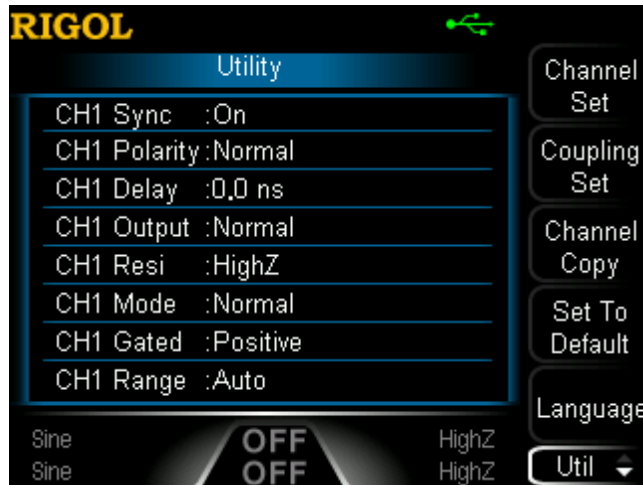

Figure 2-19 Utility Interface

Channel Set:	Set the output parameters of CH1 and CH2.
Coupling Set:	Set the channel coupling parameters.
Channel Copy:	Set the channel copy parameters.
Set To Default:	Restore the instrument to its default state.
Language:	Set the system language.
System Info:	View the model, serial number and software version number.
System:	Set parameters relative to the system.
I/O Config:	Set the remote interface parameters.
Print Set:	Set print parameters.
Test Cal:	View the calibration information and set parameters relative to the calibration.
PA Set:	Set the power amplifier parameters.

Channel Set

For DG1000Z, the function and setting method of CH1 are the same to those of CH2. This section takes CH1 for example to illustrate how to set the channel. To set the output parameters of CH2, please press **[CH1 | CH2]** to select CH2 and refer to this section to set the parameters.

Sync Set

DG1000Z could output the sync signals of basic waveforms (except Noise), arbitrary waveforms (except DC), Harmonics, Sweep signal, Burst signal and modulated signal from a single channel or from two channels at the same time. The instrument outputs the sync signal from the **[CH1/Sync/Ext Mod/Trig/FSK]** connector at the rear panel.

1. Sync On/Off

Enable or disable sync signal at the **[CH1/Sync/Ext Mod/Trig/FSK]** connector. Press **[Utility]** → **Channel Set** → **Sync Set** → **Switch** to select "On" or "Off" the output of the sync signal. The default is "On", namely transmitting the sync signal to the **[CH1/Sync/Ext Mod/Trig/FSK]** connector. When sync signal is disabled, the output level at the **[CH1/Sync/Ext Mod/Trig/FSK]** connector is logic low level.

2. Sync Polarity

Set the sync signal on the **[CH1/Sync/Ext Mod/Trig/FSK]** connector at the rear panel as normal or inverted. Press **[Utility]** → **Channel Set** → **Sync Set** → **Polarity** to select "Normal" or "Invert".

- Normal: outputs normal sync signal.
- Invert: outputs inverted sync signal.

3. Delay Time of Sync Signal Output

Set the delay time of the sync signal output of the **[CH1/Sync/Ext Mod/Trig/FSK]** connector at the rear panel relative to the signal output of the **[CH1]** connector at the front panel. Press **[Utility]** → **Channel Set** → **Sync Set** → **Delay**, input the desired value using the numeric keyboard and select the desired unit from the pop-up menu. The range is from 0.0ns to the currently selected period of the carrier waveform and the default is 0.0ns.

Note: when modulation, sweep or burst is enabled, the delay setting is invalid.

KEY POINTS:**Sync Signals of Various Waveforms:****1. Basic Waveform**

- 1) The frequency of the basic waveform is less than or equal to 100kHz or the sync delay is not 0:
The sync signal is a Square with 50% duty cycle and the same frequency as that of the basic waveform. When outputting the first waveform point, the sync signal is TTL high level.
- 2) The frequency of the basic waveform is greater than 100kHz:
 - Sine and Ramp: the sync signal is a Square with 50% duty cycle.
 - Square and Pulse: the sync signal is a Square with variable duty cycle which varies with the duty cycle of the output signal.

Take 0V voltage (or the DC Offset of the basic waveform) as the reference, the sync signal is TTL high level when the corresponding value of the output signal is greater than the reference. When the frequency of the basic waveform is less than or equal to 30MHz, the sync signal has the same frequency as the basic waveform. When the frequency of the basic waveform is greater than 30MHz, the frequency of the sync signal is (the basic waveform frequency $\div 2^n$). Wherein, n represents the frequency dividing coefficient and it is equal to 1 when the frequency of the basic waveform is greater than 30MHz and less than or equal to 60MHz.

- 3) Noise: there is no sync signal output.

2. Harmonics

For harmonics, the sync signal is a square with 50% duty cycle and the same frequency as that of the fundamental waveform. When outputting the first waveform point, the sync signal is TTL high level.

3. Arbitrary Waveform

For arbitrary waveform, the sync signal is a square with 50% duty cycle and the same frequency as that of the arbitrary waveform. When outputting the first waveform point, the sync signal is TTL high level.

4. Modulated Waveform (the sync delay is invalid)

- 1) When internal modulation source is selected:
the sync signal is a square with 50% duty cycle.
 - For AM, FM, PM and PWM, the frequency of the sync signal is the modulating frequency.
 - For ASK, FSK and PSK, the frequency of the sync signal is the modulating rate.
- 2) When external modulation source is selected:
The terminal is used to accept the external modulation signal and there is no sync signal output.

5. Sweep Waveform (the sync delay is invalid)

- 1) When internal or manual trigger source is selected:
 - If "Mark" is disabled:
The sync signal is a square with 50% duty cycle. The sync signal is TTL high level at the start of the sweep and changes to low level at the mid-point of the sweep. The frequency of the sync signal is the reciprocal of the sum of the specified sweep time, return time, start hold and end hold times.
 - If "Mark" is enabled:
For linear and log sweep, the sync signal is TTL high level at the start of the sweep and changes to low level at the mark frequency.

For step sweep (the sweep points determined by the start frequency, stop frequency and step number respectively are $f_1, f_2, \dots, f_n, f_{n+1} \dots$), if the mark frequency setting is one of the sweep points values, the sync signal is TTL high level at the start of the sweep and will change to low level at the mark frequency point. If the mark frequency setting is not any one of the sweep points values, the sync signal will change to low level at the sweep point which is closest to the mark frequency.
- 2) When external trigger source is selected:
The terminal is used to accept the external trigger signal and there is no sync signal output.

6. Burst Waveform(the sync delay is invalid)

- 1) When internal or manual trigger source is selected:
 - Infinite burst: the sync signal is the same as that of the basic waveform.
 - N cycle burst: the sync signal is TTL high level at the start of the burst and will change to TTL low level after the specified number of cycles finished. For the sync signal, the frequency is the **reciprocal** of the **Burst Period** and the duty cycle is **Carrier Period * Cycles / Burst Period**.
 - Gated burst: the terminal is used to accept the external modulation signal and there is no sync signal output.
- 2) When external trigger source is selected:
The terminal is used to accept the external trigger signal and there is no sync signal output.

Output Set

1. Output Polarity

Set the output signal on the [CH1] connector as normal or inverted. Waveform inversion is relative to the offset voltage. Press **Utility** → **Channel Set** → **Output Set** → **Output** to select "Normal" or "Invert". The default is "Normal". The waveform is normally outputted in "Normal" mode and is inverted before outputted in "Invert" mode. For example, the waveform of the first half period of the cycle is positive in "Normal" mode and negative in "Invert" mode, as shown in the figure below.

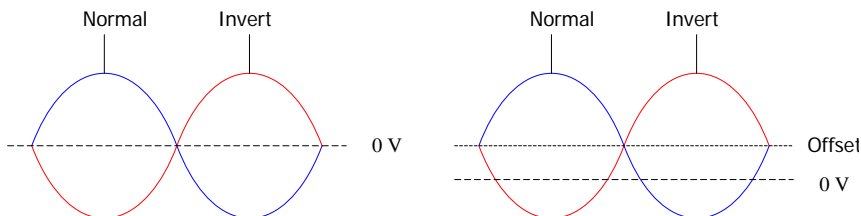

Note: the sync signal related to the waveform is not inverted when the waveform is inverted. To set the sync signal to invert, press **Utility** → **Channel Set** → **Sync Set** → **Polarity** and select "Invert".

2. Output Impedance

The output impedance setting influences output amplitude and DC offset. The instrument has a 50Ω fixed serial output impedance for the **[CH1]** connector at the front panel. If the actual load is different from the specified value, the voltage level displayed would not match the voltage level of the device under test. To ensure correct voltage level, the load impedance setting must match the actual load.

Press **Utility** → **Channel Set** → **Output Set** → **Imped** to select "HighZ" or "Load". The default is "HighZ". If "Load" is selected, use the numeric keyboard to set specific impedance value. The default is 50Ω and the available range is from 1Ω to $10k\Omega$. Impedance setting will be displayed on the screen.

The generator will adjust the output amplitude and offset voltage automatically once the impedance setting is changed. For example, the current amplitude is 5Vpp. At this point, change the output impedance from 50Ω to HighZ and the amplitude displayed on the screen will double to 10Vpp. If the output impedance is changed from HighZ to 50Ω , the amplitude will reduce to half of the previous value (2.5Vpp). Notice that only the displayed values change with the parameter and the real output from the generator does not change.

3. Output Mode

Set the output mode of the **[CH1]** connector as normal or gated. In gated mode, the output state of the **[CH1]** connector is controlled by the signal from the **[CH1/Sync/Ext Mod/Trig/FSK]** connector at the rear panel. When "Gated" is selected, press "Polarity" to select "Pos" or "Neg".

- Positive: the **[CH1]** connector outputs signal when the gated signal is high level.
- Negative: the **[CH1]** connector outputs signal when the gated signal is low level.

4. Range

Press **Utility** → **Channel Set** → **Output Set** → **Range** and select "Auto" or "Hold".

- Auto: the generator selects the best settings for the output amplifier and attenuator automatically.
- Hold: disable the automatic optimization, which can eliminate the discontinuation of the waveform caused by the relay switch when changing the amplitude but may affect the amplitude accuracy.

Waveform Summing

1. To Enable Waveform Summing Function

Press **Utility** → **Channel Set** → **Sum Wforms** → **Switch**, select “On” to enable the waveform summing function and sum a specified waveform on the current waveform or select “Off” to disable the waveform summing function.

Note: this function is valid only for the basic waveforms.

2. To Select Sum Source

Press **Utility** → **Channel Set** → **Sum Wforms** → **Sum Source** to select the desired waveform to be summed on the current waveform.

3. Sum Frequency

Set the frequency of waveform to be summed on the current waveform. Press **Utility** → **Channel Set** → **Sum Wforms** → **Sum Frequency** to input the desired value using the numeric keyboard and select the desired unit from the pop-up menu. The range is related to the currently selected waveform.

4. Sum Ratio

Set the ratio of the amplitude of the waveform to be summed on the current waveform relative to that of the current waveform. Press **Utility** → **Channel Set** → **Sum Wforms** → **Sum Ratio** to input the desired value using the numeric keyboard and select the unit % from the pop-up menu.

Coupling Set

DG1000Z supports frequency, amplitude and phase couplings. Users can set the frequency deviation (frequency ratio), amplitude deviation (amplitude ratio) or phase deviation (phase ratio) of the two channels. When coupling is enabled, CH1 and CH2 are mutual base source. When the frequency, amplitude or phase of one channel (as the base source) is changed, the corresponding parameter of the other channel will be changed automatically and always keeps the specified frequency deviation (ratio), amplitude deviation (ratio) or phase deviation (ratio) relative to the base channel.

Press **Utility** → **Coupling Set** to enter the channel coupling setting interface.

Frequency Coupling

1. Frequency Coupling Mode

Press **FCpl Mode** to select “FreqDev” or “Ratio” and then input the desired value using the numeric keyboard.

- FreqDev: the frequency deviation between CH1 and CH2. The parameter relations are as shown below:

$$F_{CH2} = F_{CH1} + F_{Dev}; F_{CH1} = F_{CH2} - F_{Dev}$$

- Ratio: the frequency ratio of CH1 and CH2. The parameter relations are as shown below:

$$F_{CH2} = F_{CH1} * F_{Ratio}; F_{CH1} = F_{CH2} / F_{Ratio}$$

Note: please set this parameter before enable the frequency coupling function. When frequency coupling is enabled, this menu is grayed out and disabled and you can not set the frequency deviation or frequency ratio.

2. To Enable Coupling Function

Press **Freq Cpl** to turn frequency coupling “On” or “Off”. The default is “Off”.

Amplitude Coupling

1. Amplitude Coupling Mode

Press **ACpl Mode** to select “AmplDev” or “Ratio” and then input the desired value using the numeric keyboard.

- AmplDev: the amplitude deviation between CH1 and CH2. The parameter relations are as shown below:

$$A_{CH2} = A_{CH1} + A_{Dev}; A_{CH1} = A_{CH2} - A_{Dev}$$

- Ratio: the amplitude ratio of CH1 and CH2. The parameter relations are as shown below:

$$A_{CH2} = A_{CH1} * A_{Ratio}; A_{CH1} = A_{CH2} / A_{Ratio}$$

Note: please set this parameter before enable the amplitude coupling function. When amplitude coupling is enabled, this menu is grayed out and disabled and you can not set the amplitude deviation or amplitude ratio.

2. To Enable Coupling Function

Press **Ampl Cpl** to turn amplitude coupling "On" or "Off". The default is "Off".

Phase Coupling

1. Phase Coupling Mode

Press **PCpl Mode** to select "PhaseDev" or "Ratio" and then input the desired value using the numeric keyboard.

- PhaseDev: the phase deviation between CH1 and CH2. The parameter relations are as shown below:

$$P_{CH2} = P_{CH1} + P_{Dev}; P_{CH1} = P_{CH2} - P_{Dev}$$

- Ratio: the phase ratio of CH1 and CH2. The parameter relations are as shown below:

$$P_{CH2} = P_{CH1} * P_{Ratio}; P_{CH1} = P_{CH2} / P_{Ratio}$$

Note: please set this parameter before enable the phase coupling function. When phase coupling is enabled, this menu is grayed out and disabled and you can not set the phase deviation or phase ratio.

2. To Enable Coupling Function

Press **PhaseCpl** to turn phase coupling "On" or "Off". The default is "Off".

When the corresponding coupling functions are enabled, green "*" marks are separately displayed on the left of the frequency, amplitude and phase of the two channels as shown in the figure below, indicating that the generator is in frequency, phase and amplitude couplings at the same time. For example, when the frequency, amplitude and phase deviation are set to "100Hz", "1Vpp" and "10°" respectively, change the frequency, amplitude and phase of CH1 to 200Hz, 2Vpp and 20° respectively and the parameters of CH2 will be changed to 300Hz, 3Vpp and 30° automatically; use **CH1|CH2** to switch to CH2, change the frequency, amplitude and phase of CH2 to 200Hz, 2Vpp and 20° respectively and the parameters of CH1 will be changed to 100Hz, 1Vpp and 10° automatically.

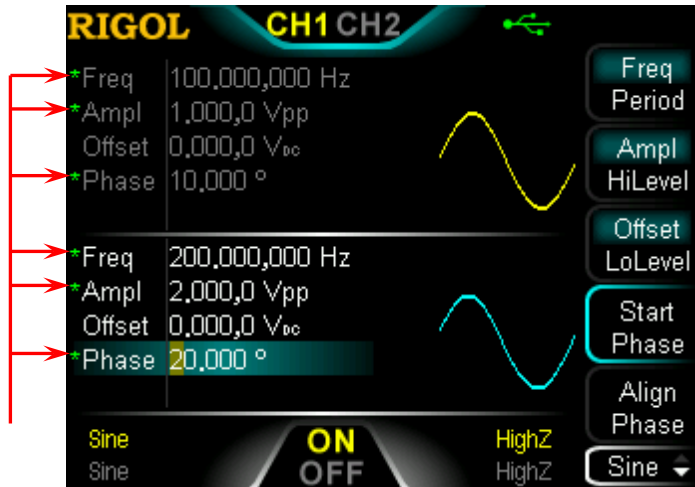

Figure 2-20 Channel Coupling

KEY POINTS:

- Channel coupling is only available when both the waveforms of the two channels are basic waveforms including Sine, Square, Ramp and Arbitrary waveform (except DC).
- If the sum (or product) of the frequency, amplitude or phase of CH1 and the deviation (or ratio) set exceeds the upper limit of frequency, amplitude or phase of CH2 or the value of the frequency, amplitude or phase of CH2 minus (or is divided by) the deviation (or ratio) set is below the lower limit of frequency, amplitude or phase of CH1, the generator will adjust the frequency, phase or amplitude of the later channel to avoid parameter overrange.
- When the phase of the one channel is changed, the phase (phase displayed on the interface) of the other channel will be changed accordingly. At this point, aligning phase between the two channels can be realized without executing the **Align Phase** operation.
- Channel coupling and channel copy are mutually exclusive. When channel coupling is enabled, the menu **Channel Copy** is grayed out and disabled.

Track

Press **Track** to select the track mode as “On”, “Invert” or “Off”.

- On: enable the track function. The instrument copies the various parameters and states (except the channel output state) of CH1 to CH2 automatically. When the parameters or states of CH1 are changed, the corresponding parameters or states of CH2 (except the channel output state) will be adjusted to the same values or states automatically. At this point, the dual channels can output the same signal (if currently enabled).
- Invert: the track function is enabled. The instrument copies the various parameters and states (except the channel output state) of CH1 to CH2 automatically. When the parameters or states of CH1 are changed, the corresponding parameters or states of CH2 (except the channel output state) will be adjusted to the same value automatically. At this point, CH2 outputs the inverted signal of the output signal of CH1 (if currently enabled).
- Off: disable the track function. This is the default state.

Note: when track function is enabled, coupling function and channel copy function are disabled, the user interface is switched to single channel view mode and the current channel is CH1.

Channel Copy

DG1000Z supports states and waveform copy function between its two channels, namely copies all parameters and states (except the channel output state) and arbitrary waveform data of one channel to the other one.

Press **Utility** → **Channel Copy** to enter the channel copy setting interface.

Press **CH1=>CH2** to copy all parameters and states (except the channel output state) and arbitrary waveform data of CH1 to CH2.

Press **CH2=>CH1** to copy all parameters and states (except the channel output state) and arbitrary waveform data of CH2 to CH1.

Note: channel coupling or track function and channel copy function are mutually exclusive. When channel coupling or track function is enabled, the menu **Channel Copy** is grayed out and disabled.

Restore Default

Restore the instrument to its default state.

Press **Utility** → **Set To Default** → **OK**, the backlight of **Utility** turns off and switch the instrument to Sine display mode. The default values are shown in the table below. Note that the items marked with "*" are set at the factory and are related to the set of the users and will not be affected by the **Set To Default** operation.

Table 2-4 Factory Default Values

Parameters	Defaults
Channel Parameters	
Current Carrier Waveform	Sine
Output Impedance	HighZ
Output Load	50 Ω
Sync Output	On
Sync Polarity	Pos
Sync Delay	0s
Channel Output	Normal
Output Mode	Normal
Gated Polarity	Pos
Range	Auto
Waveform Sum Switch	Off
Sum Source	Sine
Sum Frequency	1kHz
Sum Ratio	100%
Basic Waveform	
Frequency	1kHz
Amplitude	5Vpp
Amplitude Unit	Vpp
Offset	0V _{DC}
Start Phase	0°
Square Duty Cycle	50%
Ramp Waveform Symmetry	50%
Pulse Duty Cycle	50%
Pulse Width	500μs
Pulse Leading Edge	20ns
Pulse Trailing Edge	20ns
Harmonic Type	Even
Harmonic Order	2
Harmonic Phase (7)	0°
Harmonic Serial Number	2
Harmonic Amplitude (7)	1.2647Vpp

Harmonic State	Off
User-defined	X0000000
Arb Waveform	
Sample Rate	20MSa/s
DC Offset	0V _{DC}
Arb Waveform Mode	Frequency
Built-in Arbitrary Waveform	Sinc
Insret Waveform	
Insert position	1
Insert Way	Insert
Cycles	1
Points	8
High Level	2.5V
Low Level	-2.5V
Edit Points	
Points	1
Voltage	-2.5V
Edit Block	
X1	1
Y1	-2.5V
X2	8
Y2	-2.5V
Modulation	
Modulation Type	AM
AM Modulation	
Modulation Source	Int
Modulating Waveform Shape	Sine
Modulation Frequency	100Hz
Modulation Depth	100%
Carrier Waveform Suppression	Off
FM Modulation	
Modulation Source	Int
Modulating Waveform Shape	Sine
Modulation Frequency	100Hz
Frequency Deviation	1kHz
PM Modulation	
Modulation Source	Int
Modulating Waveform Shape	Sine
Modulation Frequency	100Hz
Phase Deviation	90°
ASK Modulation	
Modulation Source	Int

ASK Rate	100Hz
Modulation Amplitude	2Vpp
ASK Polarity	Pos
FSK Modulation	
Modulation Source	Int
FSK Rate	100Hz
Hop Frequency	10kHz
FSK Polarity	Pos
PSK Modulation	
Modulation Source	Int
PSK Rate	100Hz
PSK Phase	180°
PSK Polarity	Pos
PWM Modulation	
Modulation Source	Int
Modulating Waveform Shape	Sine
Modulation Frequency	100Hz
Width Deviation	200μs
Duty Cycle Deviation	20%
Sweep	
Sweep Type	Linear
Sweep Time	1s
Return Time	0s
Start Frequency	100Hz
Stop Frequency	1kHz
Center Frequency	550Hz
Frequency Span	900Hz
Start Hold	0s
Stop Hold	0s
Mark Frequency State	Off
Mark Frequency	550Hz
Trigger Source	Int
Trigger Output	Off
SlopeIn	Leading
Step Number	2
Burst	
Burst Mode	N Cycle
Cycle Number	1
Burst Period	10ms
Gated Polarity	Pos
Trigger Source	Int
Trigger Output	Off

Trigger Input	Leading
Delay	0ns
Interface Focus Items	
Frequency/Period	Freq
Amplitude/High Level	Ampl
Offset/Low Level	Offset
Pulse Width/Duty Cycle	Duty
Start/Center	Start
Stop/Span	Stop
Frequency Coupling Deviation/Ratio	Ratio
Amplitude Coupling Deviation/Ratio	Ratio
Phase Coupling Deviation/Ratio	Ratio
Default Channel	CH1
Counter	
Measurement Parameter	Frequency
Gate Time	1ms
Statistic Function	Off
Display Mode	Digital
Trigger Sensitivity	25%
Trigger Level	0V
Coupling Mode	AC
High-frequency Suppression	Off
System Parameter	
Coupling Set	
Frequency Coupling	Off
Frequency Deviation	0uHz
Frequency Ratio	1
Amplitude Coupling	Off
Amplitude Deviation	0Vpp
Amplitude Ratio	1
Phase Coupling	Off
Phase Deviation	0°
Phase Ratio	1
Track	Off
Print Set	
Print Switch	Off
Print Destination	Usb Disk
Print Format	Bmp
Print Copies	0
Print Palette	Gray
Invert	On

UI Customization	
Set Coordinate*	(0,0)
System Set	
Power On Setting	Default
Clock Source	Int
Decimal Point	Dot
Thousand Separator	Comma
Beeper	On
Screen Saver	On
Brightness*	50%
Contrast*	25%
Display Mode*	Dual Channels Parameters
Language*	Factory Delivery Setting
I/O Configuration	
USB Device Type	Computer
GPIB*	2
DHCP*	On (default setting in LAN)
Auto IP*	On (default setting in LAN)
Manual IP*	Off (default setting in LAN)

To Set System Language

At present, DG1000Z supports various system languages, including Chinese/English menu, help information, prompt messages, interface display and Chinese/English input method.

Press **Utility** → **Language** to select the desired language. This setting is stored in non-volatile memory and will not be influenced by the **Set To Default** operation.

System Information

Press **Utility** → **System Info** and the model, serial number, software version numbers of the current instrument are displayed in the system information interface.

System Set

Power On Set

Set the configuration to be used when the instrument is powered on the next time to “Default” or “Last”. The default setting is “Default”.

- Last: includes all system parameters and states, except channel output state and clock source.
- Default: denotes the factory defaults except certain parameters (such as Language).

Press **Utility** → **System** → **Power On** to select the desired configuration type. This setting is stored in non-volatile memory and will not be influenced by the **Set To Default** operation.

Clock Source

DG1000Z provides an internal 10MHz clock source and accepts external clock source from the **[10MHz In/Out]** connector at the rear panel. It can also output clock source from the **[10MHz In/Out]** connector for other devices.

Press **Utility** → **System** → **Clk Src** to select “Int” or “Ext”. The default is “Int”. If “Ext” is selected, the instrument will detect whether a valid external clock signal is input from the **[10MHz Out/In]** connector at the rear panel. If no valid clock source is detected, the prompt message “Not detect a valid external clock!” would be displayed and the clock source would be switched to “Int”.

You can synchronize two or more instruments by setting the clock source. When two instruments are synchronized, the “Align Phase” function can not be used. “Align phase” is only applicable to be used to adjust the phase relation between two output channels of the same instrument and can not be used to change the phase relation between the output channels of two instruments. Of course, you can change the phase relation between two instruments by changing the “Start Phase” of each channel.

Sync methods for two or more instruments:

- Synchronization between two instruments:
Connect the **[10MHz In/Out]** connector of Generator A (“Internal” clock) to the **[10MHz In/Out]** connector of Generator B (“External” clock) and set the output frequencies of A and B as a same value to realize synchronization between two instruments.
- Synchronization among multiple instruments:
Divide the 10MHz clock source of a Generator (“Internal” clock) into multiple channels, and then connect them to the **[10MHz In/Out]** connectors of other

generators (“External” clock) respectively, and finally set the output frequencies of all the generators as a same value to realize synchronization among multiple instruments.

Number Format

You can set the display format of the decimal point and thousands separator in number parameters. This setting is stored in non-volatile memory. Press **Utility** → **System** → **Number Format** to enter the number format setting interface.

- Decimal Point: could be set as dot “.” or comma “,”. The default is dot “.”.
- Thousands separator: could be set as “,”, “Space” or “None” when decimal point is set as “.”; could be set as “.”, “Space” or “None” when decimal point is set as “,”.

Number display format has 6 combinations as shown in the figure below.

Freq 1.000,000,000 kHz Dot + Comma

Freq 1.000 000 000 kHz Dot + Space

Freq 1.000000000 kHz Dot + None

Freq 1,000.000.000 kHz Comma + Dot

Freq 1,000 000 000 kHz Comma + Space

Freq 1,000000000 kHz Comma + None

Note: decimal point and thousands separator can not be set as dot or comma at the same time.

Beeper

When the beeper in DG1000Z is enabled, a beep is generated when an error occurs during front panel or remote operation.

Press **Utility** → **System** → **Beep** to select “On” or “Off” and the default is “On”.

Screen Saver

Enable or disable screen saver mode. Press **Utility** → **System** → **Scrn Svr** to select “On” or “Off” and the default is “On”.

Display Set

Press **Utility** → **System** → **Display** to enter the display setting interface. You can set the brightness, contrast and display mode. Besides, you can also customize the start-up interface.

1. Brightness

Press **Brightness** and use the numeric keyboard or direction keys and knob to change the brightness. The range is from 1% to 100% and the default is 50%. This setting is stored in non-volatile memory and will not be influenced by the **Set To Default** operation.

2. Contrast

Press **Contrast** and use the numeric keyboard or direction keys and knob to change the **Contrast**. The range is from 1% to 100% and the default is 25%. This setting is stored in non-volatile memory and will not be influenced by the **Set To Default** operation.

3. Display Mode

Press **DispMode** to select the display mode as “Dual Channels Parameters”, “Dual Channels Graph” or “Single Channel View”.

- Dual Para: the various parameters and waveforms of the dual channels are displayed at the same time in number and graph formats.
- Dual Graph: the current waveforms of the dual channels are displayed at the same time in graph format.
- Single View: the various parameters and waveform of the currently selected channel are displayed in number and graph formats.

4. Customize GUI

DG1000Z allows users to define the start-up interface. You can store the content to be displayed to USB Disk in the format of BMP. Insert an USB Disk to the USB HOST interface at the front panel of the generator and press **Custom GUI** to enter the user-defined start-up setting interface. Select the desired file in BMP format and set the coordinate of the file in the interface.

- Open the File: Press **Open File** to enter the store and recall interface and select the desired file in BMP format.

Note: the internal memory can not store files in BMP format. Please store the content to be displayed to USB Disk in the format of BMP and the size of the image can not exceed 320*240.

- **Set Coordinate:** set the coordinate of the image selected in the interface. Press **Coordinate** and set the coordinate values using the numeric keyboard or direction keys and knob.
Note: the coordinate settings are the coordinate of the upper left corner of the image selected. Suppose the pixel of the image selected is X*Y, the available ranges of the coordinates are from (000,000) to (320-X,240-Y).
- **Preview:** after selecting the desired bitmap file and the coordinates are set, press **Preview** to preview the effect of the user-defined start-up interface. Press any key to quit the preview.
- **Save:** save the defined start-up interface and this interface will be displayed at the next start-up.
- **Boot UI:** switch the current start-up interface to default or user-defined.

I/O Configuration

DG1000Z is configured with USB, LAN and GPIB (option) interfaces. Users can set the GPIB address or LAN interface parameters (the USB parameters don't need to be configured).

Press **Utility** → **I/O Config** to open the I/O setting menu, you can set the GPIB address or LAN interface parameters or select the type of the device connected to USB interface. The interface selection is stored in the non-volatile memory.

To Set GPIB Address

Each device connected to GPIB interface must have a unique address.

Press **Utility** → **I/O Config** → **GPIB** and set the GPIB address to any value between 0 and 30. The default is "2". The selected address is stored in non-volatile memory.

To Set LAN Parameters

Press **Utility** → **I/O Config** → **LAN** to open the LAN parameters configuration interface as shown in the figure below. You can view the network status and configure the network parameters. At this point, press  to view the other network configuration parameters.

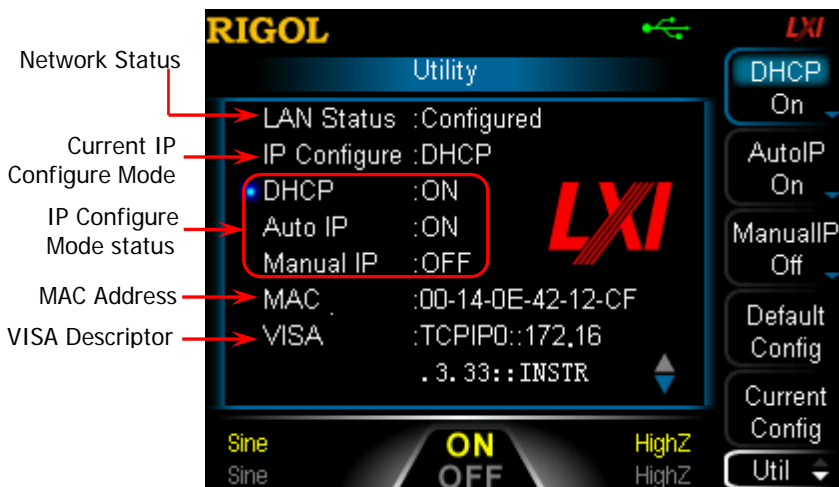

Figure 2-21 LAN Setting Interface

Network Status

Different prompt messages will be provided by the generator based on the current network status.

- Connected: indicates LAN connection is successful.
- Disconnect: indicates no LAN connection or LAN connection is unsuccessful.

MAC Address

MAC (Media Access Control) address, also called hardware address, is used for defining the position of the network device. For a generator, the MAC address is always unique. It is always used to identify the instrument while assigning IP address for instrument. MAC address (48 bits, namely 6 bytes) is usually expressed in hexadecimal format, such as 00-14-0E-42-12-CF.

VISA Descriptor

VISA (Virtual Instrument Software Architecture) is an advanced application programming interface developed by NI (National Instrument) for communications with various instrument buses. It uses the same method to communicate with instruments regardless of the types of the instrument interfaces (GPIB, USB, LAN/Ethernet or RS232). The GPIB, USB, LAN/Ethernet or RS232 instrument which wants to communicate with VISA is called "resource".

VISA descriptor is the resource name and describes the accurate name and location of the VISA resource. If LAN interface is currently used for communication with the instrument, the VISA descriptor is TCPIP0::172.16.3.33::INSTR.

IP Configuration Mode

IP configuration mode could be DHCP, AutoIP or ManualIP. If the network is disconnected currently, there will be nothing to be displayed behind "IP Configure:". In different IP configuration modes, the configuration ways of network parameters (such as IP address) are different.

1. DHCP

- In DHCP mode, DHCP server in the current network assigns LAN parameters, e.g. IP address, for the generator.
- Press **DHCP** to select "On" or "Off" to turn DHCP mode on or off. The default is "On".

2. AutoIP

- In AutoIP mode, the generator acquires IP address within 169.254.0.1 and 169.254.255.254 and subnet mask 255.255.0.0 automatically according to the current network configuration.
- Press **AutoIP** to select "On" or "Off" to turn AutoIP mode on or off. The default is "On". When DHCP and AutoIP modes are turned on at the same time, the instrument will first use DHCP mode. Therefore, to enable this mode, set **DHCP** as "Off".

3. ManualIP

- In ManualIP mode, the LAN parameters of the generator, e.g. IP address, are defined by users.
- Press **ManualIP** to select "On" or "Off" to turn ManualIP mode on or off. The default is "Off". If all the three IP configuration modes are "On", the priority of parameters configuration from high to low is "DHCP", "AutoIP" and "ManualIP". Therefore, to enable this mode, set **DHCP** and **AutoIP** as "Off".
- The IP address format is nnn.nnn.nnn.nnn. The first nnn ranges from 1 to 223 (except 127) and the other three nnn range from 0 to 255. It is recommended that users acquire an available IP address from their network administrator.
- Press **IP Address** and use the direction keys and numeric keyboard or knob to enter your desired IP address. The setting is stored in non-volatile memory and will be loaded automatically when the generator is powered on the next time if DHCP and AutoIP are set as "Off".

TIPS:

- If all the three IP configuration modes are "On", the priority of parameters configuration from high to low is "DHCP", "AutoIP" and "ManualIP".
- The three IP configuration modes cannot be set as "Off" at the same time.

To Set Subnet Mask

In ManualIP mode, the subnet mask could be manually set.

- The format of subnet mask is nnn.nnn.nnn.nnn, wherein nnn ranges from 0 to 255. It is recommended that users acquire an available subnet mask from their network administrator.
- Press **SubMask** and use the direction keys and numeric keyboard or knob to enter your desired subnet mask. The setting is stored in non-volatile memory and will be automatically loaded when the generator is powered on the next time if DHCP and AutoIP are set as "Off".

To Set Default Gateway

In ManualIP mode, the default gateway could be manually set.

- The format of default gateway is nnn.nnn.nnn.nnn, wherein the first nnn ranges from 1 to 223 (except 127) and the other three nnn range from 0 to 255. It is recommended that users acquire an available default gateway from their network administrator.
- Press **Default Gateway** and use the direction keys and numeric keyboard or knob to enter your desired gateway address. The setting is stored in non-volatile memory and will be automatically loaded when the generator is powered on the next time if **DHCP** and **AutoIP** are set as "Off".

To Set DNS Service

In ManualIP mode, the DNS could be manually set.

- The DNS format is nnn.nnn.nnn.nnn, wherein the first nnn ranges from 1 to 223 (except 127) and the other three nnn range from 0 to 255. It is recommended that users acquire an available DNS address from their network administrator.
- Press **DNS Service** and use the direction keys and numeric keyboard or knob to enter your desired DNS address. The setting is stored in non-volatile memory and will be automatically loaded when the generator is powered on the next time if **DHCP** and **AutoIP** are set as "Off".

Default Configuration

Press **Default Config** and the prompt message "Restore network settings to preset values of LXI?" is displayed. Press **OK** to restore the network parameters to their default values. By default, DHCP and AutoIP are enabled and ManualIP is disabled.

Current Configuration



Press **Current Config** to examine the MAC address of the current instrument, the current LAN parameters and LAN status information.

OK

Press **OK** to enable the current setting of LAN parameters.

Print Set

Users could store the contents displayed on the screen into external USB storage device in picture format.

1. Please connect a USB storage device first. When connected successfully, the icon  will be displayed in the status bar on the screen and the corresponding prompt message will be displayed on the screen.
2. Press **Utility** → **Print Set** → **Print** → "On" to enable the print function.
3. Switch the content displayed on the screen to the interface to be printed. Press the key  at the front panel twice continuously and the contents displayed on the screen will be stored into the USB storage device in picture format according to the preset configuration. During the store process, the print progress bar is displayed on the screen.

Test/Calibration

Press **Utility** → **Test Cal** to view calibration state and calibration time.

Besides, press **Utility** → **Test Cal** → **Manual Cal** to input correct calibration password and press **Ok** to enter the manual calibration interface. At this time, you can calibrate the instrument manually. A default password is set when factory delivery and please contact **RIGOL** if you want to acquire this password. If you have already known the password, you could modify the password (press **Password Modify** and modify the password according to the interface prompts).

NOTE:

The recommended calibration interval is 1 year. The instrument has been calibrated before leaving factory. Calibration by users themselves is not recommended and if calibration is required, please contact **RIGOL**.

To Use External Power Amplifier (Option)

DG1000Z supports the connection with the Power Amplifier (PA). You can configure the parameters of the Power Amplifier (PA) and DG1000Z will amplify the signal before output. To use external power amplifier, please install the PA1011 option.

PA1011 is one of the options provided for **RIGOL** DG Series Function/Arbitrary Waveform Generators, with up to 1 MHz full power bandwidth and higher than 80 V/ μ s slew rate. It can be connected with all DG series products to quickly build test platform and can also be used as an independent power amplifier to be used with other signal generators.

Main Features of PA1011:

- Flexible and easy communication with **RIGOL** DG Series Function/Arbitrary Waveform Generators or PC software through the USB interface.
- You can set the gain (x1 or x10), output polarity (Normal or Invert), output offset and output switch of the power amplifier flexibly in connection with its software.
- Up to 50k Ω input impedance.
- The integrated output protection circuit (over-current protection and internal temperature abnormal protection) ensures the instrument is working stably, reliably and safely.
- Compact size, easy to carry and use.

Front Panel:

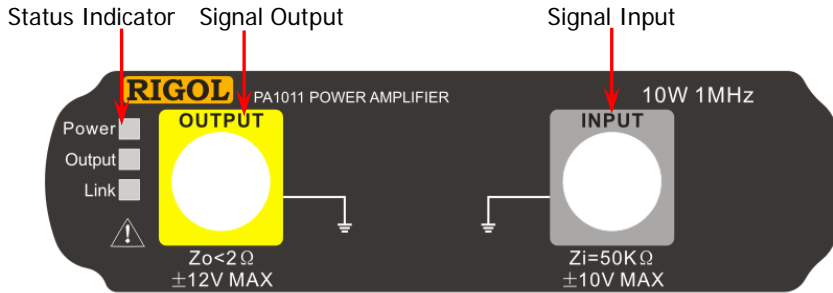

Status Indicator

Power: red light on, indicating successful power connection.
 Output: green light on, indicating that PA output is turned on.
 Link: yellow light on, indicating successful USB connection.



CAUTION

The input impedance of the instrument Z_i is $50k\Omega$, and the range of voltage is from $-10V$ to $+10V$ or from $-1.25V$ to $+1.25V$ separately while the voltage gain is set to X1 or X10. Inputs that exceed these ranges may cause damages to the instrument or other hazards.



CAUTION

The output impedance of the instrument Z_o is less than 2Ω , and the range of output voltage is from $-12V$ to $+12V$. Although the amplifier actually enables to output voltages up to $\pm 12.5V$, the total wave harmonic distortion may increase.

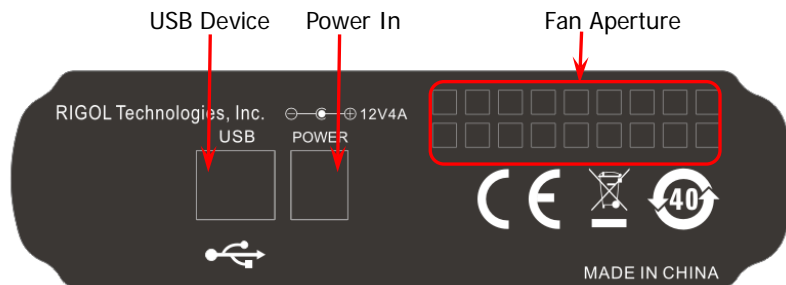
Rear Panel:**CAUTION**

Do not use any other adapters to supply power for PA1011, or else it may cause degradation or perpetual damage.

**CAUTION**

Please make sure the vents at both sides and the fan aperture at the rear panel are visible in operation for normal working.

PA1011 Accessories:

Name	Qty.	Description
Power Cord	1	Connect the AC into the power adaptor.
AC Adaptor	1	Output 12V, 4A signal.
USB Cable	1	Connect PA1011 with DG1000Z.
BNC Cable	1	Connect PA1011 with DG1000Z.
CD-ROM	1	Provide the PC software installation program of PA1011.

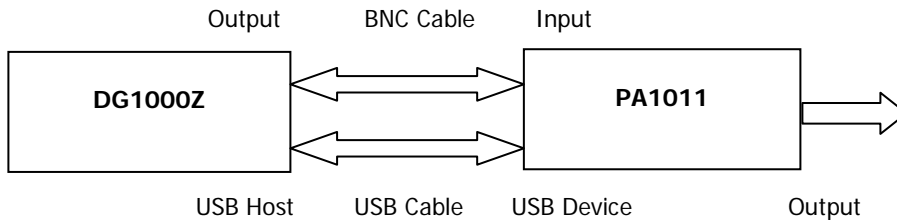
Connect DG1000Z with PA1011:

When the connection between DG1000Z and PA1011 as shown in the figure above succeeds, press **Utility** → **PA Set** at the front panel of DG1000Z to enter the PA parameters setting interface.

1. Switch

Turn "On" or "Off" the external power amplifier. If "On" is selected, the PA amplifies and then outputs the input signal (namely the output signal of the signal generator); if "Off" is selected, the PA has no output.

2. Gain

Select "X1" or "X10" as the amplifier gain of the signal output from the PA. "X1" means output without gain and "X10" means to amplify the signal 10 times and then output.

3. Output

Select "Normal" or "Invert" output mode for the signal output from the PA. Pay attention to distinguish it with "**Output Polarity**" of DG1000Z.

4. Offset

Turn "On" or "Off" the output deviation for the output from the PA. When "On" is selected, use the numeric keyboard or direction keys and knob to set deviation value. The available range is from -12V to 12V and the default value is 0V.

5. Store

Store the current working state of the PA in its internal memory. When the PA is turned on the next time, it will automatically recall the stored working state.

TIP:

For specifications of PA1011, please refer to "**Appendix B: Specifications of Power Amplifier**".

Chapter 3 Remote Control

DG1000Z series function/arbitrary waveform generator can be controlled remotely via the following two modes.

User-defined programming

Users can program and control the instrument by using the SCPI (Standard Commands for Programmable Instruments) commands. For more information about the commands and programming, refer to the Programming Guide.

Use PC software provided by RIGOL or other manufacturers

Users can use the PC software **Ultra Sigma** of **RIGOL, Measurement & Automation Explorer** of **NI** (National Instruments Corporation) or **Agilent IO Libraries Suite** of **Agilent** (Agilent Technologies, Inc.) to send commands to control the instrument remotely.

This generator can communicate with PC through USB, LAN and GPIB (with the USB to GPIB interface converter provided by **RIGOL**) instrument buses. This chapter will give a detailed introduction of how to use **Ultra Sigma** to control the generator (take DG1062Z as an example) remotely through various interfaces. To acquire the **Ultra Sigma** software, please contact **RIGOL** salesmen or technical support.

The contents of this chapter are as follows:

- Remote Control via USB
- Remote Control via LAN
- Remote Control via GPIB (Option)

Remote Control via USB

1. Connect the device

Connect the USB DEVICE interface at the rear panel of DG1062Z with your PC using a USB cable.

2. Install the USB driver

This generator is a USB-TMC device. Assuming that your PC has already been installed with **Ultra Sigma**, after you connect the generator to the PC and turn both on for the first time (the generator is automatically configured to USB interface), the New Hardware Wizard as shown in the figure below is displayed on the PC. Please install the "USB Test and Measurement Device (IVI)" driver following the directions in the wizard. The steps are as follows.

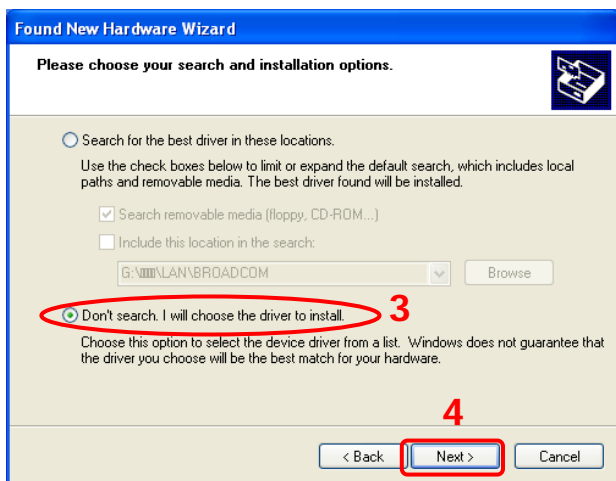
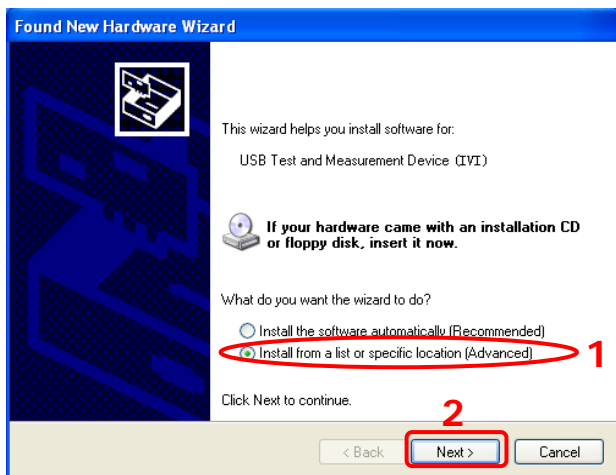

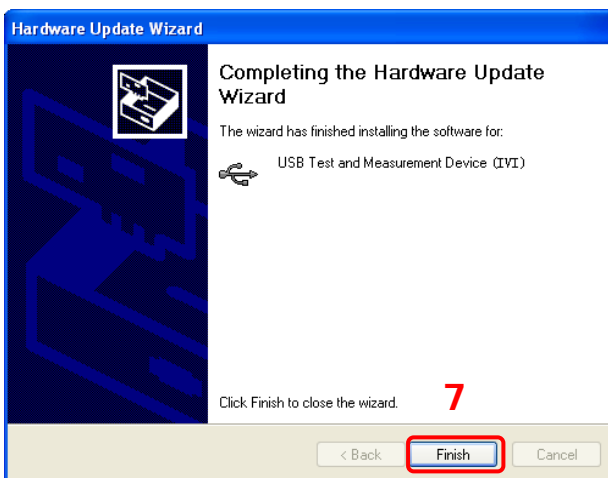
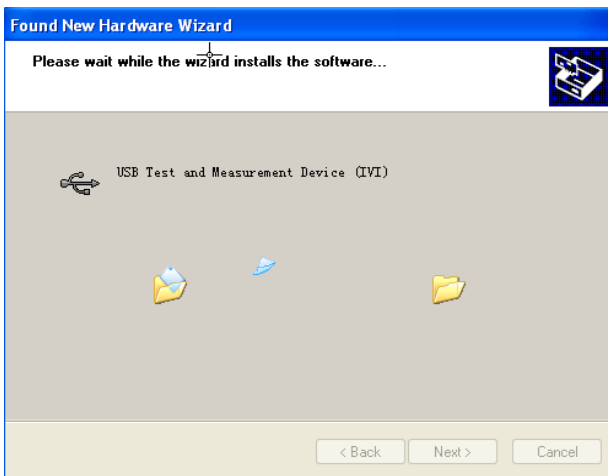
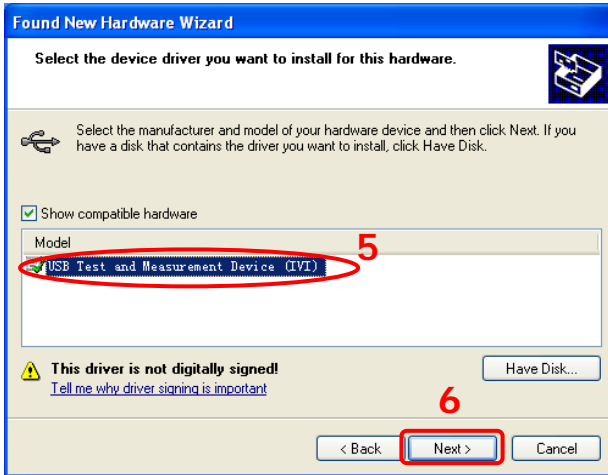

3. Search device resource

Start up the **Ultra Sigma** and the software will automatically search for the generator resources currently connected to the PC. You can also click **USB-TMC** to search the resources. During the search, the status bar of the software is as shown in the figure below.



4. View the device resource

The resources found will appear under the "RIGOL Online Resource" directory and the model number and USB interface information of the instrument will also be displayed as shown in the figure below.

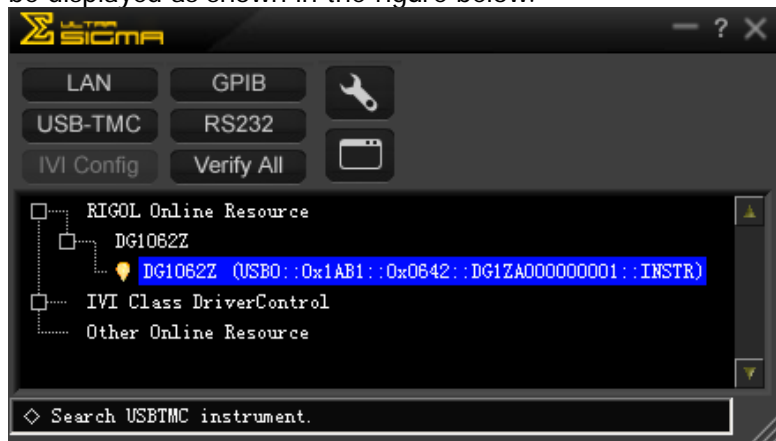

5. Communication test

Right click the resource name "DG1062Z (USB0::0x1AB1::0x0642::DG1ZA000000001::INSTR)" to select "SCPI Panel Control" to turn on the remote command control panel (as shown in the figure below) through which you can send commands and read data.

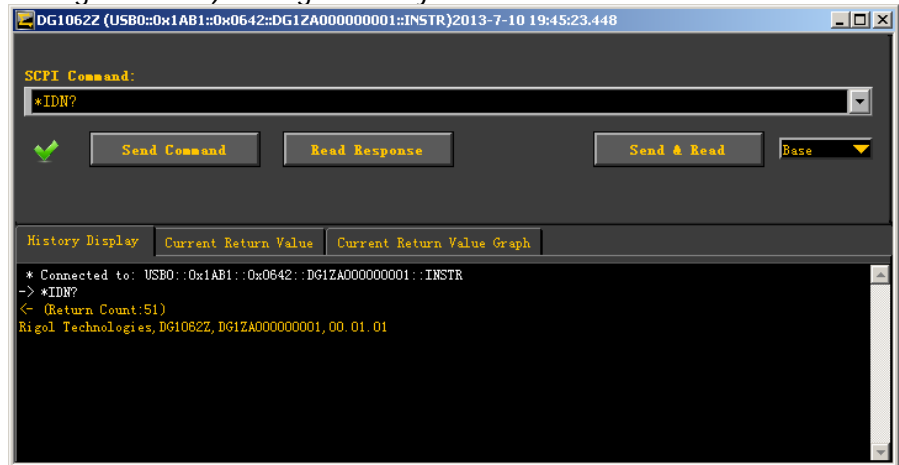

Remote Control via LAN

1. Connect the device

Connect the generator to your PC or the LAN of your PC using a network cable.

2. Configure network parameters

1) DHCP mode:

If the network supports DHCP, the DHCP server in the network assigns network parameters (IP Address, Subnet Mask, Gateway and DNS) for the generator automatically.

2) Auto IP mode:

When the network doesn't support DHCP, the DHCP mode of the generator is disabled or the generator is connected to the PC directly, the generator selects Auto IP mode and acquires the IP address from 169.254.0.1 to 169.254.255.254 and subnet mask 255.255.0.0 automatically.

3) Manual IP mode:

Enable the Manual IP mode and disable the DHCP mode as well as the Auto IP mode to set the network parameters manually.

If the generator is connected to the PC directly, set the IP Addresses, Subnet Masks and Gateways for both of the PC and the generator. The Subnet Masks and Gateways of the generator and PC must be the same and the IP Addresses of them must be within the same network segment (for details, refer to the TCP/IP protocol). An example is shown in the table below.

Network Parameters	PC	Generator
IP Address	192.16.3.3	192.16.3.8
Subnet Mask	255.255.255.0	255.255.255.0
Default Gateway	192.16.3.1	192.16.3.1

If your generator is connected to the LAN of your PC, please acquire valid network parameters (such as IP Address) and configure the network parameters of the generator according to the description in "**To Set LAN Parameters**".

3. Search device resource

Start up the **Ultra Sigma** and click **LAN**. The window as shown in figure (a) is displayed. Click **Search** and the software searches for the instrument resources currently connected to the LAN and the resources found are displayed at the right of the window as shown in figure (b). Click **OK** to add it.



(a)

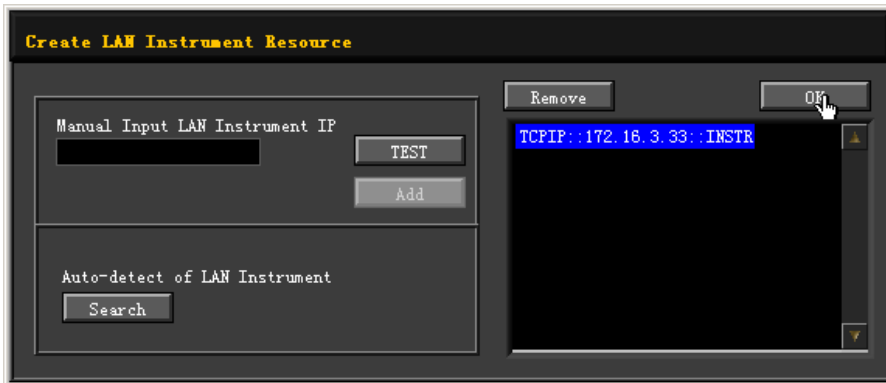

(b)

4. View device resource

The resources found will appear under the “RIGOL Online Resource” directory as shown in the figure below.



5. Communication test

Right click the resource name “DG1062Z (TCPIP::172.16.3.33::INSTR)” to select “SCPI Panel Control” to turn on the remote command control panel (as shown in the figure below) through which you can send commands and read data.



6. Load LXI webpage

As this generator conforms to LXI Core Device 2011 standards, you can load LXI webpage through **Ultra Sigma** (right-click the resource name and select LXI-Web) or directly inputting the IP address in the browser. Various important information about the instrument (including the model, manufacturer, serial number, description, MAC address and IP address etc.) will be displayed on the webpage.

Remote Control via GPIB (Option)

1. Connect the device

Connect the generator to your computer using a USB to GPIB interface converter (Option).

Note: please make sure that a GPIB card has been installed to your PC. Connet the USB terminal of the USB to GPIB interface converter to the USB Host interface at the front panel of the generator and the GPIB terminal of it to the GPIB card terminal of the PC.

2. Install the driver of GPIB card

Install the driver of the GPIB card which has been connected to the PC correctly.

3. Set the GPIB address

Press **Utility** → **I/O Config** → **GPIB** to set the GPIB address of the generator.

4. Search device resource

Start up the **Ultra Sigma** and click **GPIB** to open the panel as shown in the figure below. Click "Search" and the software will search the GPIB instrument resources connected to the PC. The device resources found will be displayed on the right side of the panel.



If resources cannot be found automatically:

- Select the GPIB card address of the PC from the comboBox of "GPIB::" and select the GPIB address set in the generator from the comboBox of "::INSTR".
- Click "Test" to check whether the GPIB communication works normally; if not, please follow the corresponding prompt messages to solve the problem.

5. View device resource

Click **OK** to return back to the main interface of Ultra Sigma. The resources found will appear under the “RIGOL Online Resource” directory as shown in the figure below.



6. Communication Test

Right-click the resource name “DG1062Z (GPIB0::16::INSTR)” to select “SCPI Panel Control” to turn on the remote command control panel as shown in the figure below through which you can send commands and read data.

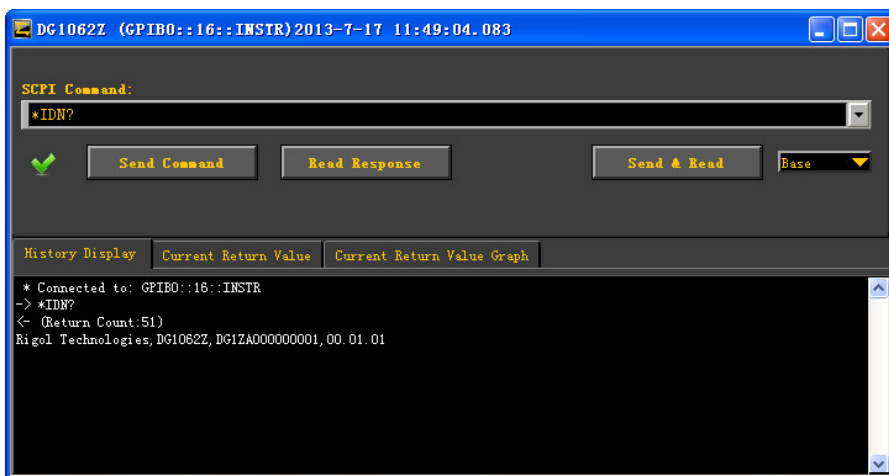

Chapter 4 Troubleshooting

This chapter lists the commonly encountered failures of DG1000Z and their solutions. When you encounter those problems, please solve them following the corresponding steps. If the problem remains still, please contact **RIGOL** and provide the device information of your instrument (**Utility** → **System Info**).

1. The screen of the generator is still dark (no display) after pressing the power key:

- 1) Check whether the power is correctly connected.
- 2) Check whether the power key is really pressed.
- 3) Restart the instrument after finishing the above inspections.
- 4) If it still does not work correctly, please contact **RIGOL**.

2. The screen is too dark to see the contents on the screen clearly:

- 1) Check whether the brightness and contrast settings are too low.
- 2) Press **Utility** → **System** → **Display** to enter the display setting menu. Press **Bright** and **contrast** and adjust the brightness and contrast of the screen to appropriate values using the numeric keyboard or direction keys and knob respectively.

3. The generator is locked:

- 1) Check whether the generator is working in remote mode (in remote mode,  is displayed in the status bar of the user interface). Press **Help** to exit the remote control mode and unlock the front panel.
- 2) Restarting the generator can also unlock the generator.

4. The settings are correct but no waveform is generated:

- 1) Check whether the BNC cable is connected to the corresponding channel output terminal (**[CH1]** or **[CH2]**) tightly.
- 2) Check whether the BNC cable has internal damage.
- 3) Check whether the BNC cable is connected to the test instrument tightly.
- 4) Check whether the backlight of **Output1** or **Output2** is turned on. If not, press the corresponding key to illuminate the backlight.
- 5) After finishing the above inspections, press **Utility** → **System** → **Power On** to select "Last" and then restart the instrument.
- 6) If it still does not work correctly, please contact **RIGOL**.

5. The USB storage device cannot be recognized:

- 1) Check whether the USB storage device can work normally when connected to other instruments or PC.
- 2) Make sure that the USB storage device is flash type. The generator doesn't support hardware USB storage device.

- 3) Restarting the instrument and insert the USB storage device again to check whether it can work normally.
- 4) If the USB storage device still can not be used normally, please contact **RIGOL**.

6. How to set the amplitude of the waveform in dBm?

- 1) Press **CH1 | CH2** to select the desired channel.
- 2) Press **Utility** → **Channel Set** → **Output Set** → **Imped** to check whether the setting is "HighZ". If yes, you can not set the amplitude of the waveform in dBm at this time. Press **Imped** to select "Load" and use the numeric keyboard or direction keys and knob to set the impedance to a proper value.
- 3) Select the desired waveform, press **Ampl/HiLevel** to highlight "Ampl", and then input the desired value using the numeric keyboard. Then select the unit "dBm" from the pop-up menu.

7. Performance verification test is not passed:

- 1) Check whether the generator is within calibration period (1 year).
- 2) Check whether the generator is warmed up for at least 30 minutes before the test.
- 3) Check whether the generator is under the specified temperature.
- 4) Check whether the test is under strong-magnetism environment.
- 5) Check whether the power supplies of the generator and test system have strong interference.
- 6) Check whether the performance of the test device used meets the requirement.
- 7) Make sure that the test device used is within the calibration period.
- 8) Check whether the test devices used meets the required conditions of the manual.
- 9) Check whether all the connections are tight.
- 10) Check whether any cable has internal damage.
- 11) Make sure that the operations conform to settings and processes which are required by the performance verification manual.
- 12) Check whether the error calculation exits faults.
- 13) Correctly understand the definition of "typical value" for this product: the performance specification of this product under specified conditions.

Chapter 5 Specifications

Unless otherwise specified, all specifications can be guaranteed if the following two conditions are met.

- The generator is within the calibration period and has performed self-calibration.
- The generator has been working continuously for at least 30 minutes under the specified temperature (18°C ~ 28°C).

All the specifications are guaranteed unless those marked with “typical”.

Model	DG1032Z	DG1062Z
Channel	2	2
Maximum Frequency	30MHz	60MHz
Sample Rate	200MSa/s	
Waveforms		
Basic waveforms	Sine, Square, Ramp, Pulse, Noise	
Built-in Arbitrary Waveforms	160 kinds, including Sinc, Exponential Rise, Exponential Fall, ECG, Gauss, HaverSine, Lorentz, Dual-Tone, etc.	
Frequency Characteristics		
Sine	1μHz to 30MHz	1μHz to 60MHz
Square	1μHz to 15MHz	1μHz to 25MHz
Ramp	1μHz to 500kHz	1μHz to 1MHz
Pulse	1μHz to 15MHz	1μHz to 25MHz
Harmonic	1μHz to 10MHz	1μHz to 20MHz
Noise (-3dB)	30MHz bandwidth	60MHz bandwidth
Arbitrary Waveform	1μHz to 10MHz	1μHz to 20MHz
Resolution	1μHz	
Accuracy	±1ppm of the settings, 18°C to 28°C	
Sine Wave Spectrum Purity		
Harmonic Distortion	Typical (0dBm) DC-10MHz (included): <-65dBc 10MHz-30MHz (included): <-55dBc 30MHz-60MHz (included): <-50dBc	
Total Harmonic Distortion	<0.075% (10Hz-20kHz, 0dBm)	
Spurious (non-harmonic)	Typical (0dBm) ≤10MHz: <-70dBc >10MHz: <-70dBc+6dB/octave	
Phase Noise	Typical (0dBm, 10kHz deviation) 10MHz: <-125dBc/Hz	

Signal Characteristics	
Square	
Rise/Fall Time	Typical (1Vpp) <10ns
Overshoot	Typical (100KHz, 1Vpp) ≤5%
Duty Cycle	0.01% to 99.99% (limited by the current frequency setting)
Non-symmetry	1% of period+5ns
Jitter (rms)	Typical (1MHz, 1Vpp, 50Ω) ≤5MHz: 2ppm+200 ps >5MHz: 200ps
Ramp	
Linearity	≤1% of peak output (typical, 1kHz, 1Vpp, 100% Symmetry)
Symmetry	0% to 100%
Pulse	
Pulse Width	16ns to 999.999 982 118ks (limited by the current frequency setting)
Duty Cycle	0.001% to 99.999% (limited by the current frequency setting)
Leading/Trailing Edge Time	≥10ns (limited by the current frequency and pulse width settings)
Overshoot	Typical (1Vpp) ≤5%
Jitter (rms)	Typical (1Vpp) ≤5MHz: 2ppm+200ps >5MHz: 200ps
Arb	
Waveform Length	8Sa to 8Mpts (16Mpts optional)
Vertical Resolution	14bits
Sample Rate	200MSa/s
Minimum Rise/Fall Time	Typical (1Vpp) <5ns
Jitter (rms)	Typical (1Vpp) ≤5MHz: 2ppm+200ps >5MHz: 200ps
Edit Method	Edit Points, Edit Block, Insert Waveform
Harmonic	
Harmonic Order	≤8
Harmonic Type	Even, Odd, All, User
Harmonic Amplitude	can be set for all harmonics
Harmonic Phase	can be set for all harmonics

Output Characteristics	
Amplitude (into 50 Ω)	
Range	≤10MHz: 1.0mVpp to 10Vpp ≤30MHz: 1.0mVpp to 5.0Vpp ≤60MHz: 1.0mVpp to 2.5Vpp
Accuracy	Typical (1kHz Sine, 0V Offset, >10mVpp, Auto) ±1% of setting ± 1mV
Flatness	Typical (Sine 2.5Vpp) ≤10MHz: ±0.1dB ≤60MHz: ±0.2dB
Units	Vpp, Vrms, dBm
Resolution	0.1mVpp or 4digits
Offset (into 50 Ω)	
Range (Peak ac+dc)	±5Vpk ac+dc
Accuracy	±(1% of setting+5mV+0.5% of amplitude)
Waveform Output	
Impedance	50Ω (typical)
Protection	Short-circuit protection, automatically disable waveform output when overload occurs
Modulation Characteristics	
Modulation Type	AM, FM, PM, ASK, FSK, PSK, PWM
AM	
Carrier Waveform	Sine, Square, Ramp, Arb (except DC)
Source	Internal/External
Modulating Waveform	Sine, Square, Ramp, Noise, Arb
Depth	0% to 120%
Modulating Frequency	2mHz to 1MHz
FM	
Carrier Waveform	Sine, Square, Ramp, Arb (except DC)
Source	Internal/External
Modulating Waveform	Sine, Square, Ramp, Noise, Arb
Modulating Frequency	2mHz to 1MHz
PM	
Carrier Waveform	Sine, Square, Ramp, Arb (except DC)
Source	Internal/External
Modulating Waveform	Sine, Square, Ramp, Noise, Arb
Phase Deviation	0° to 360°
Modulating Frequency	2mHz to 1MHz
ASK	
Carrier Waveform	Sine, Square, Ramp, Arb (except DC)
Source	Internal/External
Modulating Waveform	Square with 50% duty cycle
Key Frequency	2mHz to 1MHz

FSK	
Carrier Waveform	Sine, Square, Ramp, Arb (except DC)
Source	Internal/External
Modulating Waveform	Square with 50% duty cycle
Key Frequency	2mHz to 1MHz
PSK	
Carrier Waveform	Sine, Square, Ramp, Arb (except DC)
Source	Internal/External
Modulating Waveform	Square with 50% duty cycle
Key Frequency	2mHz to 1MHz
PWM	
Carrier Waveform	Pulse
Source	Internal/External
Modulating Waveforms	Sine, Square, Ramp, Noise, Arb
Width Deviation	0% to 100% of Pulse Width
Modulating Frequency	2mHz to 1MHz
[Mod/Trig/FSK/Sync] Input	
Input Range	75mVRMS to $\pm 5V_{ac} + dc$
Input Bandwidth	50kHz
Input Impedance	1000 Ω
Burst Characteristics	
Carrier Waveform	Sine, Square, Ramp, Pulse, Noise, Arb (except DC)
Carrier Frequency	2mHz to 30MHz 2mHz to 60MHz
Burst Count	1 to 1,000,000 or Infinite
Start/Stop Phase	0° to 360°
Internal Period	1us to 500s
Gated Source	External Trigger
Trigger Source	Internal, External or Manual
Trigger Delay	0ns to 100s
Sweep Characteristics	
Carrier Waveform	Sine, Square, Ramp, Arb (except DC)
Type	Linear, Log or Step
Direction	Up/Down
Start/Stop Frequency	Consistent with the upper/lower limit of the frequency of the carrier waveform
Sweep Time	1ms to 500s
Hold/Return Time	0ms to 500s
Trigger Source	Internal, External or Manual
Mark	Falling edge of the Sync signal (programmable)

Counter			
Function	Frequency, Period, Positive/Negative Pulse Width, Duty Cycle		
Frequency Resolution	7 digits/second (Gate Time = 1s)		
Frequency Range	1 μ Hz to 200MHz		
Period Measurement	Measurement Range	5ns to 16 days	
Voltage Range and Sensitivity (Not modulation signal)			
DC Coupling	DC Offset Range	± 1.5 Vdc	
	1 μ Hz to 100MHz	50mVRMS to ± 2.5 Vac+dc	
	100MHz to 200MHz	100mVRMS to ± 2.5 Vac+dc	
AC Coupling	1 μ Hz to 100MHz	50mVRMS to ± 2.5 Vpp	
	100MHz to 200MHz	100mVRMS to ± 2.5 Vpp	
Pulse Width and Duty Cycle Measurement			
Frequency/Amplitude Range	1 μ Hz to 25MHz	50mVRMS to ± 2.5 Vac+dc	DC Coupling
Pulse Width	Minimum	≥ 20 ns	
	Resolution	5ns	
Duty Cycle	Range (Display)	0% to 100%	
Input Characteristics			
Input Signal Range	Breakdown Voltage	± 7 Vac+dc	Impedance=1M Ω
Input Adjustment	Coupling	AC	DC
	HF Suppression	ON: input bandwidth=250kHz; OFF: input bandwidth=200MHz	
Input Trigger	Trigger Level Range	-2.5V to +2.5V	
	Trigger Sensitivity Range	0% (about 140mV hysteresis voltage) to 100% (about 2mV hysteresis voltage)	
Gate Time	GateTime1	1.310ms	
	GateTime2	10.48ms	
	GateTime3	166.7ms	
	GateTime4	1.342s	
	GateTime5	10.73s	
	GateTime6	>10s	
Trigger Characteristics			
Trigger Input			
Level	TTL-compatible		
Slope	Rising or falling (optional)		
Pulse Width	>100ns		
Latency	Sweep: <100ns (typical) Burst: <300ns (typical)		
Trigger Output			
Level	TTL-compatible		

Pulse Width	>60ns (typical)
Maximum Frequency	1MHz
Clock Reference	
Phase Offset	
Range	0° to 360°
Resolution	0.03°
External Reference Input	
Lock Range	10MHz±50Hz
Level	250mVpp to 5Vpp
Lock Time	<2s
Impedance (typical)	1kΩ, AC coupling
Internal Reference Output	
Frequency	10MHz±50Hz
Level	3.3Vpp
Impedance (typical)	50Ω, AC coupling
Sync Output	
Level	TTL-compatible
Impedance	50Ω, nominal value
Overvoltage Protection	
Overvoltage protection will take effect once any of the following two conditions is met:	
<ul style="list-style-type: none"> ● The amplitude setting in the generator is greater than 2Vpp or the output offset is greater than $2V_{DC}$, the input voltage is greater than $\pm 11.5 \times (1 \pm 5\%)V$ (<10kHz). ● The amplitude setting in the generator is lower than or equal to 2Vpp or the output offset is lower than or equal to $2V_{DC}$, the input voltage is greater than $\pm 3.5 \times (1 \pm 5\%)V$ (<10kHz). 	
General Specifications	
Power	
Power Voltage	100V to 240V (45Hz to 440Hz)
Power Consumption	Less than 40W
Fuse	250V, T3.15A
Display	
Type	3-inch TFT LCD
Resolution	320 Horizontal×RGB×240 Vertical Resolution
Color	16M color
Environment	
Temperature Range	Operating: 0°C to 50°C Non-Operating: -40°C to 70°C
Cooling Method	Cooling by fans compulsively

Humidity Range	Less than 30°C: ≤95% Relative Humidity (RH) 30°C to 40°C: ≤75% Relative Humidity (RH) 40°C to 50°C: ≤45% Relative Humidity (RH)	
Altitude	Operating: Less than 3000 meters Non-Operating: Less than 15,000 meters	
Mechanical		
Dimensions (W×H×D)	261.5mm×112mm×318.4mm	
Weight	without package: 3.2kg with package: 4.5kg	
Interfaces	USB Host, USB Device, LAN	
IP Protection	IP2X	
Calibration Interval	Recommend calibration interval is one year	
Authentication Information		
EMC	In line with EN61326-1:2006	
	IEC 61000-3-2:2000	±4.0kV (Contact Discharge) ±4.0kV (Air Discharge)
	IEC 61000-4-3:2002	3V/m (80MHz to 1GHz) 3V/m (1.4GHz to 2GHz) 1V/m (2.0GHz to 2.7GHz)
	IEC 61000-4-4:2004	1kV power lines
	IEC 61000-4-5:2001	0.5kV (Phase to Neutral) 0.5kV (Phase to PE) 1kV (Neutral to PE)
	IEC 61000-4-6:2003	3V, 0.15-80MHz
	EC 61000-4-11:2004	Voltage dip: 0%UT during half cycle 0%UT during 1 cycle 70%UT during 25 cycle Short interruption: 0%UT during 1 cycle
Electrical Safety	In line with USA: UL 61010-1:2012, Canada: CAN/CSA-C22.2 No. 61010- 1-2012 EN 61010-1:2010	

Chapter 6 Appendix

Appendix A: Accessories and Options

	Description	Order Number
Model	DG1032Z (30MHz, Dual-channel)	DG1032Z
	DG1062Z (60MHz, Dual-channel)	DG1062Z
Standard Accessories	Power Cord	-
	USB Cable	CB-USBA-USBB-FF-150
	BNC Cable	CB-BNC-BNC-MM-100
	Quick Guide	-
	Resource CD (including the User's Guide, etc.)	-
	Warranty Card	-
Options	16M Internal Memory	Arb16M-DG1000Z
	Rack Mount Kit (for single instrument)	RM-1-DG1000Z
	Rack Mount Kit (for dual instruments)	RM-2-DG1000Z
	40dB Attenuator	RA5040K
	10W Power Amplifier	PA1011
	USB to GPIB Interface Converter	USB-GPIB

Note: all the standard accessories and options can be ordered from you local **RIGOL** Office.

Appendix B: Specifications of Power Amplifier

Unless otherwise specified, all specifications can be guaranteed if the following two conditions are met.

- The generator has been working continuously for 30 minutes at specified temperature.
- All the specifications are guaranteed unless those marked with “typical”.

Signal Input	
Input Impedance	50k Ω
Built-in Bias Voltage (Output Equivalent)	+/-12V
External Input	+/-10Vmax (Gain: X1) +/-1.25Vmax (Gain: X10)
Power Amplifier Specifications	
Running Mode	Constant Voltage
Gain	Switch between 10V/1V and 10V/10V (DC Gain Error: <5%)
Polarity Switch	Normal/Invert
Effective Value of Sine Output Power (RL=7.5 Ω)	10W (typical value, input Sine, 100kHz, X10)
Output Voltage	12.5V _{peak} (input Sine, 100kHz)
Output Current	1.65A _{peak} (input Sine, 100kHz)
Output Impedance	<20 Ω
Full Power Bandwidth ^[1]	DC ~ 1MHz
Output Slew Rate ^[2]	$\geq 80\text{V}/\mu\text{s}$ (typical)
Overshoot	<7%
Bias Voltage Specification	
Bias Voltage Gain Error	5% \pm 100mV
Others	
Power Supply	DC 12V \pm 5%, 4A _{peak}
Output Protection	Output Overcurrent Protection, Internal Temperature Abnormity Protection
Operating Temperature ^[3]	0 $^{\circ}\text{C}$ to +35 $^{\circ}\text{C}$
Dimensions (W \times H \times D)	142.2mm \times 48.1mm \times 215.4mm
Net Weight	850g \pm 20g

Note^[1]:

Full power bandwidth refers to the maximum frequency when the power amplifier can generate AC output with the maximum possible amplitude and without distortion.

$$\text{Full power bandwidth } FPB = \frac{SR}{2\pi V_{\max}}$$

SR: Slew Rate (output slew rate)

V_{max}: the maximum amplitude without distortion that the amplifier can output

Note^[2]:

Definition of Slew Rate: input a large step-function signal into the amplifier, the output slope of the signal is saturated to a constant at a certain position. This constant is called the Slew Rate of the amplifier.

Note^[3]:

The specifications above are all specifications under 25°C. The range of the environment temperature for PA1011 is from 0°C to +35°C and when the environment temperature is greater than 35°C, it is recommended that users reduce the output power and the working frequency of PA1011.

Appendix C: Warranty

RIGOL warrants that its products mainframe and accessories will be free from defects in materials and workmanship within the warranty period.

If a product is proven to be defective within the respective period, **RIGOL** guarantees the free replacement or repair of products which are approved defective. To get repair service, please contact with your nearest **RIGOL** sales and service office.

RIGOL does not provide any other warranty items except the one being provided by this summary and the warranty statement. The warranty items include but not being subjected to the hint guarantee items related to tradable characteristic and any particular purpose. **RIGOL** will not take any responsibility in cases regarding to indirect, particular and ensuing damage.

Index

*.RAF	2-75	Frequency Deviation	2-41
*.RSF	2-75	Frequency Modulation.....	2-39
Align Phase	2-9	Frequency Output Mode.....	2-18
Amplitude	2-5	Frequency Shift Keying	2-48
Amplitude Coupling.....	2-90	Frequency Span	2-58
Amplitude Modulation.....	2-35	Gate Time	2-71
Amplitude Shift Keying	2-45	Gated Burst	2-66
Arb File.....	2-75	Gated Polarity	2-67
Auto	2-22	GPIO Address.....	2-103
AutoIP	2-105	Harmonic.....	2-30
Bioelectricity.....	2-21	Harmonic Amplitude	2-32
Bmp File	2-76	Harmonic Order	2-31
Built-In Waveform.....	2-20	Harmonic Phase	2-32
Burst	2-65	Harmonic Type.....	2-31
Burst Delay	2-68	High-Frequency Suppression	2-73
Burst Period	2-67	Infinite Burst	2-66
Carrier Waveform Suppression ...	2-38	Insert Waveform	2-27
Center Frequency	2-58	ITF	2-23
Channel Copy	2-93	Leading Edge.....	2-13
Clock Source	2-100	Linear Sweep.....	2-59
Counter	2-70	Log Sweep.....	2-59
Coupling	2-73	MAC Address	2-104
Csv File.....	2-76	ManualIP.....	2-105
Data Source	2-27	Mark Frequency	2-61
DC Offset.....	2-7	Medical	2-22
Default Gateway	2-106	MF.....	2-22
Delete	2-80	Modulating Polarity.....	2-47
DF.....	2-23	Modulation	2-21
DHCP.....	2-105	Modulation Depth.....	2-37
DNS Service	2-106	N Cycle	2-65
Dual Channels Graph.....	1-16	Network Status	2-104
Dual Channels Parameters	1-16	Normal.....	2-20
Duty Cycle	2-10	Output Set.....	2-87
Duty Cycle Deviation	2-56	Overvoltage Protection.....	1-6
Edit Block.....	2-29	Phase Coupling	2-91
Edit Mode	2-26	Phase Deviation	2-44
Edit Points.....	2-28	Phase Modulation	2-42
Engine.....	2-21	Phase Shift Keying.....	2-51
External Power Amplifier	2-109	Print.....	2-108
Factory Default Values.....	2-94	Pulse Width	2-12
Filter	2-21	PWM.....	2-54
Frequency.....	2-4	Return Time.....	2-60
Frequency Coupling	2-90	Sample Rate Output Mode.....	2-18

Seamless Interconnection.....	2-81	Sync Output	2-84
SiFi (Signal Fidelity)	X	Test/Calibration.....	2-108
Signal.....	2-21	TF	2-23
Single Channel View	1-16	To Copy File.....	2-79
Start Frequency.....	2-57	To Paste File	2-80
Start Hold	2-61	To Read File.....	2-79
Start Phase	2-8	To Save File	2-77
State File	2-75	Track	2-93
Statistic Function	2-71	Trailing Edge.....	2-13
Step Sweep.....	2-60	Trigger Sensitivity.....	2-73
Stop Frequency	2-57	Txt File	2-76
Stop Hold	2-62	USB Host.....	1-5
Stored Waveform.....	2-24	User-defined Start-up Interface	2-102
Subnet Mask	2-106	VISA Descriptor	2-104
Sweep	2-57	Volatile Waveform	2-25
Sweep Time	2-60	Waveform Summing	2-89
Sweep Trigger Source	2-62	WF	2-24
Symmetry	2-11	Width Deviation	2-56